

SPECIAL AUDIO ISSUE

RADIO & TELEVISION NEWS

ANC

NOVEMBER

1950

35¢

In Canada 40¢



Audio
**DEMONSTRATION SIMPLIFIED
BY USING CONTROL CONSOLE**

PAGE 50

Now... the new RC-16

RCA RECEIVING TUBE MANUAL

- ✓ Up-to-the-minute
- ✓ Over 300 pages
- ✓ Latest TV tube data
- ✓ Over 460 tube types
- ✓ "Lio-Rat" binding
- ✓ Expanded circuit section

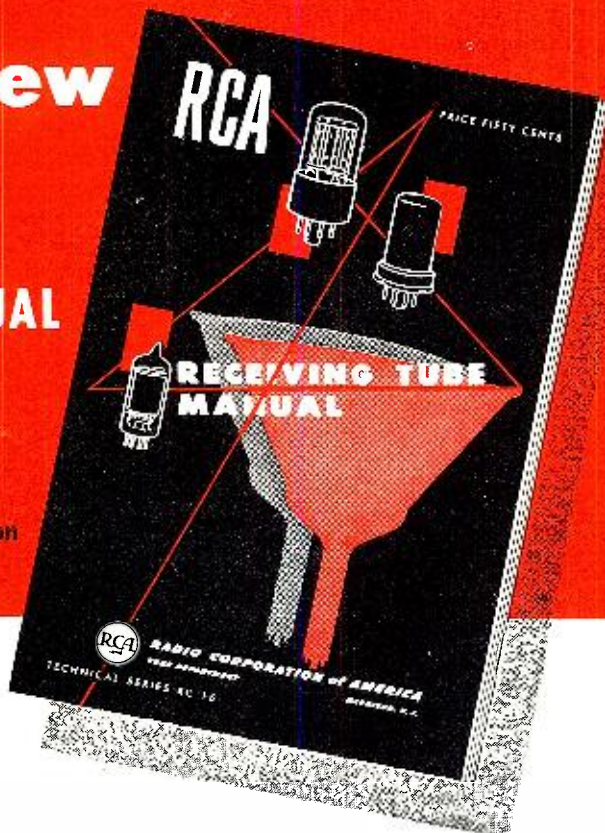

... you should have these other "RCA firsts"
in authoritative technical literature



Receiving Tubes for AM, FM, and Television Broadcast
Bulletin 1275-E.
Characteristics and base diagrams on over 450 RCA receiving tubes. 24 pages. Price 10 cents.

New RCA Triple Pindex
At your fingertips... any 3 base diagrams out of over 600 receiving tubes and kinescopes. Price 75 cents.



Months of planning and preparation went into the new RC-16 Receiving Tube Manual to produce what is unquestionably the most complete and authoritative reference guide to receiving-type tubes ever published.

Patterned after the famous RC-15—of which over 600,000 copies were sold—and retaining its proven features, the new and larger RC-16 contains over 300 pages of detailed information on more than 460 RCA receiving tubes and kinescopes.

Features include—

... tube and circuit theory with formulas and examples for calculating power output, load resistance, and distortion for several classes of amplifiers—plus new information on cathode follower design.

... new information on kinescope installation and handling.

... a classification chart which groups types having similar characteristics and the same filament or heater voltages. Also shows miniature types and their GT equivalents.

... expanded circuit section including many new audio amplifier and receiver designs.

... design data and charts for resistance-coupled amplifiers.

✓ ✓ ✓

A textbook in itself, the new RC-16 is the most valuable day-to-day tube reference guide in the field... yet it costs only 50 cents! **Get your copy today from your local RCA Tube Distributor.**

RCA Television Pict-O-Guides For quick and accurate TV trouble shooting by picture analysis. (See your RCA Tube Distributor for details.)

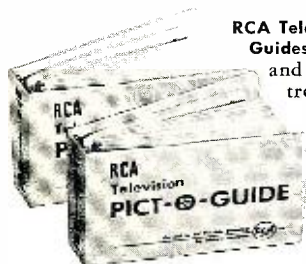

For quick action—

----- Mail this coupon to your **RCA TUBE DISTRIBUTOR** * -----

Mr. RCA Tube Distributor:
Please rush me RCA Technical Literature checked below for which remittance is enclosed—

Name _____

Address _____

City _____ Zone _____ State _____

- RC-16 RCA Receiving Tube Manual (50 cents) Receiving Tubes for AM, FM, and TV (10 cents)
- RCA Triple Pindex, New Edition (75 cents) Tell me how I can obtain Volume I Volume II of the RCA Pict-O-Guide.



**RADIO CORPORATION
of AMERICA**

ELECTRON TUBES HARRISON, N. J.

*If you do not know your RCA Tube Distributor, orders may be sent to RCA, Commercial Engineering, Section K52U, Harrison, N. J.

NEW



I'LL TRAIN YOU FOR YOUR FCC LICENSE

A Federal Communications Commission Commercial Operator's License puts you in line for a good job in Radio or Television Broadcasting, Police, Marine, Aviation, Two-way, Mobile or Micro-wave Relay Radio. Mail coupon below for 64-page book FREE. It will give you complete facts about my NEW Communications course.



YOU BUILD THIS TRANSMITTER

with parts I send. With this Transmitter you practice how to put a station "on the air." You perform procedures demanded of Broadcast Station Operators, conduct many experiments, make many practical tests.

LEARN COMMUNICATIONS by PRACTICING at Home in Spare Time

with MANY KITS of

RADIO EQUIPMENT I SEND

Ever think HOW FAST Radio-Television Communications is changing, developing, growing? Have you considered what this amazing progress can mean to you?

Look at these facts. In 1946 only 6,000 Television sets were sold. In 1949 almost 3,000,000. By 1954, 20,000,000 Television sets will be in use, according to estimates. 100 Television Stations are operating in 35 states. Authorities predict there will be over 1,000 Television Stations. This rapid growth means new jobs, more jobs, good pay for qualified men all over the U. S. and Canada. Then add development of FM, Two-way Radio, Police, Marine, Aviation and Micro-wave Relay Radio! Think what all this means! New jobs, more jobs for beginners! Better jobs, better pay for experienced men!

Are you a beginner who wants steady work in this growing field? My NEW course can help you get an FCC License and prepare for the job you want. Are you a man with some training in Radio or Radar, or a Licensed Operator? My NEW course modernizes, increases the value of your knowledge and experience!

MY COURSE INCLUDES TELEVISION

Course Is New! Different!

Mail coupon now for facts about my NEW, intensely practical course in Radio-Television Communications. Let me send you FREE book. Read outlines of 78 lesson texts written by leaders in Communications and edited for you by my practical staff. See the nine big Kits of Parts I send that "bring to life" theory you learn. Read about the Transmitter you build and operate, about the Electronic Multitester you get. All equipment yours to keep. My NEW course covers Theory thoroughly and you get Practical Experience building units like those shown at the left. It's backed by N. R. I.—the world's oldest and largest home study Radio-Television school.

Mail Coupon For Book FREE

Send today! See what my NEW course is like. Find out how I get you ready for a brighter future, better earnings, more security in Radio-Television. Send coupon now in envelope or paste on a postal. NO OBLIGATION. NO SALESMAN WILL CALL! My book, sent to you FREE, tells the full story. J. E. SMITH, President, Dept. OMR, National Radio Institute, Washington 9, D. C.

Servicing Training Also Offered by N. R. I.

If you prefer a good-pay job in Radio-Television Servicing . . . or your own money-making Radio-Television Sales and Service Shop, I'll train you at home. My famous Servicing Course also includes many Kits of Radio Parts. You use them to get PRACTICAL EXPERIENCE with circuits common to Radio and Television. I also show you how to make \$5, \$10 a week or more EXTRA MONEY fixing neighbors' Radios while training. Full information in my 64-page book. . . . Mail coupon.

MAIL NOW-BOOK FREE

MR. J. E. SMITH, President, Dept. OMR
National Radio Institute, Washington 9, D. C.

Mail me your 64-page Book about Radio and Television Communications opportunities and training. (No salesman will call. Please write plainly.)

Name.....Age.....
Address.....
City.....Zone.....State.....
 Check if Veteran Approved Under G. I. Bill

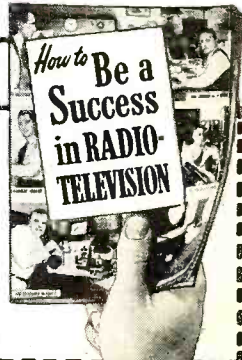

YOU BUILD this Transmitter Power Supply used in the basic experiments in RF and AF amplifiers, frequency multipliers, buffers, etc.

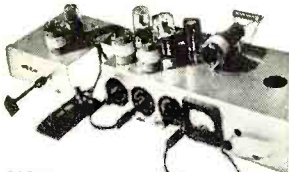

YOU PRACTICE setting up code, amplitude and frequency modulation circuits (put voice, music, etc., on "carrier signals" you produce). You learn how to get best performance.

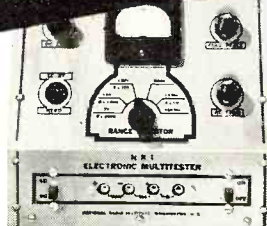

YOU MEASURE current, voltage (AC, DC and RF), resistance and impedance in circuits with Electronic Multitester you build. Shows how basic transmitter circuits behave; needed to maintain station operation.

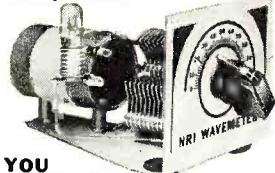

YOU BUILD this Wavemeter and use it to determine frequency of operation, make other tests on transmitter currents.

VETERANS

HURRY!

To get this valuable training under G. I. Bill. Time is Running out. MAIL COUPON NOW!

TRAINED THESE MEN



"N.R.I. has been my stepping stone from a few hundred to over \$4,000 a year as a Radio Engineer."—ALTON B. MICHAELS, Trenton, Georgia.



"I am employed by WKBO as transmitter operator. Have more than doubled salary since starting in Radio full time!"—A. H. HERR, New Cumberland, Penna.



"Am Broadcast Engineer at WLP. Your NEW Communications course shows the kind of equipment we use."—J. B. BANGLE, JR., Suffolk, Virginia.



"4 years ago, I was a book-keeper with hand-to-mouth salary. Am now Radio Engineer with ABC network."—N. H. WARD, Ridgefield Park, N. J.

Editor
OLIVER READ, D.Sc., D.Litt., W9ETJ
 Managing Editor
WM. A. STOCKLIN, B.S.
 Technical Editor
H. S. RENNE, M.S.
 Associate Editor
RAY FRANK, W9JU

Contributing Editor
R. HERTZBERG, W2DJJ
 Television Consultant
MILTON S. KIVER
 Short-Wave Editor
KENNETH R. BOORD

Editorial Assistants
I. M. CARROLL
E. V. HITZEL
P. B. HOEFER

Staff Artist
R. S. KUPJACK

Advertising Manager
L. L. OSTEN

Midwest Adv. Manager
JOHN A. RONAN, JR.

Art Director
HERMAN R. BOLLIN

RADIO & TELEVISION NEWS

First in
radio-television-electronics

Average Paid Circulation over 200,000

Radio News Trademark Reg. U.S. Pat. Office No. 521506 • Television News Trademark Reg. U.S. Pat. Office No. 517468
 Radio & Television News Trademark Reg. U.S. Pat. Office No. 517023

CONTENTS

NOVEMBER, 1950

Problems in Phonograph Record Reproduction.....	John D. Goodell	39
A Flexible Record-Reproduce System (Part I).....	Oliver Read	42
How To Judge Audio Quality.....	Joseph Marshall	44
A Two-Channel Magnetic Recording Amplifier.....	Lloyd B. Hust	45
A Self-Equalizing Preamp.....	J. Carlisle Hoadley	48
The "Auditioner".....	L. M. Dezettel	50
A Flexible General Purpose Amplifier.....	J. N. A. Hawkins	52
Controlling Hum in Audio Amplifiers.....	Lawrence Fleming	55
A High-Quality Sound System for the Home.....	H. F. Olson & A. R. Morgan	59
An Electronic Loss Compressor.....	E. C. Miller & Tad Jones	64
Your Stake in the Color Decision.....	Milton S. Kiver	65
A 3-Channel Unitary Loudspeaker.....	D. J. Plach & P. B. Williams	66
An RC Beat-Frequency Oscillator.....	Richard H. Dorf	68
An Unusual Public Address System.....	Glen Southworth	71
Sound on Wheels.....	Lawrence J. Epstein	74
Selecting Your High-Fidelity System.....	James F. Becker	80
Mac's Radio Service Shop.....	John T. Frye	82
Let's Put Square Waves To Work.....	Howard Anthony	83
Power Level and Volume Indicator Meters.....	H. M. Tremaine	84
The Mike on Matterhorn.....	Kenneth J. Henderson	106
The Ad-Viser (Part 3).....	Irving Settel	178



COVER PHOTO: Allied Radio Corp.'s "Auditioner." This special console allows various pieces of audio equipment to be combined so that the customer can make his selections easily. (Ektachrome by Dan Seikel)

Chairman of the Board and Publisher
WILLIAM B. ZIFF

President
B. G. DAVIS

Secretary-Treasurer
ARTHUR T. PULLEN

Vice-Presidents
MICHAEL H. FROELICH
 Dir. Eastern Div.

H. J. MORGANROTH
 Production Director

LYNN PHILLIPS, Jr.
 Advertising Director

H. G. STRONG
 Circulation Director

BRANCH OFFICES

NEW YORK (17)
 366 Madison Ave., MUrray Hill 7-8080

LOS ANGELES (14)
 815 S. Hill St., TUcker 9213
 Manager, WILLIAM L. PINNEY

DEPARTMENTS

For the Record.....	The Editor	8	New TV Products.....	130
Spot Radio News.....		16	New Audio Equipment.....	158
Within the Industry.....		24	MARS	170
Short-Wave.....	K. R. Boord	79	AFCA News	188
What's New in Radio.....		101	Manufacturers' Literature	194
Technical Books		201		



COPYRIGHT 1950
 ZIFF-DAVIS PUBLISHING COMPANY
 185 North Wabash Ave., Chicago 1, Ill.
 VOLUME 44 • NUMBER 5



Member
 Audit Bureau of
 Circulations

RADIO & TELEVISION NEWS is published monthly by the Ziff-Davis Publishing Company at 185 N. Wabash Ave., Chicago 1, Ill. Entered as second-class matter July 21, 1948, at the Post Office, Chicago, Ill., under the act of March 3, 1879. Entered as second-class matter at the Post Office Department, Ottawa, Canada. SUBSCRIPTION RATES: in U. S., Canada, Mexico, South and Central America and U. S. Possessions, \$4.00 for twelve issues; in British Empire \$5.00; all other foreign countries, \$5.00 for twelve issues. RADIO-ELECTRONIC ENGINEERING EDITION SUBSCRIPTION RATES: in U. S., Canada, Mexico, South and Central America and U. S. Possessions, \$6.00 for twelve issues; in British Empire \$7.00; all other foreign countries, \$7.00 for twelve issues. Subscribers should allow at least two weeks for change of address. All communications about subscriptions should be addressed to the Director of Circulation, 185 N. Wabash Ave., Chicago 1, Ill. CONTRIBUTIONS: Contributors are advised to retain a copy of their manuscripts and illustrations. Contributions must be accompanied by return postage and they will be handled with reasonable care, but this magazine assumes no responsibility for their safety. Any copy accepted is subject to whatever adaptations and revisions are necessary to meet the requirements of this publication. Payment covers all author's, contributor's and contestant's rights, title, and interest in and to the material accepted and will be made at our current rates upon acceptance. All photos and drawings will be considered as part of the material purchased.

RADIO & TELEVISION NEWS

Six Months from Today Which will YOU hold?

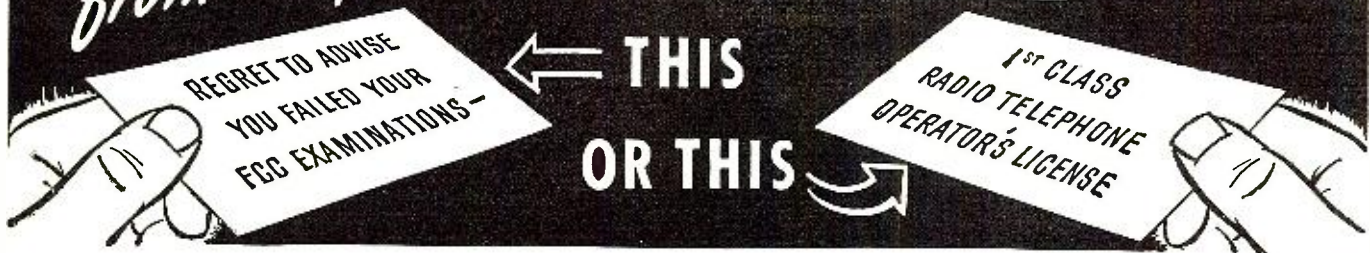

WANT YOUR FCC COMMERCIAL LICENSE IN A HURRY?

Add Technical Training to your Practical Experience and Get Your "Ticket" in a MINIMUM OF TIME
It's EASY When You Use CIRE Simplified Training and Coaching AT HOME in SPARE TIME

Thousands of new jobs are opening up—FM, Television, Mobile Communication Systems. These are only a few of the radio fields which require licensed radio technicians and operators. Get your license without delay. Let Cleveland

Institute prepare you to pass FCC license examinations, and hold the jobs which a license entitles you to, with CIRE streamlined, post-war methods of coaching and training.



TELLS HOW —

WE GUARANTEE TO TRAIN AND COACH YOU AT HOME IN SPARE TIME UNTIL YOU GET YOUR FCC LICENSE

If you have had any practical experience—Amateur, Army, Navy, radio repair, or experimenting.

TELLS HOW —

Employers Make JOB OFFERS Like These to Our Graduates Every Month

Telegram, August 9, 1950, from Chief Engineer, Broadcast Station, Pennsylvania, "Have job opening for one transmitter operator to start immediately, contact me at once."

Letter, August 12, 1950, from Dir. Radio Div. State Highway Patrol, "We have two vacancies in our Radio Communication Division. Starting pay \$200; \$250 after six months' satisfactory service. Will you recommend graduates of your school?"

These are just a few examples of the job offers that come to our office periodically. Some licensed radioman filled each of these jobs . . . it might have been you!

HERE'S PROOF FCC LICENSES ARE OFTEN SECURED IN A FEW HOURS OF STUDY with OUR Coaching at HOME in Spare Time

Name and Address	License	Lessons
Lee Worthy 2210 1/2 Wilshire St., Bakersfield, Cal.	2nd Phone	16
Clifford E. Vogt Box 1016, Dania, Fla.	1st Phone	20
Francis X. Foerch 33 Beutler Pl., Berginfield, N. J.	1st Phone	38
S/Sgt. Ben H. Davis 317 North Roosevelt, Lebanon, Ill.	1st Phone	28
Albert Schoell 110 West 11th St., Escondido, Cal.	2nd Phone	23

CLEVELAND INSTITUTE OF RADIO ELECTRONICS
Desk RN-23, 4900 Euclid Bldg., Cleveland 3, Ohio
(Approved for Veteran Training Under G. I. Bill.)

November, 1950

TELLS HOW —

Our Amazingly Effective JOB FINDING SERVICE Helps CIRE Students Get Better Jobs

Here are a few recent examples of Job-Finding Results

GETS FIVE JOB-OFFERS FROM BROADCAST STATIONS
"Your 'Chief Engineer's Bulletin' is a grand way of obtaining employment for your graduates who have obtained their 1st class license. Since my name has been on the list I have received calls or letters from five stations in the southern states, and am now employed as Transmitter Engineer at WMMT."
Elmer Powell, Box 274, Sparta, Tenn.

GETS CIVIL SERVICE JOB
"I have obtained a position at Wright-Patterson Air Force Base, Dayton, Ohio, as Junior Electronic Equipment Repairman. The Employment Application you prepared for me had a lot to do with my landing this desirable position."
Charles E. Loomis, 4516 Genesee Ave., Dayton 6, Ohio.

GETS JOB WITH CAA
or so offers since I mailed some fifty of the two hundred employment applications your school forwarded me. I accepted a position with the Civil Aeronautics Administration as Maintenance Technician. Thank you very much for the fine cooperation and help your organization has given me in finding a job in the radio field."
Dale E. Young, 122 Robbins St., Owosso, Mich.

OURS IS THE ONLY HOME STUDY COURSE WHICH SUPPLIES FCC-TYPE EXAMINATIONS WITH ALL LESSONS AND FINAL TESTS.

Your FCC Ticket is always recognized in all radio fields as proof of your technical ability.

Get All 3 FREE

MAIL COUPON NOW

Cleveland Institute of Radio Electronics
Desk RN-23, 4900 Euclid Bldg., Cleveland 3, Ohio
(Address to Desk No. to avoid delay)

I want to know how I can get my FCC ticket in a minimum of time. Send me your FREE booklet, "How to Pass FCC License Examinations" (does not cover exams for Amateur License), as well as a sample FCC-type exam and the valuable new booklet, "Money-Making FCC License Information."

NAME

ADDRESS

CITY ZONE STATE

Veterans check for enrollment information under G. I. Bill.

NEW INDICATOR ION TRAP

Now in all
**Rauland
Tubes**



The response to Rauland's new Indicator Ion Trap, after its introduction in the 12LP4-A, has been so enthusiastic that this feature has now been incorporated in all Rauland tubes—as a standard feature of the new Rauland Tilted Offset Gun.

In the field or on the assembly line, this new Indicator Ion Trap reduces Ion Trap Magnet adjustment time to a matter of seconds, eliminates mirrors and guesswork, and assures accuracy of magnet adjustment. It can increase profits for every service man and service dealer—and at the same time assure better customer satisfaction.

A bright green glow on the anode of the picture tube signals when adjustment is incorrect. Correct adjustment is made instantly, by moving the magnet until the glow is extinguished or reduced to minimum.

Only Rauland offers this advanced feature—one of a half-dozen important post-war developments from Rauland.

RAULAND

The first to introduce commercially these popular features:

- Tilted Offset Gun
- Indicator Ion Trap
- Luxide (Black) Screen
- Reflection-Proof Screen
- Aluminized Tube

THE RAULAND CORPORATION



Perfection Through Research

4245 N. KNOX AVENUE • CHICAGO 41, ILLINOIS



RADIO & TELEVISION NEWS

NOW... GET EVERYTHING YOU NEED TO LEARN AND MASTER **TELEVISION**

RADIO-ELECTRONICS ...AT HOME!

Use **REAL** commercial-type equipment to get practical experience

Your future deserves and needs every advantage you can give it! That's why you owe it to yourself to find out about one of the most COMPLETE, practical and effective ways now available to prepare AT HOME for America's billion dollar opportunity field of TELEVISION-RADIO-ELECTRONICS. See how you may get and keep the same type of basic training equipment used in one of the nation's finest training laboratories... how you may get real STARTING HELP toward a good job or your own business in Television-Radio-Electronics. Mail the coupon today for complete facts — including 89 ways to earn money in this thrilling, newer field.



Here's the **REAL THING!**

SET UP YOUR OWN HOME LABORATORY

ABOVE: Build and keep a real 16 INCH commercial TV receiver. Optional after completing regular training at slight additional cost.

D.T.I., ALONE, INCLUDES BOTH MOVIES and HOME LABORATORY

In addition to easy-to-read lessons, you get the use of HOME MOVIES — an outstanding training advantage — plus 16 big shipments of Electronic parts. Perform over 300 fascinating experiments for practical experience. Build and keep real commercial-type test equipment shown at left.

Get BOTH of these information packed publications FREE!

MODERN LABORATORIES

If you prefer, get all your preparation in our new Chicago Training Laboratories—one of the finest of its kind. Ample instructors, modern equipment. Write for details!

MILITARY SERVICE!

If you're subject to military service, the information we have for you should prove doubly interesting. Mail coupon today.

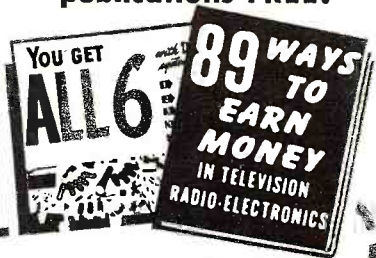

ACT NOW! MAIL COUPON TODAY!

DeFOREST'S TRAINING, INC., Dept. RN-G-11
2533 N. Ashland Ave., Chicago 14, Ill.

Without obligation, I would like your late News-Bulletin showing 89 ways to earn money in Television-Radio-Electronics... and how I may prepare to get started in this thrilling field.

Name..... Age.....
Street..... Apt.....
City..... Zone..... State.....

Oscilloscope
R-F Signal Generator

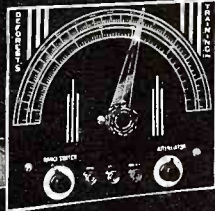

6-Tube Radio

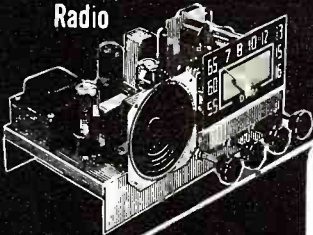

Multimeter

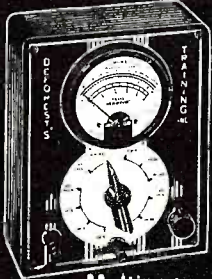

HOME MOVIES



De FOREST'S TRAINING, INC.
CHICAGO 14, ILLINOIS
A De VRY INSTITUTION



It's the newest convenience in soldering. *Twin Spotlights* on your new 135-watt WELLER Soldering Gun completely eliminate shadows; you see clearly even in the darkest chassis.

Pull the trigger of your WELLER Gun, heat and light come on together—in just 5 seconds! No more waiting, wasted current, or blind soldering. Your WELLER Gun pays for itself in a few months!



Specially Designed for TV and Radio Work

- **DUAL SOLDERLITE**—Two prefocused spotlights completely eliminate shadows—let you see clearly what you are soldering.
- **OVER/UNDER DESIGN**—Tube construction braces tip and improves visibility.
- **5-SECOND HEATING**—No waiting. Saves power. Pull the trigger and you solder!
- **LONGER REACH**—Slides easily into deep chassis, reaches the tightest corners.
- **GREATER CAPACITY**—Smaller, lighter, with greater soldering capacity.
- **TRIGGER-SWITCH CONTROL**—Adjusts heat to the job. Saves current—no need to unplug gun between jobs.
- **DUAL HEAT**—Single heat 100 watts; dual heat 100/135 watts; 120 volts, 60 cycles. Handles all light-duty soldering.

See new Models WS-100 and WD-135 at your distributor, or write for bulletin direct.

- **SOLDERING GUIDE**—Get your new copy of "Soldering Tips"—revised, up-to-date and fully illustrated 20-page booklet of practical soldering suggestions. Price 10¢ at your distributor, or order direct.



WELLER

ELECTRIC CORP.

810 Packer Street, Easton, Pa.

For the RECORD.

BY THE EDITOR

AT LEAST "MINIMUM SERVICE" ESSENTIAL TO TV'S FUTURE

THE editors of RADIO & TELEVISION NEWS have made an exclusive arrangement with the Television Technicians Lecture Bureau to bring to our radio and TV service technicians "on the spot" analysis of problems of the service industry.

As a sponsor of these nationwide educational programs, this magazine will serve as a medium for constructive action on matters vital to the welfare of the technician.

A new department, "Radio-TV Service Industry News," will be featured each month and will include information on business trends in the Service Industry as well as data on all other developments which are of interest to Radio-TV Service Shop operators and technicians.

Very serious problems face the entire Radio-TV Service Industry. Military demands for trained technicians must be satisfied of course. This means that technicians whose job it is to keep receivers going in millions of homes will be in great demand. Not nearly enough qualified men will remain to serve the civilian market. Many will be working in factories producing military electronic equipment.

The rate of reduction of potential service technicians is already quite alarming. Various Associations are reporting considerable loss of membership as qualified men become absorbed by Industry and the Military.

Our Government recognizes the "moral value" of communications in the home and is cognizant of the need for keeping receivers in working order. But—these are serious times and demands for military personnel must have priority.

It will be the basis and purpose of "Radio-TV Service Industry News" to constantly analyze the field and to offer some real practical help in meeting the many problems confronting all radio-television technicians.

We must preserve the radio-television service industry as long as it does not weaken our defense program. We need the full support of the broadcasters and telecasters. They stand to lose a dwindling audience if listeners and viewers do not get at least "minimum service" on their sets.

Technicians entering our industry from schools will require time to gain practical experience in the field before

they reach maximum production and learn the many peculiar problems of their own communities. Set production, in the meantime, continues at a record breaking pace in spite of shortages of parts, tubes, and manpower.

In an open letter to leaders in the television industry, Mr. A. M. Haas of Television Contractors Association states, "We think that the Government should give further consideration to an idea it has previously espoused because of the kind of war we may have today: dispersion of industry and the encouragement and support of secondary industrial reserves. Because of the vastness of our electronics program we believe the Government should think in terms of some television service shops becoming components in a 'National Industrial Reserve System.' It is obvious that our big industrial centers would be the first targets in an all-out war. If an enemy was successful in hitting some of our concentrated electronic industries we would have little to turn to for our electronic needs. But, if we prevented the disintegration of our television service shops, with their highly skilled technicians and their arrays of manufacturing and testing equipment, we might be able to utilize this resource."

We feel such a plan is feasible and workable. This could be at least a partial solution to one problem.

Other problems appear daily and there are many more to come. The participation by RADIO & TELEVISION NEWS in the Lecture Bureau activities will, we feel, be of great value to all technicians in solving these many present and future problems.

This will be your department and we need your comments and suggestions. We will have many problems analyzed by our panel of experts right in the field of radio and television servicing.

Send in your problems now for inclusion in the Department. They will be studied and passed on to the TTLB for comment and suggestion. Specially prepared feature articles will also result from our participation in this program. They'll be constructive and thought provoking—all written with one thought in mind—to add to the stature of radio-television servicing.

..... O.R.

NOW! get your new
ALLIED 1951 catalog!

FREE

212 Value-Packed Pages

**THE ONLY COMPLETE CATALOG FOR
EVERYTHING IN RADIO, TELEVISION
AND INDUSTRIAL ELECTRONICS**

Send For It Today!



HERE'S the only *complete* Buying Guide to TV, Radio and Industrial Electronics —packed with the world's largest selections of quality equipment at lowest, money-saving prices. See the latest in TV, AM and FM receivers; radio-phonos; new Sound Systems and P.A. equipment; high-fidelity custom sound components; recorders and accessories; full selections of newest Amateur receivers and station gear; test instruments; builders' kits; huge listings of parts, tubes, tools, books—*everything in stock* for immediate shipment.

ALLIED gives you *every* buying advantage: speedy delivery, expert personal help, lowest prices, assured satisfaction, liberal time payment terms. Get the new 1951 ALLIED Catalog. Keep it handy—it will save you time and money. Send today for your **FREE** copy!

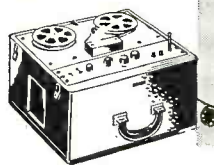
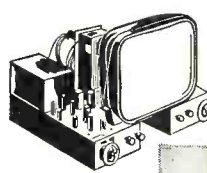
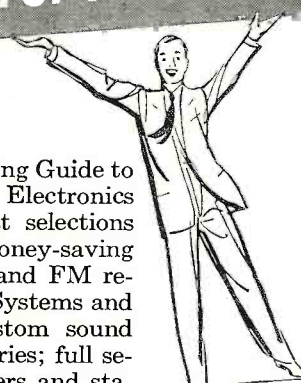

WORLD'S LARGEST STOCKS

- Radio Parts Unlimited
- Test Instruments—All Makes
- Television & Home Radios
- P.A. and Hi-Fi Equipment
- Amateur Station Gear
- Supplies for Industry

QUICK, EXPERT SERVICE



ALLIED IS YOUR TELEVISION HEADQUARTERS



To keep up with TV, depend on ALLIED! Count on us for the latest releases and largest stocks of picture tubes, component parts, antennas and accessories—plus the latest in TV tuners and kits. If it's *anything* in TV—we have it *in stock!* So remember—for TV—it's ALLIED First!



ALLIED RADIO

THE WORLD'S LARGEST RADIO SUPPLY HOUSE

Everything in Electronics

WRITE TODAY FOR RADIO'S
LEADING BUYING GUIDE

ALLIED RADIO CORP.
833 W. Jackson Blvd., Dept. 1-L-0
Chicago 7, Illinois

Send FREE 212-page 1951 ALLIED Catalog.

Name.....

Address.....

City.....Zone.....State.....

FREE





HOW TO REDUCE TV INTERFERENCE

Use Wave Traps Made With **OHMITE** "Frequency-Rated" **CHOKES**

There are many cases where the front end of a TV receiver lacks the selectivity required to eliminate very strong 14 or 28 Mc signals. These fundamental frequencies jam through the receiver front end and create many kinds of cross-modulation products which affect the viewed picture (not to mention the set-owner's temper). The only solution: each receiver affected must be treated separately, to prevent such fundamental frequencies from getting in and affecting the TV signal.

Tuned wave traps—either series, parallel, or combination types—are most commonly used to eliminate this trouble. They can be made effectively with Ohmite high-Q Chokes, in combination with suitable trimmer capacitors. (See diagrams at the right.)

Since most receivers have 300-ohm input, that type has been treated here. These designs, however, can be adapted to 72-ohm input as well. Series-tuned traps are connected from the receiver terminals to ground. In some cases, however, two parallel-tuned traps may prove equally satisfactory. The chokes and trimmers can be mounted on a small terminal board with binding posts or clips for easy installation.

WRITE FOR BULLETIN 133
AND CATALOGUE 21

OHMITE MANUFACTURING COMPANY
4884 W. Flournoy St., Chicago 44, Ill.

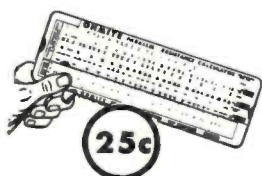

NEW OHM'S LAW CALCULATOR

Quickly solves all Ohm's Law problems—including parallel resistance. Also has standard slide rule.

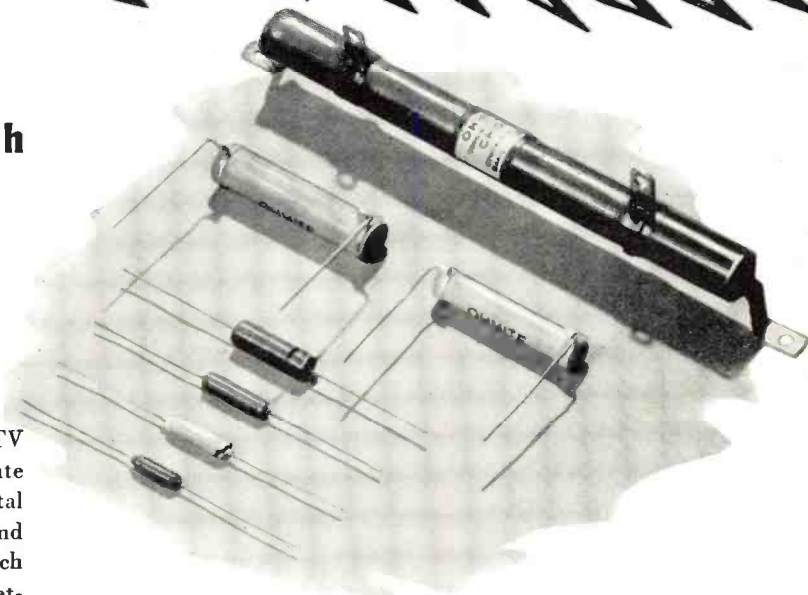

OHMITE CHOKES have accurately predetermined frequency characteristics. High "Q" single-layer wound on low power-factor plastic or steatite cores; insulated and protected by moisture-proof coating. Z-14 and Z-28 rated 600 ma; others 1000 ma. Seven sizes—covering range 3 to 520 megacycles.

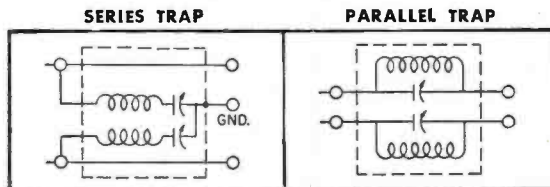

Table below shows approximate capacity necessary to resonate OHMITE Frequency-Rated Chokes at various frequencies:

OHMITE CHOKE	mmf at 3.5 Mc	mmf at 7 Mc	mmf at 14 Mc	mmf at 21 Mc	mmf at 28 Mc	mmf at 50 Mc	mmf at 56 Mc
Z-28	98	25	6.2				
Z-50		74	19	8.2	4.6		
Z-144			72	32	18	5.7	4.5
Z-235				6.9	39	12	9.7
Z-460						51	40

Be Right with **OHMITE**
Reg. U.S. Pat. Off.

RHEOSTATS • RESISTORS • TAP SWITCHES

GET INTO

RADIO-TELEVISION ELECTRONICS By

Shop-Method Home Training

GOOD JOBS AWAIT THE TRAINED RADIO-TV TECHNICIAN

There is a place for *you* in the great Radio-Television-Electronics industry when you are trained as National Schools will train you at home!

Trained technicians are in growing demand at good pay—in manufacturing, broadcasting, television, communications, radar, research laboratories, home Radio-TV service, and other branches of the field. National Schools Master Shop-Method Home Training, with newly added lessons and equipment, trains you in your spare time, right in your own home, for these fascinating opportunities. **OUR METHOD IS PROVED BY THE SUCCESS OF NATIONAL SCHOOLS TRAINED MEN, ALL OVER THE WORLD, SINCE 1905.**

EARN WHILE YOU LEARN

Many National students pay for all or part of their training with spare time earnings. We'll show you how you can do the same! Early in your training, you receive "Spare-time Work" Lessons which will enable you to earn extra money servicing neighbors' and friends' Radio and Television receivers, appliances, etc.

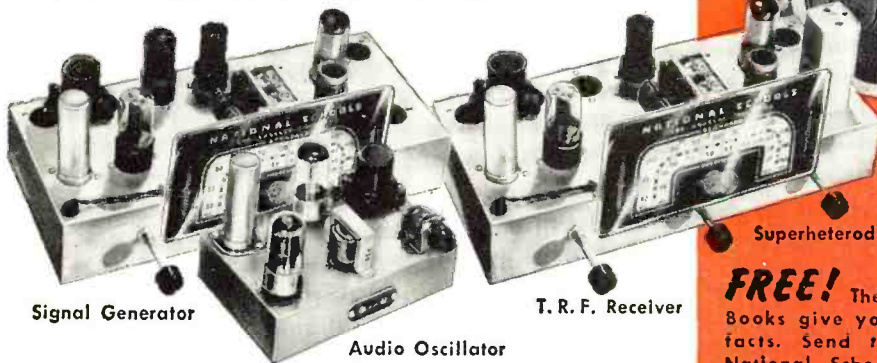

Signal Generator

Audio Oscillator

T. R. F. Receiver

National Schools Training Is All-Embracing

National Schools prepares you for your choice of many job opportunities. Thousands of home, portable, and auto radios are being sold daily—more than ever before. Television is sweeping the country, too. Co-axial cables now under construction will soon bring Television to every city, town, and farm! National Schools' complete training program qualifies you in all fields. Read this partial list of opportunities for trained technicians:

- Business of Your Own • Broadcasting
- Radio Manufacturing, Sales, Service • Telecasting
- Television Manufacturing, Sales, Service
- Laboratories: Installation, Maintenance of Electronic Equipment
- Electrolysis, Call Systems
- Garages: Auto Radio Sales, Service
- Sound Systems and Telephone Companies, Engineering Firms
- Theatre Sound Systems, Police Radio
- And scores of other good jobs in many related fields.

TELEVISION TRAINING

A complete series of up-to-the-minute Television lessons is an important part of your course. They cover all phases of Television repairing, servicing and construction. The same lesson texts used by resident students in our own modern and complete Television broadcast studios, laboratories and classrooms!



MASTER ALL PHASES!



Get Master Shop-Method Home Training from an Established Practical Resident School with its own Training Shops, Laboratories, and Studios—and almost 50 Years of Successful Experience in Training Ambitious Men.

We Bring National Schools To You



You also receive this Multitester

LEARN BY DOING

You receive and keep all the modern equipment shown above, including tubes and valuable, professional quality Multitester. *No extra charges.* You build the fine Superheterodyne Receiver with parts we send you.

FREE!

These 2 Free Books give you all the facts. Send today for National Schools' new, Illustrated Book of Opportunity in Radio-Television-

Electronics, and an actual Sample Lesson. No cost—no obligation. Use the coupon now—we'll answer by return airmail.

APPROVED FOR VETERANS AND NON-VETERANS
Check coupon below

Both Resident & Home Study Courses offered



NATIONAL SCHOOLS

LOS ANGELES 37, CALIF. • EST. 1905

FIND OUT NOW... MAIL COUPON TODAY

National Schools, Dept. RN-11
4000 South Figueroa Street
Los Angeles 37, California

Mail in envelope or paste on penny postal.

Send me your FREE book "Your Future in Radio" and the sample lesson of your course. I understand no salesman will call on me.

NAME _____ AGE _____
ADDRESS _____
CITY _____ ZONE _____ STATE _____

Check here if Veteran of World War II

Brush has it!

MIKES AND PHONES THAT ARE "CRYSTAL CLEAR"

HAND OR DESK MICROPHONE

(BA-116)



Rugged dependability and uniform frequency response. Unbeaten in its price range for PA, home, institutional and industrial use. Use in hand or on desk without need of stand. But also equipped for use with standard $\frac{5}{8}$ " 27 thread stand. Brown metallic finish, 8' cable. List, \$14.75.

"VIBROMIKE" (VM-1)

Miniature contact-type microphone with unusually wide frequency response. $\frac{7}{8}$ " x $\frac{3}{4}$ " x $\frac{5}{8}$ ". Output volume from .05 to .1 volt or higher. Complete with mounting clamp and 25' cable. List, \$19.50.



NEW MICROPHONE (BA-109) FOR PA, HOME AND AMATEUR

A beautiful new microphone for applications that require natural reproduction of both music and voices. Uses an advanced development of the "Acoustical" cartridge pioneered by Brush. Pickup pattern non-directional in the horizontal plane. Essentially flat frequency response from 40 to 10,000 cps. Designed for use with $\frac{5}{8}$ " 27 thread stand. Finished in maroon plastic and brushed chromium List, \$22.50.

GENERAL PURPOSE MICROPHONE (BA-106)



Using the exclusive "Acoustical" cartridge. Vibration, shock, low frequency wind noise or humidity do not affect the high fidelity. Excellent for general use. Output level Minus 50 db. below 1 volt/bar List, \$19.75.

LAPEL MIKE (BL-2)

Virtually flat response. Small and rugged. Can be used as hand or instrument mike, as well as lapel. $1\frac{1}{2}$ " x $2\frac{1}{4}$ ". Complete with 25' cable. List \$25.00.

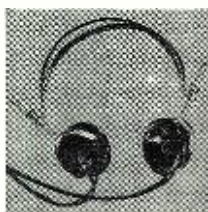

High fidelity Model "A-1", \$18.00



Model "A" general purpose, \$12.00



Model "A" single phone, \$6.45

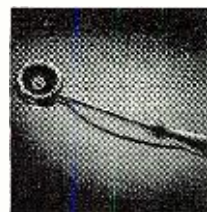

Model "A" lorgnette phone, \$9.75



"BA-303" Hushatone \$9.75

You can get it!

Brush products are distributed all over U. S. A. If your own radio parts jobber does not have it, write to us and we will send you name of nearest jobber.

THE BRUSH DEVELOPMENT COMPANY
3405 Perkins Avenue • Cleveland 14, Ohio

FOLLOW THE LEADERS

BUY WISE...

BUY THE ORIGINALS...

BUY **HYTRON** TV FIRSTS

Westinghouse

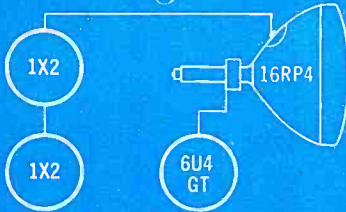

Admiral

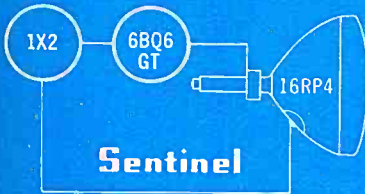
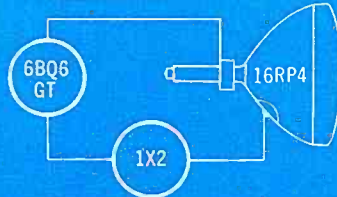

Sentinel

OLYMPIC

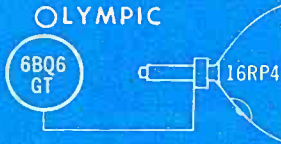

BENDIX



CROSLY

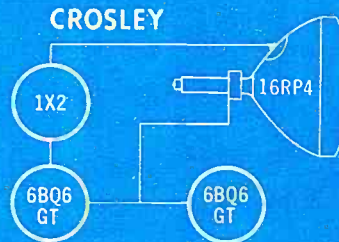

TRAV-LER

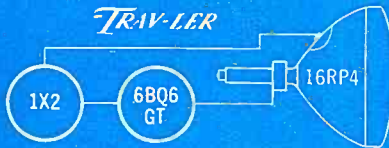

PHILCO

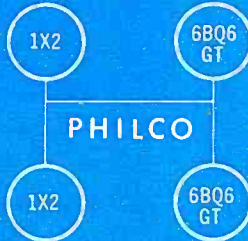

STROMBERG-CARLSON

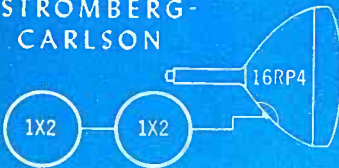

hallicrafters



Packard-Bell

6U4 GT

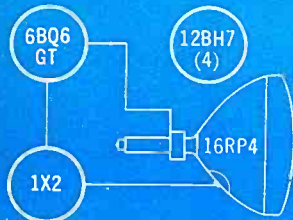

air-king

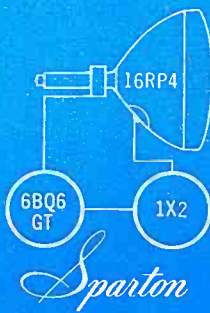

Spartan

Hoffman



National

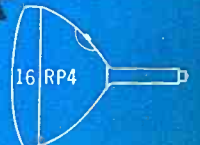

Motorola

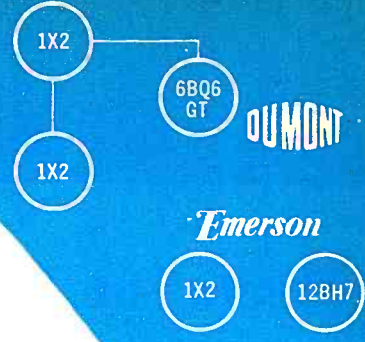

Magnavox

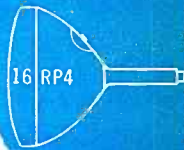

Ask for the original Hytron TV firsts: Hytron 1X2 compact, high-voltage TV rectifier. Hytron 6BQ6GT, 25BQ6GT extra-performance deflection amplifiers. Hytron 6U4GT high-perveance damping diode. Hytron 12BH7 twin-triode sweep amplifier with superior efficiency. Hytron 16RP4 original rectangular TV picture tube.



MAIN OFFICE: SALEM, MASSACHUSETTS

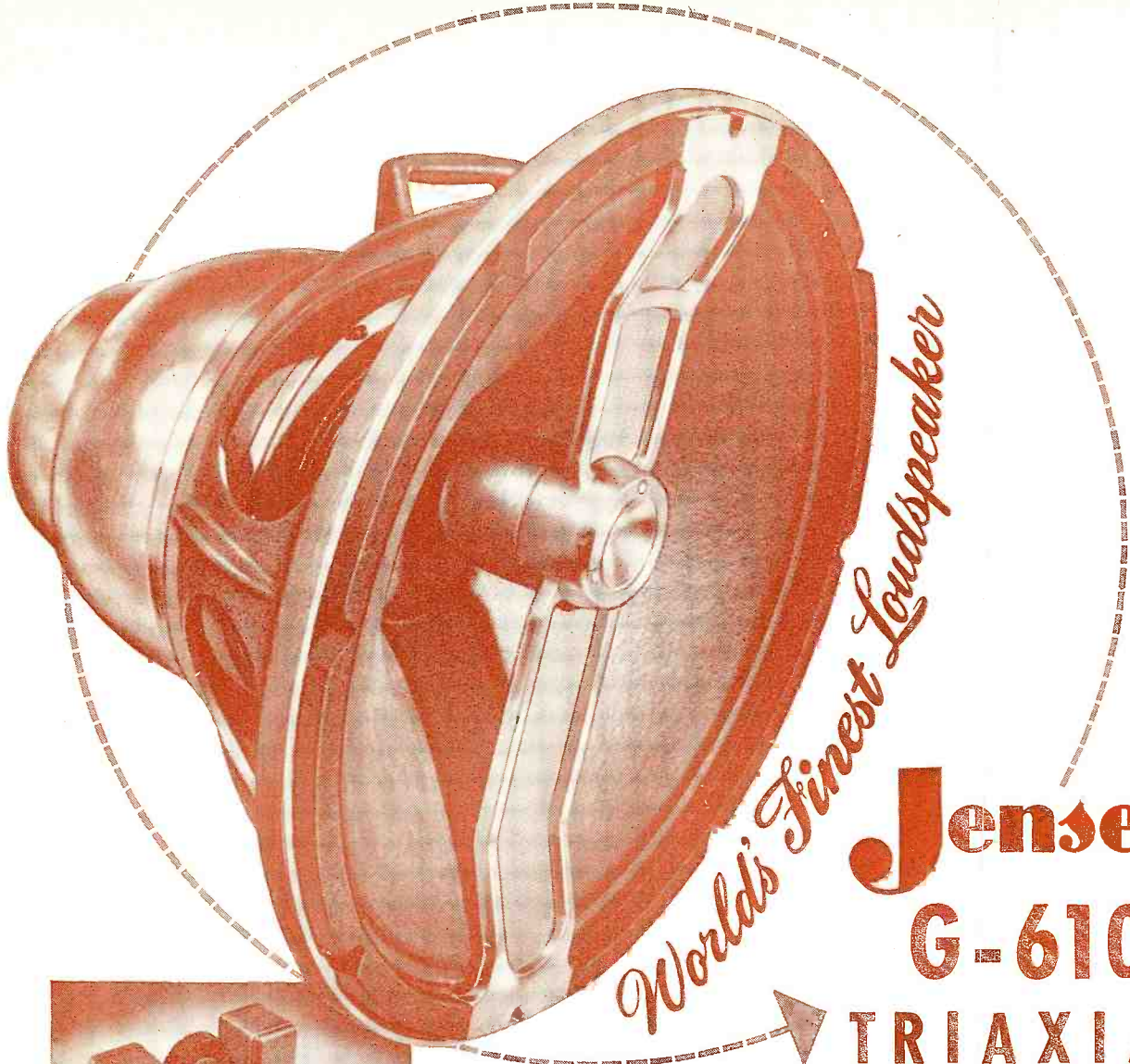

World's Finest Loudspeaker

Jensen

G-610

TRIAxIAL

LOUDSPEAKER SYSTEM

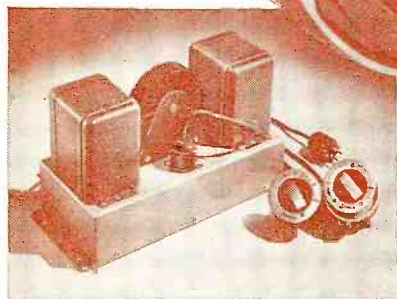

Never Before Reproduction Like This!

The G-610 brings a totally new meaning to high fidelity sound reproduction. Not only does this new 3-channel system reproduce the widest frequency range ever attained by a loudspeaker, but it also sets new high standards with its incomparably smooth response characteristic and very low distortion. The result is clear, clean, life-like quality, with thrilling *transport to the original* such as you have never heard before. The G-610, complete with Speaker Unit and Crossover and Control network is priced at \$365.00 list. Ask for Data Sheet 160.

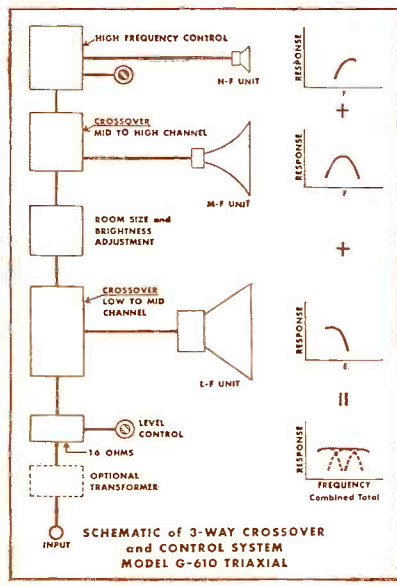

Jensen

Manufacturing Company

Division of the Muter Company

6617 SOUTH LARAMIE AVENUE, CHICAGO 38, ILLINOIS

More light on the
radio tube situation . . .

AN OPEN LETTER TO RADIO SERVICE DEALERS

SYLVANIA

ELECTRIC PRODUCTS INC.

EMPORIUM • PENNSYLVANIA

First of all, we want to thank all of you good service dealer friends for your loyalty and cooperation.

Here are the FACTS: Even before the Korean trouble, the increasing demand for Sylvania Tubes was keeping our factories on round-the-clock production schedules. With the meteoric growth of television, still greater production facilities were needed.

Since the Korean war a flurry of buying by industrial customers and the service industry alike soon reduced warehouse and factory stocks to an all-time low.

Here's how Sylvania protects you now: To make certain that all of its regular service dealer customers are protected in this period of limited supply, Sylvania has effected a three-fold program of protection.

1. Production facilities have been greatly increased. Two additional plants have already been placed in operation. Another is under construction.
2. Your Sylvania radio and television tube suppliers are now being taken care of on an allocation plan, which we feel is established on the fairest possible basis.
3. Sylvania will continue to supply you with complete technical information for your service work, including latest data on substitution of available types for critical types.

Sylvania realizes that in the months ahead the whole country will depend upon you service dealers to keep its radios, TV sets and communications equipment in top working order. Your Sylvania Distributor will not have all the tubes you want but will do his best to serve you. We feel a deep obligation to give you the greatest possible aid in doing this job, but naturally, our country's defense needs come first.

As we have demonstrated in the past, Sylvania is ever mindful of the importance of its Service Dealers and servicemen to the nation and to the industry. We will continue to do everything possible to preserve the fine relationship existing between Sylvania, its distributors, and you, its loyal dealer customers.

Cordially yours,
SYLVANIA ELECTRIC PRODUCTS INC.
H. H. Rainier
Manager, Distributor Sales

INCANDESCENT LAMPS • RADIO TUBES • FLUORESCENT LAMPS AND FIXTURES • ELECTRONIC DEVICES

PREMIUM QUALITY AT NO EXTRA COST

Sprague Black Beauty Telecap* Tubulars are different from and superior to every other molded paper capacitor because they are made by the same dry assembly process as large metal-encased oil capacitors. They cannot be contaminated by dust or moisture during manufacture.

Ask for Black Beauty Telecaps at your jobber's.

*Trade Mark

Non-flammable,
dense bakelite
phenolic-molded
housing

Hollow eyelet terminal
for oil im-
pregnation after
molding

Uniform wind-
ings of high
purity paper
and alumi-
num foil



CUT AWAY VIEW

Solder seal as in
large metal-encased
oil capacitors

SPRAGUE

SPRAGUE PRODUCTS COMPANY

(Distributors' Division of Sprague Electric Co.)

51 Marshall Street
NORTH ADAMS, MASS.

Spot Radio News

★ Presenting latest information on the Radio Industry.

By RADIO & TELEVISION NEWS'
WASHINGTON EDITOR

THE RED, GREEN AND BLUE TV fracas, which has been quite a blazing affair for nearly ten years and destined to continue *ad infinitum*, came to a screeching halt as the summer ended when the august body of seven electronic jurists of Washington finally unfurled a plan to end, at least temporarily, the color-fest. The plan, to the dismay of many, and the delight of some, routed the prize cup into the halls of CBS for a tenure which may end early next year, or be labeled permanent for many years. The award can bounce back to Princeton or San Francisco, if RCA or CTI can show that their systems can do a better job, these proponents having until to December 5 to produce the equipment that will or will not sparkle, and until January 5 to process a report outlining their improvements. In the meantime, the CBS field-sequential method has become the white-haired idol and industry will have to provide the means to receive the 405-line pictures in black and white. Actually the FCC *told* industry that they *must* provide chassis with a manual or automatic switch which will provide instantaneous selection of the standard 525 or color's 405 lines, or there'll be no further consideration of other possible tri-hued ideas and the CBS plan will become the basis of official color standards.

The cold, blunt edict to the manufacturers was issued, according to the FCC, because they felt that they . . . "cannot postpone a color decision since each day that passes would aggravate the compatibility problem." In their opinion, if a decision were to be made now, the CBS system would be adopted, but if a procedure can be devised whereby the compatibility problem would not be intensified, they would be willing to look further into the consideration of four basic matters: (1) The utilization of direct-view tubes larger than the 12½ inches used in the CBS system; (2) the use of horizontal interlace; (3) the use of long-persistence phosphors; and (4) the development of new compatible systems or improvements in compatible systems which have been informally called to the Commission's attention since the hearing record was closed.

THE CONCLUSIONS REACHED
by the Commission cited that the CBS

system looked best to them, because it complied with more of the requirements set forth in the seven-point system criteria issued before the hearings began. In their list of performance virtues which a system had to meet before it could be considered eligible for adoption, the Commission pointed out that the system . . . "must be capable of operating within a 6-megacycle channel allocation structure, and must be capable of producing a color picture which has a high quality of color fidelity, adequate apparent definition, good picture texture and is not marred by such defects as misregistration, line crawl, jitter, or unduly prominent dot or other structure." The FCC also asked that the . . . "color picture be sufficiently bright so as to permit an adequate contrast range and be capable of being viewed under normal home conditions without objectionable flicker." In addition, the governmental body asked that the system be . . . "capable of operating through receiver apparatus that is simple in the home, does not have critical registration or color controls, and is cheap enough in price to be available to the great mass of the American purchasing public" . . . and . . . "be capable of operating through apparatus at the station that is technically within the competence of the type of trained personnel hired by the station owner who does not have an extensive research or engineering staff at his disposal, and the costs of purchase, operation, and maintenance of such equipment must not be so high as to unduly restrict the class of persons who can afford to operate a television station." The concluding requirements stated that the system . . . "must not be unduly susceptible to interference as compared with the present monochrome system, and must be capable of transmitting color programs over intercity relay facilities presently in existence or which may be developed in the foreseeable future."

Reviewing these criteria, the Commission pointed out that compatibility, the term over which the experts wrangled for weeks and weeks, was not even mentioned. Qualifying this omission, the Federal specialists declared that if a . . . "satisfactory compatible system were available, it would certainly be desirable to adopt

RADIO & TELEVISION NEWS

Over 50,000 SERVICEMEN must be right!

NEW... **EICO** Instruments and **KITS** give you Laboratory Precision at Lowest Cost!

VACUUM TUBE VOLTMETER

Versatile top-quality laboratory-precision VTVM for trigger-fast operation and lifetime dependable service.

15 different ranges. Large rugged 4½" meter, can't-burn-out circuit. New zero center for TV & FM discriminator alignment. Electronic AC & DC ranges 0-5, 10, 100, 500, 1000 v. (30,000 volts and 200 MC with HVP-1 and P-75 probes). Ohmmeter ranges, .2 ohms to 1000 megs. DB scale. New stable double-triode balanced bridge circuit—extreme accuracy. 26 megs DC input impedance. Attractive 3-color etched rubproof panel; rugged steel case. 115 v., 60 cycle AC. 9-7/12 x 6 x 5".

Model 221-K, KIT, only \$23.95
Model 221, factory wired, \$49.95



New TUBE-TESTER

The brand new professional tube tester and merchandiser EICO Service-Engineered for unbeatable value!

Large 4½" full-vision meter. Tests conventional and TV tubes including 9-pin miniatures. New lever-action switches—tests every tube element. Illuminated "Speedroll Chart." 2 grid caps. Short and open-element tests. Spare socket for new tubes. Protective overload bulb. Electronic rectifier. Handsome 3-color etched rubproof panel; rugged steel case. 115 v., 60 cycle AC. 12½ x 9½ x 4½".

Model 625-K, KIT, only \$29.95
Model 625, factory wired, \$44.95



5" PUSH-PULL OSCILLOSCOPE

All-new laboratory-precision scope gives you all the extra sensitivity and response for precise servicing of TV, FM & AM receivers.

Push-pull undistorted vertical and horizontal amplifiers. Boosted sensitivity, .05 to .1 rms volts/inch. Useful to 2.5 MC. TV-type multivibrator sweep circuits, 15 cps—75 KC. Z-axis intensity modulation feature. Dual positioning controls move trace anywhere on screen. Complete with 2-6J5, 3-6SN7, 2-5Y3, 58P1 CRT. Handsome 3-color etched rubproof panel; rugged steel case. 115 v., 60 cycle AC. 8½ x 17 x 13".

Model 425-K, KIT, only \$39.95
Model 425, factory wired, \$69.95



RF PROBE

Sensitive Germanium crystal probe for signal tracing and measurements to over 200 MC. Extends range of VTVMs and scopes.

Model P-75K KIT, for VTVM;
P-76K for Scope; ea. \$3.75
Model P-75 or P-76,
factory wired, ea. \$7.50



HIGH VOLTAGE PROBE

A new professional EICO-engineered MV-probe carefully designed and insulated for extra safety and versatility. Extends range of VTVMs and voltmeters up to 30,000 volts. Lucite head. Large flashguards. Multi-layer processed handle. Complete with interchangeable ceramic Multiplier to match your instrument.

Model HVP-1, only \$6.95



New Deluxe Kit AM-FM-TV SIGNAL GENERATOR

A laboratory-precision generator EICO Service-Engineered with 1% accuracy.

Extremely stable, frequency 75 KC—150 MC in 7 calibrated ranges. Illuminated hairline vernier tuning. VR stabilized line supply. 400-cycle pure sine wave with less than 5% distortion. Tube complement: 6X5, 7F7, 6C4, VR-150. Handsome 3-color etched rubproof panel; rugged steel case. 115 v., 60 cycle AC. 12 x 13 x 7".

Model 315-K, KIT, only \$39.95
Model 315, factory wired, \$59.95

New BATTERY ELIMINATOR & CHARGER

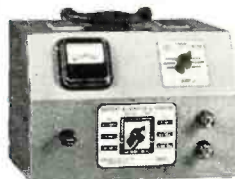

Model 1040-K, KIT, only \$22.95
Model 1040, factory wired, \$29.95

The brand new 6-volt power supply EICO Service-Engineered for extra reserve electrical power for all auto radio testing.

Latest-type full wave bridge circuit, extra-heavy-duty 4 stack manganese copper-oxide rectifiers. Latest Variac-type transformer: 0-15 volts output. Continuous operation: 5-8 v., 10 amps; intermittent: 20 amps; 10,000 mfd filter condenser. Rugged meter measures current and voltage output. Double protection: fused primary; automatic reset overload device for secondary. Handsome rugged hammer-tone steel cabinet. 115 v., 60 cycle AC. 10½ x 7½ x 8¾"

Easy-to-follow step-by-step EICO pictorial & schematic instructions—most explicit & comprehensive in electronics!—supplied with each Kit. Anyone can build the EICO Kits!

the exclusive EICO Make-Good GUARANTEE

Each EICO Kit and Instrument is doubly guaranteed, by EICO and your jobber to contain only selected quality components. EICO guarantees to replace any component which might become defective in normal use if returned to the factory within 90 days of purchase. EICO guarantees all Kits assembled according to EICO's simplified instructions will operate as specified therein. EICO guarantees service and calibration of every EICO Kit and Instrument at the nominal charge as stated in the instructions.

See these other EICO Instrument KITS:

Model 320-K Sig Gen KIT, \$19.95
Model 360-K Sweep Gen KIT, \$29.95
Model 145-K Sig Tracer KIT, \$18.95
Model 511-K VOM KIT, \$14.95

Due to unsettled conditions, all prices are subject to change without notice.

Be sure to look at the EICO line before you buy any higher-priced equipment! From etched rubproof panel to modern engineering design, each EICO Kit and Instrument is 'crum-packed' with unbelievable value to satisfy the most exacting engineering requirements. YOU be the judge—compare EICO at your local jobber today, and SAVE! Write NOW for free latest Catalog R describing the complete EICO line.

Prices 5% higher on West Coast

**ELECTRONIC INSTRUMENT
COMPANY, INC.**

276 Newport St., Brooklyn 12, N. Y.

© 1950, Electronic Instrument Co., Inc., Brooklyn, N. Y.

There's a *University* Loudspeaker

RUGGED!

DEPENDABLE!

VERSATILE!

FOR EVERY COMMERCIAL AND INDUSTRIAL APPLICATION



TRUMPETS Model 7102 exemplifies the rugged construction and progressive engineering behind every University product. Model 7102 is the only loudspeaker ever approved by Underwriters' Labs for Class II Groups E, F, & G hazardous area duty. Features include re-entrant trumpet (pioneered by University) for compactness and greater efficiency, heavy duty 25 watt driver unit with exclusive University "W" shaped Alnico V magnet, and built-in line matching transformer with impedances of 16, 45, 500, 1000, 1500, and 2000 ohms. See general catalog for trumpets of all sizes.



BREAKDOWN-PROOF DRIVER UNITS Model PA-30 embodies features developed by University and never successfully imitated. Ratings are conservative, and construction is to well known University standards which have made our drivers famous for their dependable performance. PA-30 is rated at 30 watts, with response 80-10,000 cps, and is the first to have a multi-tap built-in line matching transformer. Exclusive "rim centering" construction of mechanism and use of University "W" shaped Alnico V magnet insures high conversion efficiency, permanent voice coil alignment regardless of shock or vibrations. Weatherproofed throughout.

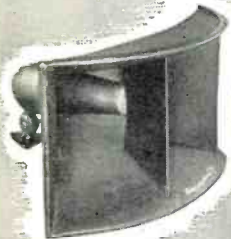

PAGING AND INTERCOM SPEAKERS These feature reflex air columns with hermetically sealed driver units. They are widely used for intercommunication and paging of all types. Efficiency is high and reproduction exceptional at any volume level. Directional, radial, or bi-directional types available. Weather-proof finishes permit use anywhere. Typical of University pace-setting design is the Cobra-12 illustrated, which provides optimum area coverage with minimum power input. Power rating is 12 watts, frequency response 250-10,000 cps, dispersion angle 60° x 120°. Swivel mounting bracket provides full flexibility.



SUBMERGENCE-PROOF SPEAKERS These types are designed for use where extreme ruggedness and immunity to spray, gases, live steam or dust are essential. Function even under water, drain automatically, operate continuously regardless of exposure. Models available for directional or radial projection, wall or bulkhead mounting, swivel mount and with or without built-in line matching transformer and attenuator. Design is ideal for railroad use, shipboard, industries, docks, rough mobile work, etc. Model MM-2, illustrated, is rated at 15 watts continuous IPM, frequency 300-6000 cps, impedance 16 ohms.

FOR ALL HIGH FIDELITY REPRODUCTION REQUIREMENTS

WIDE RANGE CONE SPEAKERS Model 6201 comprises a superb 12" cone speaker with a driver type tweeter mounted coaxially. The cone speaker features a 24 oz. "W" shaped Alnico magnet and edge treated cone for distortion-free low frequency response. Tweeter has wide angle horn. A built-in LC crossover network and external high frequency attenuator are included. Capacity is 25 watts, I.P.M., response 45-15,000 cps, impedance 8 ohms. Other cone speakers for high fidelity, splashproof or blastproof service also available.

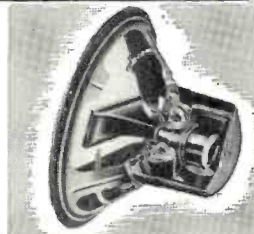

HI-FREQUENCY TWEETERS University offers a complete line of single and double tweeter units for both 2000 and 600 cycle crossover. Models are available for medium or extremely wide sound distribution. A complete line of accessories are included—crossover networks, adapter for mounting tweeter on a standard cone speaker, etc. These tweeters may be added to any standard amplifier and speaker to provide the finest in high fidelity reproduction—and at a very low cost.

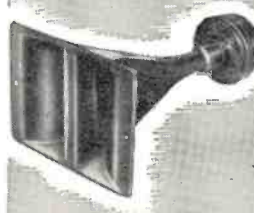

WRITE DEPT. A TODAY FOR YOUR FREE COPY OF THE NEW 24-PAGE UNIVERSITY TECHNIQUE — A COMBINED TECHNICAL MANUAL AND CATALOG — INVALUABLE FOR YOUR FILES.



University LOUDSPEAKERS
INCORPORATED

80 SOUTH KENSICO AVE., WHITE PLAINS, NEW YORK

such a system. Compatibility would facilitate, for the broadcaster, the transition from black and white broadcasting to color broadcasting and would reduce to a minimum the obsolescence problem of present receivers. However . . . no satisfactory compatible system was demonstrated in these proceedings." The Commission then added that, in their opinion . . . "based upon a study of the history of color development over the past ten years, from a technical point of view, compatibility, as represented by all the color television systems which have been demonstrated to date, is too high a price to put on color. . . . The receiver aspect of compatibility, moreover, is merely a temporary problem which will decrease progressively each year, once receivers are built incorporating new standards. Based on the assumption of seven million sets in the hands of the public at the present time, the problem of compatibility would be diluted each year depending on the annual rate of production."

ONE PERSON in Washington particularly happy about the decision, was Senator Edwin Johnson, who has been campaigning for a definite answer on color. Said the Senator, in a letter to FCC Headman Wayne Coy, . . . "The decision brings very close the day when this great new improvement . . . will serve the American people. . . . Leaving the door partly ajar, affording an opportunity to the Johnny-come-latelys, is a challenge to them to produce or step aside. Moreover, it is in the best traditions of American democracy and the free enterprise system, since it does not foreclose improvements, which I am sure our American electronic science may bring out. . . . I know that every effort will be made to push forward rapidly the allocation decisions so that television will be made available to many more millions of citizens who are waiting impatiently to have television in their homes."

The opinions of the Commission appeared in a report, rather than a formal decision, which implied that further considerations of the important subject would be held. The report, a 48-page effort, covered practically every facet of the color issue. In a section on the superposition of color images, for instance, the registration, color breakup, and color fringing properties of the three systems were reviewed thoroughly. Detailing the registration characteristics of the CTI system, the report said: "There is a severe registration problem at the camera and receiver. At the camera end, the optical system must be so adjusted and maintained that the image being transmitted falls upon the three separate color bands of the tube in exactly the same relative position. . . . At the receiver end, the same precise adjustments must be made. . . . It is exceedingly diffi-

(Continued on page 112)



Train at Home in Spare Time for **RADIO** and **TELEVISION**

**I Send You
18 BIG
KITS
OF RADIO-
TELEVISION
EQUIPMENT**

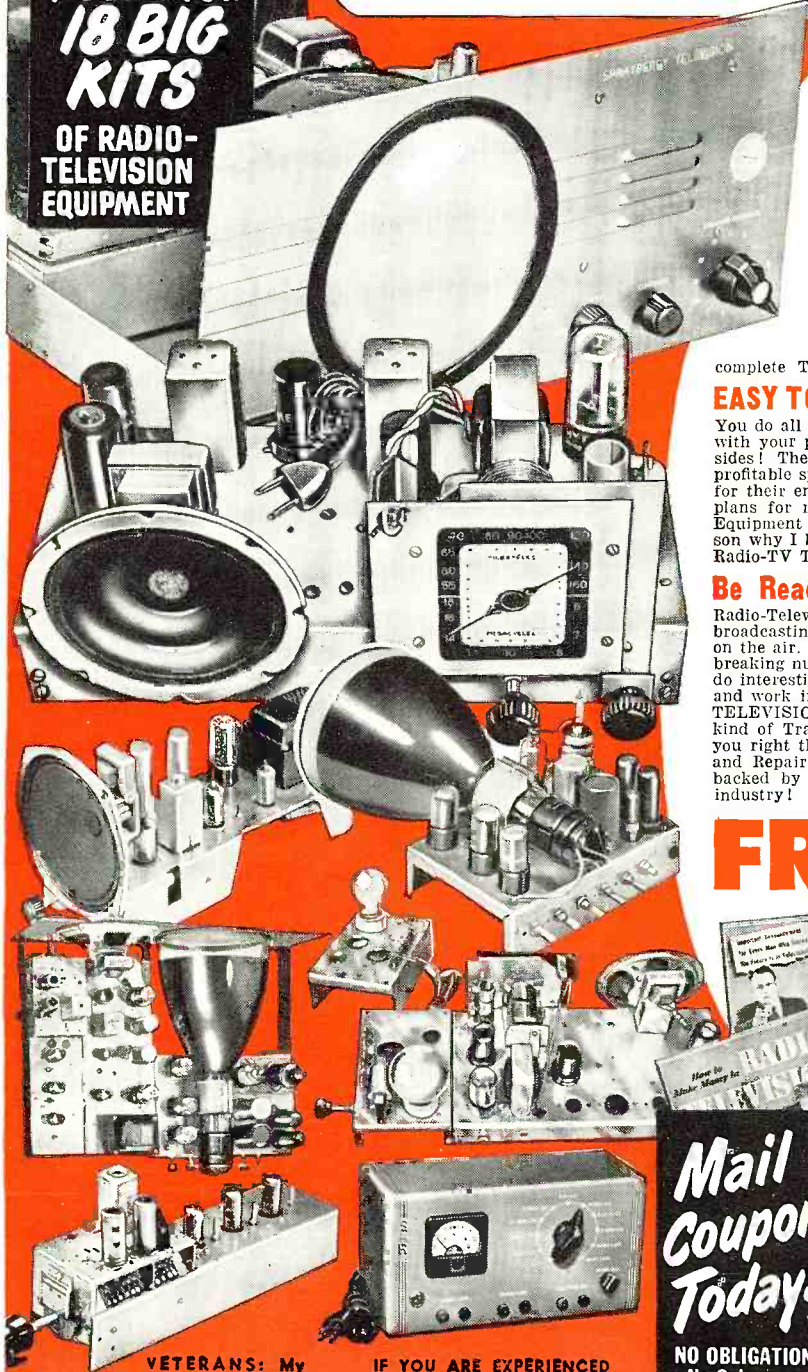

**My Famous Training System Prepares
You in Double-Quick Time for a Good
Job or Your Own Profitable Radio-
Television Business**

Radio-Television is now America's greatest opportunity field! Trained men are needed to fill good jobs and handle profitable Radio-Television Service work. I have trained hundreds of men for success in Radio-Television—and I stand ready to Train you too, even if you have no previous experience. My training is 100% practical—designed to give you the knowledge and experience you need to make money in Radio-Television in the shortest possible time. I Train you with up-to-the-second revised lessons—PLUS many big kits of Radio-Television equipment. You actually do over 300 demonstrations, experiments and construction projects. In addition, you build a powerful 6-tube 2-band radio, a multi-range test meter and a complete Television receiver! All equipment is YOURS TO KEEP.

EASY TO MAKE EXTRA MONEY WHILE YOU LEARN

You do all your training with me AT HOME in spare hours. Keep right on with your present job and income while learning—and earn extra cash besides! The day you enroll I begin sending you plans and ideas for doing profitable spare-time Radio-TV work. Many of my Sprayberry students pay for their entire training this way! You get priceless experience and many plans for making extra money. You build all your own Radio-TV Test Equipment from parts I send you—nothing else to buy. Just one more reason why I believe I offer the ambitious man the biggest value in top notch Radio-TV Training available anywhere in America today.

Be Ready for Top-Paying Radio-Television Jobs

Radio-Television is growing with amazing speed. More than 2000 Radio broadcasting stations PLUS an additional 102 Television stations are now on the air. Radio sets and TV receivers are being made and sold in record-breaking numbers. If you enjoy working with your hands . . . if you like to do interesting and varied work . . . if you really want to make good money and work in an industry that has a future . . . YOU BELONG IN RADIO-TELEVISION. But you MUST have good Training to "cash in" . . . the kind of Training that starts you out with basic fundamentals and carries you right through every circuit and problem of Radio-Television Servicing and Repair. In a word . . . that's Sprayberry Training . . . the course backed by more than 20 years of association with the Radio-Television industry!

**FREE 3 BIG RADIO-
TELEVISION BOOKS**

I want you to have ALL the facts about my complete system of Radio-Television Training! Act now! Rush the coupon for my three big Radio-Television books: "How to Make Money in Radio-Television," PLUS my new illustrated Television Bulletin PLUS an actual sample Sprayberry Lesson—all FREE with my compliments. No obligation and no salesman will call on you. Send the coupon in an envelope or paste on back of post card. I will rush all three books at once!

**Sprayberry Academy of Radio, Dept. 25-P
111 North Canal St. Chicago 6, Ill.**

**Mail
Coupon
Today!**
**NO OBLIGATION
No Salesman
Will Call**

**SPRAYBERRY ACADEMY OF RADIO, Dept. 25-P
111 North Canal St., Chicago 6, Ill.**

Please rush to me all information on your Radio-Television Training Plan. I understand this does not obligate me and that no salesman will call upon me.

Name..... Age.....

Address.....

City..... Zone..... State.....

Please Check Below About Your Experience

Are You Experienced? No Experience

**VETERANS: My
Radio Training is
Approved for Vet-
erans.**

**IF YOU ARE EXPERIENCED
in Radio I'll qualify you for
Television in 4 to 8 weeks.
Rush coupon.**

announcing **CENTRALAB'S**



GUIDE NUMBER 12

Centralab

TV CONTROL GUIDE
REPLACEMENT CONTROLS
FOR TELEVISION

NET PRICE 25 CENTS

REPLACEMENTS

ne

TV CONTROL GUIDE

Service engineers! Here's the industry's most complete reference for TV control service . . . Lists 1600 controls . . . for all popular models.

**A
TIME-SAVER
FOR YOU**

Centralab's new TV Control Guide lets you get *all controls you need from your Independent Parts Jobber. One source — one stop — for CENTRALAB QUICKEST FOR SERVICING CONTROLS.*

Yes! Centralab's new TV Control Guide is an absolute "must" for up-to-the-minute TV service engineers. It's a big time-saver when you can have one source for your special TV controls . . . controls that are ready to go — no time lost fumbling with assembly.

A BONUS FOR YOU — The new guide also contains the industry's *FIRST PRINTED ELECTRONIC CIRCUIT REPLACEMENT LISTING*. It shows you over 100 listings that can be serviced by only 11 standard Centralab printed circuit plates — all stock items.

Centralab

Division of GLOBE-UNION INC., Milwaukee

Order your copy now, only 25c

Order your copy of Centralab's new TV Control Guide now. If you act promptly, you'll not only get the guide and the Printed Circuit lists — we will include a *price list and a valuable special control bulletin on custom controls for older radio models*. Send 25 cents in stamps or coin together with the coupon below. You'll get your new TV Control Guide with all its other valuable features by return mail. Order now while the supply lasts.

**TEAR OUT . . .
MAIL AT ONCE 25c**

Centralab Division of Globe-Union Inc., 910 E. Keefe Ave., Milwaukee, Wis.

I enclose 25 cents for Centralab's new TV Control Guide together with the Printed Electronic Circuit listing. Also include price list and listing of custom controls for older radios.

Name.....

Address.....

City..... Zone..... State.....

Please!

I am a Service Engineer Ham Jobber Tv Set-Owner.



ASSURES YOU the most complete tests of all tubes including television.

ACTUALLY APPLIES 19 separate filament voltages—eliminates usual compromises.

TESTS OVER 700 tubes listed on roll chart—Many thousand tubes used to properly evaluate correct settings.

POSITIVE INDIVIDUAL test of each element.

SPECIAL CIRCUIT feature accurately compensates to provide correct voltages on each tube test.

IMPROVED LEVER switching originated by Triplet for complete control of each tube element.

EACH ELEMENT quickly and conclusively tested for shorts by a flip of the switch.

ILLUMINATED SPEED-ROLL chart with latest tube listings. Kept up-to-date.

LARGE 6" meter—RED-DOT Life-time Guaranteed.

FOR COUNTER or portable use.



In Canada: Triplet Instruments of Canada, Georgetown, Ontario

FOR THE MAN WHO TAKES PRIDE IN HIS WORK

Triplet

TRIPLET ELECTRICAL INSTRUMENT COMPANY • BLUFFTON, OHIO, U.S.A.

REPLACEMENT OR REFUND OF MONEY
 ★
 Guaranteed by
 Good Housekeeping
 IF NOT AS ADVERTISED THEREIN

GRANTED TO...

RAYTHEON TELEVISION

ANOTHER PROOF OF RAYTHEON DEPENDABILITY!



THE MARQUIS
 Model C-1714

As Advertised in *Life*, *Good Housekeeping*,
Saturday Evening Post

BELMONT RADIO CORPORATION
 5921 W. Dickens Avenue, Chicago 39, Ill.
 Subsidiary of RAYTHEON MFG. CO.

You know how important that GOOD HOUSEKEEPING guaranty seal is... what thorough testing a product must go through before it is guaranteed as advertised in GOOD HOUSEKEEPING. Now—that famous seal is granted to the entire line of RAYTHEON television sets!

It's another proof of the dependability of Raytheon. And no wonder! Every Raytheon set is precision engineered... made of top-quality parts and materials... to give outstanding performance. Raytheon uses no short cuts—leaves out no parts—in order to cut prices. All reasons why you can place full confidence in Raytheon!

See the beautiful new models now available in the 1951 Raytheon line. Every one is dependably built for dependable performance!

List Prices Range from \$189.95 to \$625.00

Here's Plus Proof That Every Raytheon Set Is...



Backed by a liberal
 One-year Warranty!



Backed by the Under-
 writers' Laboratories Seal!



Made by a leader in
 electronics for 25
 years!

Dependably Built for Dependable Performance

the New
PYRAMID
"Humidi-Seal"

(TUBULAR PAPER CAPACITOR)

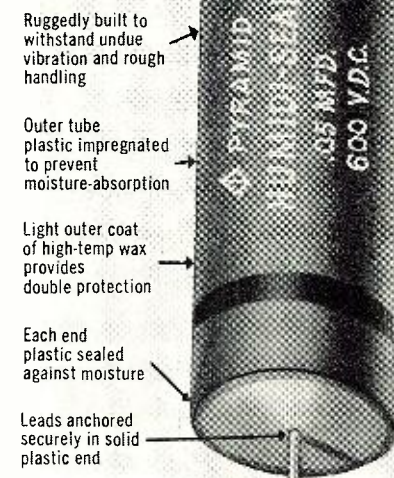

Ruggedly built to withstand undue vibration and rough handling

Outer tube plastic impregnated to prevent moisture-absorption

Light outer coat of high-temp wax provides double protection

Each end plastic sealed against moisture

Leads anchored securely in solid plastic end

Type 85TOC "Humidi Seal" capacitors are specially designed for 85° C. operation, even in the most humid atmospheres, and will meet the severe present-day demands of endurance in television receivers, auto radios, etc.

WRITE FOR COMPLETE LITERATURE

Representatives and Distributors throughout the U.S.A. and Canada



PYRAMID

PYRAMID ELECTRIC COMPANY

155 Oxford Street
Paterson, N. J., U.S.A.

TELEGRAMS: WUX, Paterson, N. J.
CABLE ADDRESS: Pyramidusa

Within the
INDUSTRY

WARREN FREBEL has joined *Majestic Radio & Television, Inc.* of Brooklyn, New York as purchasing agent of the company. Mr. Frebel was formerly purchasing director at *Meck Industries, Inc.* for a period of five years.



During World War II, Mr. Frebel served in the U. S. Signal Corp for four years and prior to his military service was associated with *Wilson & Company*. He attended the University of Illinois.

* * *

DR. PETER C. GOLDMARK has been appointed to the post of vice-president in charge of engineering research and development by the *Columbia Broadcasting System*. He has been actively engaged in the research work in connection with CBS's color television for some time . . . **ROBERT S. BELL**, formerly vice-president and assistant general manager of *Packard-Bell Co.* of Los Angeles, was named executive vice-president of the company at a recent meeting of the board of directors . . . **B. L. BETHEL**, for 25 years a purchasing executive in the electronics and related fields, has been named vice-president in charge of purchasing for *John Meck Industries* of Plymouth, Indiana . . . **W. D. LOUGHLIN** has been elected chairman of the board of *Boonton Radio Corporation*. **DR. G. A. DOWNSBROUGH** and **DR. D. M. HILL** have been named president and vice-president in charge of research and development respectively . . . **R. C. FREYTAG** is the new vice-president of *Scott Radio Laboratories*. He formerly served in executive capacities in the personnel and administration divisions.

* * *

FRANK W. MANSFIELD of *Sylvania Electric Products Inc.* was reappointed chairman of the eleven-man Industry Statistics Committee of the Radio-Television Manufacturers Association.

The committee, composed of marketing research and statistical experts, supervises the compilation of all statistics on the radio-television industry published by RTMA.

Serving with Mr. Mansfield are the following men: L. K. Alexander, *General Electric Company*; E. C. Anderson, *Radio Corporation of America*; George A. Biese, *Crosley Division, Avco Mfg. Corp.*; H. W. Clough, *Belden Manufacturing Co.*; Paul Eashleman, *Allen B. Du Mont Laboratories, Inc.*; P. J. Halligan, Jr., *Philco Corporation*; G. W. Henyan, *General Electric Company*; George McCleary, *RCA*

Victor Division; W. J. Rinkenback, *Capehart-Farnsworth Corp.*; and A. G. Schifino, *Stromberg-Carlson Co.*

* * *

VIBRATION RESEARCH LABORATORIES, INC. has been formed recently by Joseph A. Mas as a research, development, and manufacturing corporation. Headquarters of the new firm are at 152 Sandford Street, Brooklyn, N. Y. . . . John S. Starrett and Russell E. Kraft have joined forces in the formation of a new firm, **UNITED TECHNICAL LABS.** at Morristown, New Jersey. Mr. Starrett was formerly associated with the *RCA Tube Department* while Mr. Kraft was connected with *Sun Dial Corp.* and *Radio Frequency Labs.* of Boonton, N. J. . . . Formation of **ARDEC, INC.**, a Pennsylvania corporation specializing in the production of precision parts and assemblies on a production line basis for the aircraft, automotive, instrument, electronic, and allied industries, has been announced. The company's plant and general offices are located at Media Road and South Orange Street in Media, Pa.

* * *

HOWARD E. ANTHONY, president of *The Heath Company* of Benton Harbor, Michigan, has been awarded the honorary degree of Doctor of Science in Electronics by the University of Hollywood, Hollywood, California.



The degree was conferred on Mr. Anthony "in recognition of the valuable contributions he has made to the industrial electronics field and in further recognition of his genius and skill by which he has made available to the electronics industry and to the electronics engineer essential electronic testing equipment which is now being used in scientific and electronic research work."

The presentation was made by Dr. Oliver Read, editor of *RADIO & TELEVISION NEWS*, at a testimonial luncheon held recently in Benton Harbor.

Mayor Gideon and other leading citizens of Benton Harbor paid tribute to Dr. Anthony for this recognition in the field of electronics and also cited him for his leadership in his community both as an electronic engineer and as one of Benton Harbor's most civic-minded and popular citizens.

* * *

GEORGE P. FRYLING, chairman of the board of *Erie Resistor Corporation*, died recently in Erie, Pa. after a brief illness. He was 85 years old.

Mr. Fryling is survived by two sons,

RADIO & TELEVISION NEWS

IT'S HERE!

The New

HIR

a fully automatic

**ANTENNA
ROTATOR**

by

ALLIANCE

*with the most
accurate indicator
on the market!*



Just set the pointer and forget it!

*Works in any weather
Guaranteed for one year*

The famous Model DIR also available with handy—North—South—East—West indicator. Approved by Underwriters' Laboratories—guaranteed for one year!

And Remember—

Only Alliance delivers a national TV campaign to five million viewers around 60 stations.

*It pays to stock and sell
Alliance Tenna-Rotor!*

AUTOMATIC—the new deluxe model HIR Alliance Tenna-Rotor is fully automatic. Turn the indicator knob and the antenna turns to any setting on the dial and stops.

FASTER INSTALLATION — Easily accessible connections. Uses special "Zip" feature 4-conductor cable. No expensive callbacks necessary.

NEVER OUT OF DATE—mark the best antenna position for each station right on the dial with removable stickers. New channels can be added at any time by customer.

MYSTIC LIGHT — light moves along the dial, shows position while antenna turns. Pointer indicates antenna position at all times. Dial shows North—East—South—West directions.

Alliance Manufacturing Co.
Alliance, Ohio

Export Department: 401 Broadway, New York, N. Y., U. S. A.

alliance
TENNA • ROTOR

(TV ANTENNA ROTATOR)

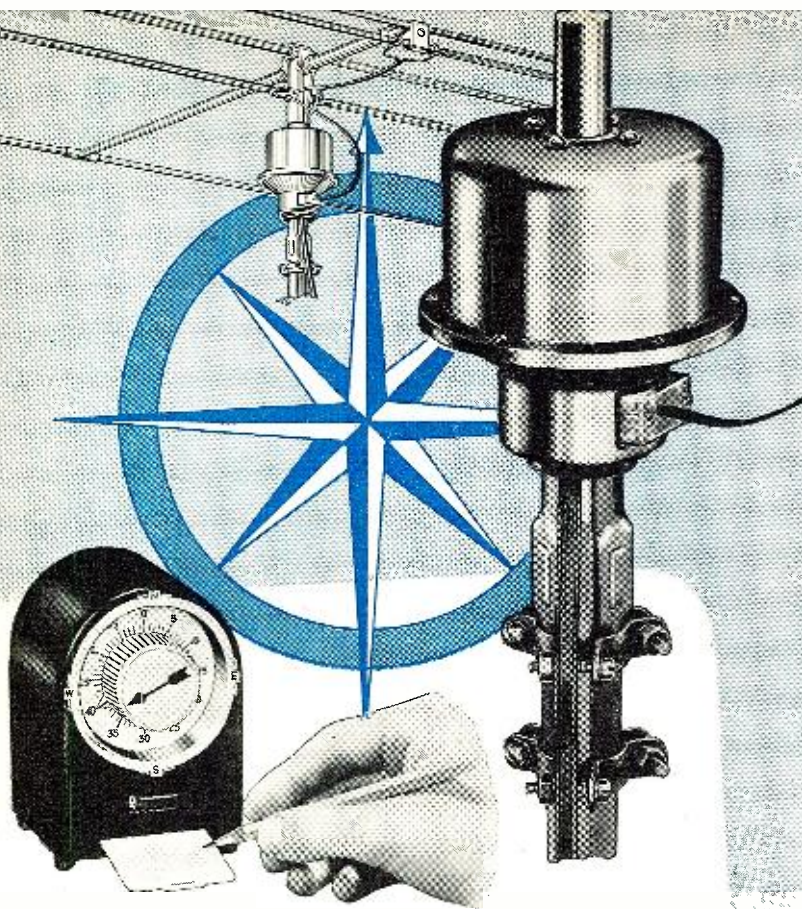

"AUTO-DIAL" TV ANTENNA ROTATOR

With *Automatic* TRAVEL ACTION

AMPHENOL takes pride in announcing the new "Auto-Dial" TV Antenna Rotator. It features an entirely new and different principle of rotator control called "automatic travel action," and represents the greatest single advance in antenna rotators.

There are no tiresome buttons or switches to hold while the antenna is turning. An effortless turn of the knob to the correct setting and "Auto-Dial" takes over. Automatically—just like magic—the antenna follows to point directly at the TV station—then stops!

So accurately does it perform that even a child can "log" antenna positions, accurately returning to them time after time. Rotation is in steps of 6 degrees, accurately calibrated on the indicator. Because of this important feature, servicemen can now determine whether an antenna is functioning properly, whether it has the required front-to-back ratio and whether it is properly located for the best possible picture.

FEATURES

- Completely Automatic—no tiresome buttons or switches to hold while antenna turns!
- Antenna Rotates Rapidly—one revolution every 22 seconds!
- Heavy-Duty Motor, Sturdy Construction—easily handles stacked arrays!
- Housing of cold-rolled steel, copper flashed and with attractive baked-on enamel finish!
- Neoprene Sealed at Factory Against Dirt and Moisture!
- Accommodates Mast Sizes from 3/4" to 2" Diameter!

See It At Your Jobber Or Write For Illustrated Folder
Another AMPHENOL Development For Your Greater TV Enjoyment

AMPHENOL

AMERICAN PHENOLIC CORPORATION
1830 SO. 54TH AVENUE CHICAGO 50, ILLINOIS

G. Richard Fryling, president, and W. Henry Fryling, vice-president of the *Erie Resistor Corporation*.

From 1901 to 1925 he was secretary-treasurer of *Speer Carbon Company* of St. Mary's, Pa., and served as president of the *Elk Graphite Milling Company* of that same city from 1905 to 1935. In 1928 he and his two sons founded the company he headed at the time of his death.

* * *

ANTHONY J. ALBANO, chief engineer of the *Tel-O-Tube Corporation of America*, East Paterson, New Jersey, has been elected secretary of the corporation, according to word received from the company.



Mr. Albano has had extensive experience in radio, electronics, and television. Prior to joining the company two years ago, he served as production engineer for the *Allen B. Du Mont Laboratories*. He is an alumnus of Newark College of Engineering and during the war served as an electronics instructor in the Signal Corps and as a research engineer at the military laboratories in Lexington, Ky.

He succeeds Irving Kagan who resigned as secretary of the *Tel-O-Tube* organization.

* * *

RAY RICE, formerly director of publicity for *Raytheon Manufacturing Company*, died recently in New York Hospital of a heart ailment. He was 49.

A well-known figure in the radio industry, Mr. Rice served as an aide to Major General Karl Truesdell and as a Colonel on the staff of General Omar M. Bradley during World War II.

After his discharge from the army in 1945, Mr. Rice joined *Raytheon* and then a year and a half ago he opened his own public relations firm in New York. He was associated with the late humorist, George Ade, for almost twenty years beginning his public relations career with Mr. Ade upon his graduation from college.

* * *

COLUMBIA BROADCASTING SYSTEM and *Remington Rand Inc.* have announced the signing of a cooperative agreement whereby the two companies will produce color television equipment for industrial, business, hospital, government, and military use.

Under the agreement *CBS* will provide the designs of the equipment, *Remington Rand* will manufacture and sell, *CBS* will perform the testing functions, and *Remington Rand* will then take over distribution and installation. Existing organizations of both companies will be used for the project. The equipment is designed to operate on the standards recommended by *CBS* to the Federal Communications Commission.

The newly designed equipment, to be marketed under the name of "Vericolor," will consist of a simple, compact, lightweight, single-color camera, a control unit with its own color monitor, and as many additional color monitors as may be required. Production is currently underway with delivery expected later this year.

* * *

HAROLD R. TERHUNE has joined the *Mycalex Tube Socket Corporation* of New York and Clifton, New Jersey, as vice-president and will head the standards department of both this company and its affiliate, *Mycalex Corporation of America*.



Mr. Terhune was previously associated with *Radio Corporation of America* where for the past six years he has been in charge of electrical components standardization for the *RCA Victor Division*. Prior to that he was with the *deForest Radio Company* and the *Hygrade Sylvania Corporation* in commercial engineering capacities covering tubes and components.

* * *

BENJAMIN OLNEY, director of research of the *Stromberg-Carlson Company* of Rochester, New York since 1937, has

(Continued on page 118)

There's Real SALES PULL in these Facts about... GENERAL ELECTRIC SPEAKERS!

IT PLAYS UNDER WATER! Submerged in water, the G-E speaker continues to deliver sound reproduction day in and day out. Do you know of any other speaker that will take a similar beating? The answer is in G.E.'s waterproof Voice Coil...the hottest selling feature in any speaker today!



WHEN you're out to corral new business (and what smart dealer or serviceman isn't?) give yourself a head start by selling the line that's booming along today at a dollar volume 40% higher than last-year's record...

General Electric speakers—from the 4" replacement unit to the famous 12" high fidelity champion—are packed with features that assure your customer superb performance and build his confidence in your workmanship. You'll make no mistake when you stock, talk, and sell General Electric speakers!

GREATER MAGNETIC POWER. The stronger the magnet the more sensitive the speaker. Iron filing clusters indicate comparative magnetic strengths...the Alnico 5 alloy used in G-E units is 2½ times as powerful as the standard material previously employed in magnet construction.

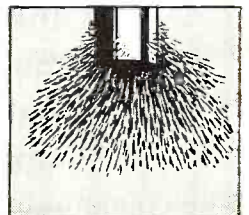
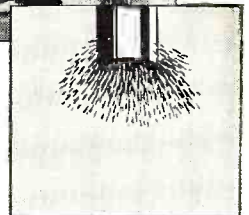

ALL WELD CONSTRUCTION. Rigid enough to support a man's weight, the G-E speaker housing is treated with bright-finish zinc plating...this enables the speaker to resist corrosion long after untreated models have begun to rust.

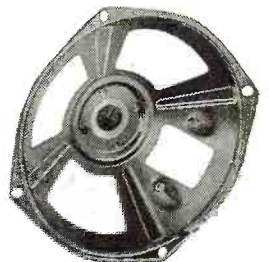

GENERAL ELECTRIC

GET THESE SALES AIDS

Start now to expand your speaker sales. G-E promotion kits help attract new business in home radios, portables, custom installations, drive-in theatres, P.A. systems... Send coupon for full information.



FREE BOOKLET!

General Electric Company, Section 9110
Electronics Park, Syracuse, New York

I'm interested in G-E Speakers. Send me new folder illustrated here.

NAME

ADDRESS

CITY STATE

**Learn more!
Earn
more!**

8 GREAT BOOKS



A. A. GHIRARDI
radio-
electronics
most famous
teacher

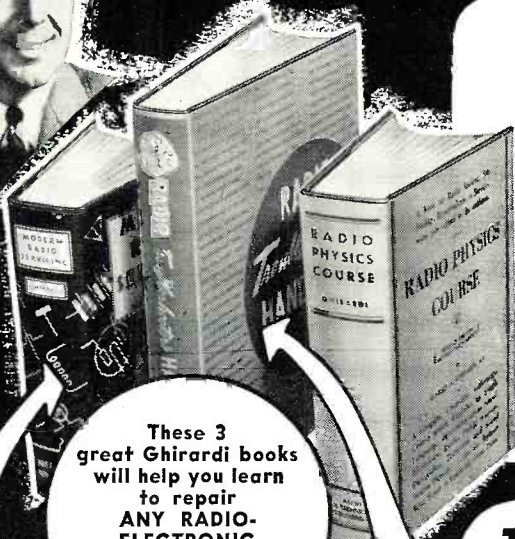

These 3
great Ghirardi books
will help you learn
to repair
**ANY RADIO-
ELECTRONIC
EQUIPMENT**
... easier, better,
faster!

Get complete PROFESSIONAL SERVICE TRAINING

...at home...for only \$5
(\$5.50 outside U. S. A.)

A. A. Ghirardi's giant, 1300-page MODERN RADIO SERVICING gives a complete education in truly professional radio-electronic service work—the kind that pays the real money! Radio itself is only the beginning of this big book's usefulness to you. What it teaches you about electronic circuits, test instruments and professional service procedure is exactly the training you need for a good job in modern electronic-radio-television work!

A COMPLETE GUIDE TO INSTRUMENTS— TROUBLESHOOTING—REPAIR

Read from the beginning, MODERN RADIO SERVICING is a complete service course. Used for reference, it is a quick guide to jobs that puzzle you. Explains service test instruments and how, when and why and where to use each type; how to make preliminary trouble checks; how to analyze circuits; how to replace components; how to speed up your work—and literally dozens of other subjects including How to Start and Operate a Successful Service Business of Your Own. 706 illustrations make study easy. Order Book No. 3 in coupon. Return book in 10 days if not more than satisfied! (SEE OUR MONEY-SAVING OFFER!)

HERE IS YOUR COMPLETE TRAINING IN BASIC RADIO-ELECTRONICS

- 36 courses
in one!
- No lessons to
wait for!
- Learn fast—
Learn right!

No matter what part of ELECTRONICS-RADIO-TELEVISION work you plan to enter, a knowledge of basic fundamentals is essential. Ghirardi's world-famous 972-page RADIO PHYSICS COURSE book gives exactly the training you need—for only \$5 complete (\$5.50 outside U.S.A.) If sent as monthly lessons, you'd regard it as a bargain at \$50 or more! Written for beginners, RADIO PHYSICS COURSE starts with Basic Electricity—then takes you step by step through Radio-Electronics principles. You can easily understand it without previous training. Actually it has given more beginners their start than any other book or course. During the war it was more widely used for Signal Corps and Navy basic training than any other book of its kind. Read it for 10 days at our risk. Order Book No. 1 in coupon!

This "AUTOMATIC TEACHER" shows HOW TO REPAIR OVER 4800 RADIO MODELS

... without expensive test equipment

Ghirardi's big manual-size, 744-page RADIO TROUBLE-SHOOTER'S HANDBOOK is a dependable guide to locating and repairing the common troubles in the most widely used radios, auto radios and radio-phonograph combinations. Whether you repair radios for a living or work with them occasionally, this book will save you time and money on a big percentage of jobs—especially on older sets where data is so often lacking. Eliminates useless testing!

Just look up the case history notes on the old radio you want to fix. RADIO TROUBLE-SHOOTER'S HANDBOOK tells what the trouble is—what causes it—and exactly how to repair it, often in half the usual time. Hundreds of additional pages contain valuable data on tubes, parts and equipment plus graphs, diagrams and money-making service hints. Ideal for training new service helpers. Worth another man in the average shop! Price only \$5 (\$5.50 outside U.S.A.). Order Book No. 2 in coupon. 10-day money-back guarantee.

**MONEY
SAVING
OFFER!**

Make your servicing library really complete! Get BOTH Ghirardi's RADIO TROUBLE-SHOOTER'S HANDBOOK (Book No. 2) and MODERN RADIO SERVICING (Book No. 3) at the special price of only \$9.50 for the two. (\$10.50 outside U.S.A.) Use coupon today!

IT PAYS TO KNOW HOW TO USE THE OSCILLOSCOPE *fully!*

Learn to use the oscilloscope fully on service and laboratory jobs—and watch your efficiency and earnings soar! MODERN OSCILLOSCOPES AND THEIR USES makes it easy! First, this great book gets right down to earth in explaining oscilloscopes and showing exactly how and where to apply them on AM-FM and TV jobs. Then, in easily understood terms, you learn all of the tricks of using this handy instrument—from locating receiver troubles to aligning and adjusting the most complicated circuits. Complete chapter sections deal with television and AM and FM servicing and show how the oscilloscope can solve many of your toughest problems.

CHOCK FULL OF HOW-TO-USE-IT DATA

Each oscilloscope operation is carefully explained including the making of connections, adjustment of circuit components, setting controls and analyzing patterns. About 400 illustrations including dozens of pattern photos make things doubly clear. Price \$6 (\$6.50 outside U.S.A.). Order Book No. 4 in coupon. Read it for 10 days at our risk!

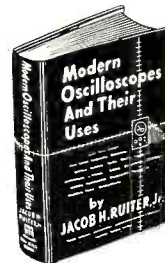

**What it is! How
it works! Exactly
how to use it on
the job!**

READ ANY OF THEM FOR 10 FULL DAYS

TO HELP YOU INCREASE YOUR MONEY-EARNING POWER!!



... This big book MAKES AUTO RADIO REPAIR TWICE AS EASY!

Includes over 500 car radio circuit diagrams



There are more auto radios in use than ever before. Be the well paid expert who can repair them!

Here—written by a leading auto radio expert—is everything needed to help the beginner or experienced serviceman gain profitable skill in this fascinating field. **SERVICING THE MODERN CAR RADIO** describes installation, testing and repair methods fully. Also, it gives needed special data on car radio circuits, differences between car and home radio servicing problems, shop set-up and business getting methods. Covers antenna installations; loudspeaker servicing. Input circuits; power supplies; car radio alignment; circuit features; auto electrical systems; set installations; interference cures; vibrator maintenance and dozens of other subjects. In addition, there are 500 actual car radio circuit diagrams that are worth the entire price of the book to the busy service shop! 702 manual-size pages. Price \$7.50 (\$8.00 outside U.S.A.). 10-Day money-back guarantee. Order Book No. 5 in coupon.

Train for better pay in TELEVISION SERVICING!



Here, in one handy, 334-page volume is a complete guide to installing and servicing television receivers. **PRACTICAL TELEVISION SERVICING** tells you what to do—how to do it—how to set up shop—what mistakes to avoid. Clearly explained are the differences between radio and TV work. Included are dozens of actual TV service case histories and full explanations of wiring, repair and component replacement techniques, antenna erection, TV installations, etc. Also, you get dozens of helpful tips on testing, improving picture linearity, getting good fringe area reception, and other vital TV service data. In a way you can easily understand, it shows step by step exactly how to do the work. Price only \$4.00 (\$4.50 outside U.S.A.). Our 10-day money-back guarantee protects you absolutely. Order Book No. 8 in coupon.

LEARN ELECTRIC MOTOR REPAIR



It pays to specialize in something different!

There's big money in installing, maintaining and rewinding electric motors! Actually, there are more motors than any other type of electric appliance—and the field is growing every day.

Based on what can be learned from this 500-page **ELECTRIC MOTOR REPAIR** book alone, you can train quickly for this profitable field. Explains every detail of motor trouble shooting, repair and rewinding. Covers all types of a-c and d-c motors in common use plus motor control systems. Quick reference guides show how to handle specific jobs. Every type of work is explained in the text AND ALSO visually by more than 900 helpful drawings, photos and diagrams. Practice from the book for 10 days on our money-back guarantee offer. Price \$5.00 (\$5.50 outside U.S.A.). Order Book No. 6 in coupon.

Shows you how—every step of the way!

FREE!

WITH YOUR PURCHASE OF TWO BOOKS OR MORE

Here's an offer you can't afford to miss! With your purchase of ANY TWO of the eight books shown on these pages, we will GIVE you one of the following famous MHB Manuals in Applied Electricity. Your purchase of four regular books entitles you to two of the Manuals—AT NOT ONE CENT OF EXTRA CHARGE. Indicate your choice of gift books on coupon.

Manual A—INDUSTRIAL ELECTRIC WIRING
Construction, operation and maintenance data on a-c and d-c systems. 336 pages, over 100 illus. (Regular price \$2.75).

Manual B—PRIMARY AND STORAGE BATTERIES
Data on selection, maintenance and use—plus rectifiers, charging generators and battery controls. 168 pages profusely illustrated. (Regular price \$2.25).

Manual C—ELECTRICAL MEASURING INSTRUMENTS
Operating principles and details of all industrial types including guides to instrument selection and use. 284 pages, over 200 illus. (Regular price \$2.50).



HERE'S WHAT YOU OUGHT TO KNOW ABOUT FM

FM is a mighty important part of radio—and, with its wide use in Television, mobile units and high-fidelity reception—is becoming more so every day! Written by a well-known expert, this book **FREQUENCY MODULATION** makes it easy for you to understand FM fundamentals and equipment clearly. Equally important, it explains how to handle FM service work.

Basic FM theory, circuits, transmitters, receivers and mobile FM are discussed in an easily understood manner—with special emphasis on modern methods of installing, adjusting and repairing FM receivers. Other subjects include FM circuit peculiarities; tuning indicators; antennas; FM test units; receiver alignment; general servicing procedure and many others. A complete guide to one of electronic's fastest-growing yet least understood developments! 448 pages, over 300 illustrations. Price \$5 (\$5.50 outside U.S.A.). Order Book No. 7 in coupon.

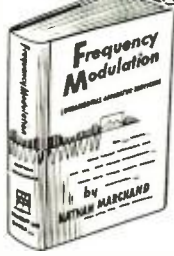

A complete money-making guide to FM theory and service procedure.

10-DAY MONEY-BACK GUARANTEE COUPON

Dept. RN-110, MURRAY HILL BOOKS, Inc.
232 Madison Ave., New York 16, N. Y.

Enclosed find \$_____ for books checked below: or send C.O.D. and I will pay postman this amount plus postage. In either case, it is understood I may return books after 10 days and you guarantee to refund my purchase price promptly. (No C.O.D.'s if you live outside U.S.A. Cash only, but same 10-day return privilege.)

- Send the following books
- | | | | |
|-------------------------------------|-------------------------------------|-------------------------------------|-------------------------------------|
| <input type="checkbox"/> Book No. 1 | <input type="checkbox"/> Book No. 2 | <input type="checkbox"/> Book No. 3 | <input type="checkbox"/> Book No. 4 |
| <input type="checkbox"/> Book No. 5 | <input type="checkbox"/> Book No. 6 | <input type="checkbox"/> Book No. 7 | <input type="checkbox"/> Book No. 8 |
- As per above offer send following gift Manuals at no extra charge:
- | | | |
|-----------------------------------|-----------------------------------|-----------------------------------|
| <input type="checkbox"/> Manual A | <input type="checkbox"/> Manual B | <input type="checkbox"/> Manual C |
|-----------------------------------|-----------------------------------|-----------------------------------|

Name

Address

City, Zone, State.....

PRINT OR WRITE CLEARLY

Read any of them for 10 FULL DAYS . . . at OUR risk!

.. AT OUR RISK!



Here are some of the many reasons why there are more Simpson 260 high sensitivity volt-ohm-milliammeters in use today than all others combined. The Simpson 260 has earned world-wide acceptance because it was the first tester of its kind with all these "Firsts":

Simpson 260 SET TESTER

WORLD FAMOUS FOR ALL THESE "FIRSTS"

- First high sensitivity instrument to use a metal armature frame.
- First to use fully enclosed dust proof rotary switch with all contacts molded in place accurately and firmly.
- First to do away with harness wiring.
- First to provide separate molded recesses for resistors, batteries, etc.
- First to cover all resistors to prevent shorts and accidental damage and to protect against dust and dirt.
- First with a sturdy movement adapted to the rugged requirements of a wide range of service work or laboratory testing.
- First to provide easy means of replacing batteries.
- First to use all bakelite case and panels in volt-ohm-milliammeters.
- First volt-ohm-milliammeter at 20,000 ohms per volt with large 4 1/2" meter supplied in compact case (size 5 1/4" x 7" x 3 1/8").
- First and only one available with Simpson patented Roll Top Case.
- First to provide convenient compartment for test leads (Roll Top case).
- First to offer choice of colors.

RANGES

20,000 Ohms per Volt DC, 1,000 Ohms per Volt AC
VOLTS: AC & DC—2.5, 10, 50, 250, 1,000, 5,000
OUTPUT: 2.5, 10, 50, 250, 1000
MILLIAMPERES, DC: 10, 100, 500
MICROAMPERES, DC: 100
AMPERES, DC: 10
DECIBELS: (5 ranges)—12 to +55 DB
OHMS: 0-2,000 (12 ohms center), 0-200,000 (1200 ohms center), 0-20 megohms (120,000 ohms center).

Prices: \$38.95 dealers net; Roll Top \$45.95 dealers net.

Simpson
 INSTRUMENTS THAT STAY ACCURATE



The Model 260 also is available in the famous patented Roll Top safety case with built-in lead compartment. This sturdy, molded, bakelite case with Roll Top provides maximum protection for your 260 when used for servicing in the field or shop.

25,000 volt DC Probe for television servicing, complete, for use with 260, \$12.85

SIMPSON ELECTRIC COMPANY • 5200-18 W. Kinzie St., Chicago 44, Ill. • In Canada: Bach-Simpson, Ltd., London, Ont.

RADIO & TELEVISION NEWS

Be Sure of Your Installations – Get the *Aptitude-Tested* TRANSMISSION LINE

APTITUDE RATING No. 8225

Frequency (mc)	Attenuation per 100 ft
100.	1.1
200.	1.7
300.	2.2
400.	2.7

For use with television and FM receiving antenna. Exceptionally low losses at high frequencies.

APTITUDE RATING No. 8235

Frequency (mc)	Attenuation per 100 ft
100.	1.10
200.	1.73
300.	2.28
400.	2.74

For use with television and FM receiving antenna; also for low-power transmitting antenna.

APTITUDE RATING No. 8227

Frequency (mc)	Attenuation per 100 ft
100.	4.1
200.	6.4
300.	8.4
400.	10.2

For use with television and FM antenna in extremely noisy locations.

APTITUDE RATING No. 8240

Frequency (mc)	Attenuation per 100 ft
100.	4.10
200.	6.20
300.	8.00
400.	9.50

For use with radio frequency transmission video, test equipment, and pulse transmission.

You know what you are doing when you use Belden Transmission Line Cables—they're aptitude rated. They are designed from the start to provide desirable electrical characteristics, and rigid manufacturing control assures constant, unwavering quality.

You can safely put Belden Wire to work for you, and know for sure how it will perform. You can know, too, that it will have the stamina to stay loyally on the job for years. For trouble-free installations, specify Belden Radio Wires.

Belden Manufacturing Company
4681 W. Van Buren Street
Chicago 44, Illinois

Belden
Radio WIRE

The
Aptitude-Tested **LINE**

Buy a Package of LUXURY LISTENING



Music Lovers: Compose Your Own
HIGH-FIDELITY COMBINATION

Lafayette

HOME OF
GREAT NAMES in
HIGH-FIDELITY
EQUIPMENT

The grouping of loud speaker, amplifier, tuner and record player shown here is but one of a great variety of "Packages" of High Fidelity Equipment available at Lafayette for your listening pleasure. Perfect for custom installation in walls, shelves, bookcases or cabinets. We can supply these packages for as little as \$132.64. High fidelity packages can be made up for every purpose and every purse — all of them first rate buys, all of them of unexcelled quality. If you can, visit our Sound Centers where in a matter of moments, our sound engineers can hook up any combination of high fidelity components for your critical appraisal. Send for free High Fidelity Guide.

GARRARD Record Changer

Model RC-80. World-famous Garrard "Triumph" all-speed automatic record changer. Plays records of ALL speeds and ALL sizes. Stops automatically after last record. Once records are placed on changer and simple settings made, you sit back and enjoy record reproduction at its finest. Accommodates crystal, magnetic or variable reluctance pickup cartridges.

SCOTT Amplifier

Model 210-B. New Scott amplifier with improved DYNAURAL Noise Suppressor. Virtually eliminates record surface noise without affecting musical highs or overtones. 12 to 20,000 cycles frequency range at 20 watt rated output. Harmonic distortion of less than 1/2 of 1% at 20 watts. DC-operated pre-amplifier. Automatic loudness control maintains constant apparent quality at all volume levels. Has Loudness, Frequency Range, Bass, Treble, and Dynaural controls. Input provision for phono, tuner or other equipment. Complete with tubes and instructions.

BROWNING F.M.A.M. Tuner

Model RJ20A. Features the genuine Armstrong FM circuit and has separate RF and IF systems for both the broadcast and FM bands. Has a tonal response from 15 to 15,000 cycles per second. Especially designed for custom installations in high fidelity systems. Has separate bass and treble controls as well as separate television and recorder inputs. Utilizes a tuning "eye" for precise tuning on both FM and AM bands. One of a series of fine Browning tuners for every radio application.

STEPHENS Speaker

Model 102FR is a 15-inch super cospiral speaker capable of handling 20 watts of audio with excellent fidelity. Frequency range from 30 to 14,000 cycles per second makes it ideal for FM, AM and the highest fidelity recordings. Has a 4 1/2 lb. Alnico V magnet to insure the power necessary for superior quality. This is only one of several Stephens Trusonic speakers for hi-fi reproduction, available from \$44.10 up.



*Lafayette... FAMOUS FOR
High-Fidelity IN*

FAMOUS HOMES EVERYWHERE

Radio Wire Television Inc.

110 FEDERAL ST.
BOSTON 10, MASS.

24 CENTRAL AVE.
NEWARK 2, N. J.

100 SIXTH AVENUE
NEW YORK 13, N. Y.

542 E. FORDHAM RD.
BRONX 58, N. Y.

NAME _____
ADDRESS _____
CITY _____ STATE _____
ZONE _____

- 31A22623—Garrard RC-80 Changer, less cart.\$36.06
- 2N462—H. H. Scott 210-B Amplifier\$185.71
- 30N22481—Browning Model RJ20A F.M.A.M. Tuner\$159.25
- 22D21386—Stephens Model 102FR Speaker\$60.27
- Send FREE High Fidelity Book.

Radio Wire Television, Dept. RK50
100 Sixth Avenue, New York 13, N. Y.
Enclosed please find postal note,
money order or check for \$ _____
for which ship me the items I
have checked. I am including
shipping charges.

**USE THIS COUPON
TO ORDER NOW!**

NOW READY! A Sensational New Line Of
1951 MIDWEST TELEVISION

Complete CHASSIS and BEAUTIFUL CONSOLES
Featuring the New MAMMOTH **19 1/2** Inch PICTURE TUBE

FACTORY-TO-
 YOU on
30 DAYS TRIAL

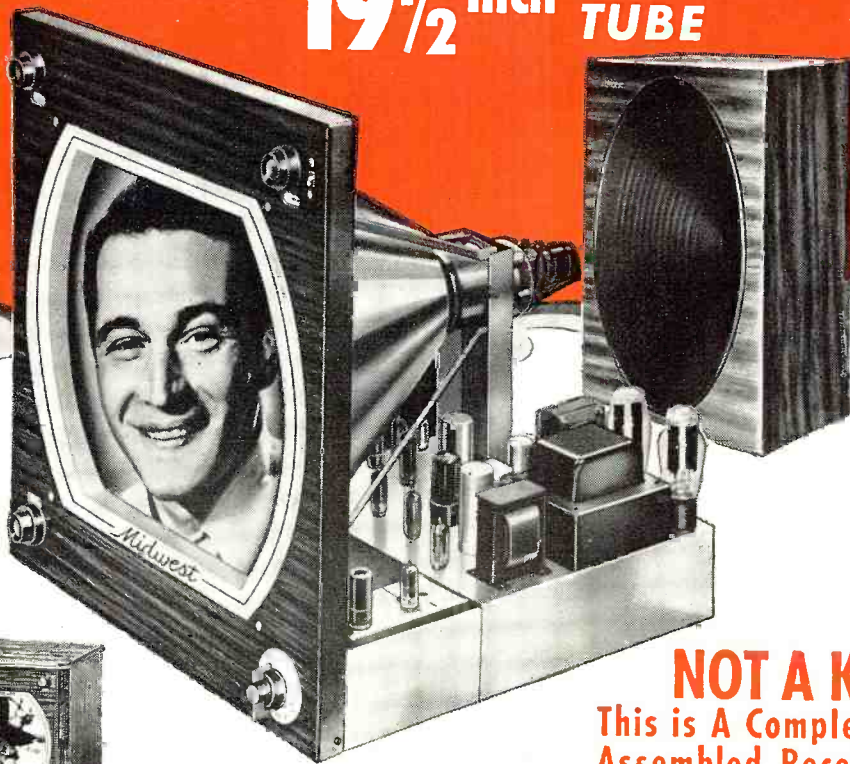

"VIDEO GRAND"
 19 1/2-Inch Picture (225 sq. in. image) Television-Radio-Phonograph Console

EASY TERMS

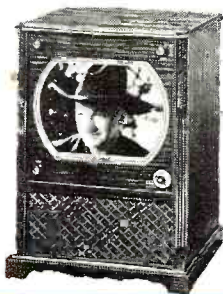

"CONSTELLATION"
 19 1/2" Television Console with BIG 12" Panasonic Speaker

NOT A KIT!
 This is A Completely Assembled Receiver

Never before have you seen such tremendously BIG clear pictures, such luxurious cabinets, such sensation-ally low Factory Prices as Midwest offers in its 31st Anniversary Line of 19 1/2-Inch and 16 1/2-Inch Television receivers. They are available in complete ready-to-use chassis for custom installation in your own cabinet...or in luxurious console cabinets with Television only or in TV-Radio-Phonograph combinations. All are offered on Midwest's famous 30 Days Trial right in your own home.

Plus Powerful New 1951 World-Ranging 5-Band
MIDWEST SERIES 16 **RADIOS**
 In Beautiful Consoles and Complete Chassis



An entirely new line featuring the powerful Series 16 AM-FM Five-Band Radio Chassis and the magnificent Symphony Grand Radio-Phonograph with 3-Speed Automatic Intermix Record Player.

EASY TERMS

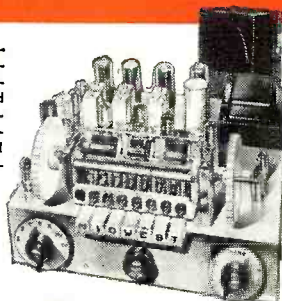

SEND COUPON TODAY
 For This NEW 1951 4-Color

FREE MIDWEST
 RADIO-TELEVISION
 CATALOG



• WRITE IN NAME AND ADDRESS (PLEASE PRINT) ON COUPON OR 1c POSTCARD

MIDWEST RADIO & TELEVISION CORP.
 Dept. 37-D, 909 BROADWAY • CINCINNATI 2, OHIO
 Please send me your new FREE 1951 Catalog.

NAME _____
 ADDRESS _____
 CITY _____ ZONE _____ STATE _____

MIDWEST RADIO & TELEVISION CORP.
 DEPT. 37-D, 909 BROADWAY, CINCINNATI 2, OHIO



How a whiff of stibine led toward lower telephone costs

At the New York Telephone Company's Triangle exchange in Brooklyn, emergency batteries stand ready to deliver 3000 amperes for several hours.

In the Bell System there are a million lead storage battery cells connected to telephone circuits in the central offices. Current seldom flows in or out of these cells beyond the trickle which keeps them charged. In the rare event of power failure, however, they stand ready to supply the current for your telephone service.

Even in this stand-by service, cells require water to make up for electrolysis. And they consume power and eventually wear out. But Bell Laboratories chemists discovered how to make a battery which lasts many more years and requires less attention — by changing a single ingredient, the clue to

which came unexpectedly from another line of their research.

The clue was a minute trace of stibine gas in battery rooms which electrochemists detected while on the lookout for atmospheric causes of relay contact corrosion. In small traces the gas wasn't harmful but to battery chemists it offered a powerful hint.

For stibine is a compound of antimony—and antimony is used to harden the lead grids which serve as mechanical supports for a battery's active materials. Tracing the stibine, the chemists discovered that antimony is leached out of the positive grid and enters into chemical reactions which

hasten self-discharge and shorten battery life.

Meanwhile, in the field of cable sheath research Bell metallurgists had discovered that calcium could be used instead of antimony to harden lead. And theory showed that calcium would not react destructively in a battery. The result is the new long-life calcium-lead battery which cuts battery replacement costs, goes for months without additional water, and needs but $\frac{1}{5}$ the trickle current to keep its charge.

It demonstrates again how diverse lines of research come together at Bell Telephone Laboratories to keep down the cost of telephone service.

BELL TELEPHONE LABORATORIES

Working continually to keep your telephone service big in value and low in cost.



RADIO & TELEVISION NEWS

THE TOP TOWER OFFERS THE BOTTOM PRICE! NEW TELETOWER PRICES ARE 25% TO 60% LOWER.

MAIL COUPON FOR FREE BULLETIN WITH NEW RETAILER PRICE LIST.



ASSEMBLY GUIDE!
Fitting just one leg into pilot hole automatically aligns both sections.

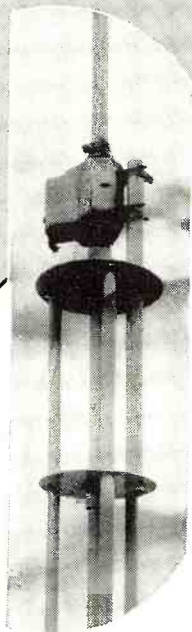

NO WEIGHT ON MOTOR MOUNT! Mount takes all load . . . permits "free" swiveling in any direction.

FITS ANY SURFACE! Hinged base plate permits safe, easy erection on sloping surfaces.

LIGHTWEIGHT! Eight year old boy lifts 10-foot section which weighs less than two pounds per foot.

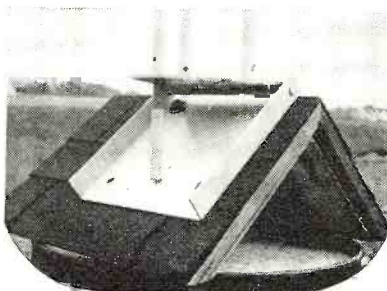

NOW — Penn applies mass production technique to TV tower manufacture! Results? (1) Prices even lower than a former low that set a record. (2) A new, improved tower design. (3) Eight big construction advantages not combined on any other tower at any price.

Penn's low prices — which include prepaid freight east of the Rockies and special shipping cartons that protect finish — are NOT "deals." They are natural results of lower manufacturing costs made possible by the facilities of a factory that was originally established in 1932 and has been growing ever since.

It pays to learn why Teletower sales "tower" above all competition. Paste the coupon to a penny postcard — and mail it today — before you forget!

LEARN ABOUT NEW CONSTRUCTION FEATURES RECENTLY INCORPORATED IN BOTH TELETOWER AND THRIFTOWER AT NO INCREASE IN PRICE. ALSO—WRITE FOR INFORMATION ABOUT COMPLETE NEW LINE OF TENNA-MAST HARDWARE.



Canadian Representative:

J. R. McVITY & COMPANY

53 Dalewood Road, Toronto, Ontario, Canada

**Penn Boiler & Burner Mfg. Corp.
Dept. N-1, Lancaster, Pa.**

Please send me a copy of your Teletower Bulletin complete with new retailer price list.

Name

Company

Address

PENN TELETOWERS . . . THRIFTOWERS

PENN BOILER & BURNER MFG. CORP. — LANCASTER, PA.

CONCORD, CHICAGO

YOUR FIRST CHOICE FOR

High-Fidelity COMPONENTS AND SERVICE



Concord's Exclusive "Selector Rack" takes all the guess work out of buying high-fidelity audio components. It consists of a unique master control mixing panel whereby any combination of components (which are on open display in the "Rack") can be auditioned for tonal quality and frequency response.

Audio Engineers, Experimenters, Amateurs, and all those who demand the very best in High-Fidelity audio equipment look to Concord first for their every audio need. Experience has taught these men the value of doing business with a reliable and well established firm. They know that Concord can supply, at the lowest possible price, the exact merchandise needed for their particular job.

The men who serve you at Concord are essentially engineers, not salesmen. When you visit one of our showrooms or write for advice, you are given friendly counsel by our engineers without the slightest obligation on your part.

So if you are planning a Hi-Fidelity installation be sure to check with Concord first - it will save you time and money.

COMPLETE STOCK OF TOP QUALITY HI-FI COMPONENTS

HI-FI AMPLIFIERS

CONCORD SPECIAL!
MUSIC LOVERS
AMPLIFIER
\$29.50

Especially designed by CONCORD engineers to give the Hi-Fi Fan an inexpensive, good quality unit. Normal rated output 8 watts (harmonic distortion only 2%). 3 inputs for magnetic, and crystal cartridges, and radio tuner; built-in pre-amp for reluctance pickups; separate bass and treble controls with flat position--bass and treble controls with flat position--bass gives 10db boost, treble gives 12db boost and 14db attenuation. Freq. resp. at rated output 40 - 15,000 cps ±1db. Tubes: (2)6V6, 6SL7, 6SC7, and 6X5 rect. For 117 V, 60 cycle AC. Brown hammerloid finish. Size: 10-1/2 x 6 x 5-1/4". With tubes.
2-295R -- Shpg. wt. 10 lbs. \$29.50

- 2-440R - Bell Model 2145. \$145.82
- 2-404R - Bell Model 2122. \$ 44.95
- 2-417R - Brooks Model 12A3. \$187.50
- 2-433R - Electronic Workshop A-20-5 \$148.50
- 2-434R - Electronic Workshop S-20 \$119.50
- 2-438R - McIntosh 50W-2. \$249.50
- 2-435R - McIntosh 20W-2. \$149.50
- 2-436R - McIntosh AE-2 Equalizer. \$ 74.50

HI-FI SPEAKERS

HOLL "LIVING PRESENCE" SPEAKERS



Exclusive Holl Lo-Distortion is accomplished by a new method of plastic treatment of the cone, giving greater compliance. Revolutionary Holl patented crossover network takes out the mid-high peak "plateau" common in high freq. drivers, thus eliminates need for pad between high and low freq. sections. Enclosures are made of 3/4" wood - interior walls lined with acoustical padding.

Model 1000W (Illustrated) 2-way System. 15" woofer has 2 lb. Alnico V magnet, 2" voice coil. Tweeter has Alnico V driver. Rated 20 watts; 15 ohms. Crossover 900 cycles. Freq. response 45-15,000 cps. Cabinet has vented tube porting, mahogany finish. 34 x 13-1/2 x 24.
22-21356R -- Shpg. wt. 65 lbs. \$149.50

OTHER BEST BUY SPEAKERS

- 22-19395R - Altec-Lansing Model 603B \$ 63.00
- 22-19392R - Altec-Lansing Model 604B \$143.00
- 22-19382R - University Model 6201. \$ 44.10
- 22-19385R - University Model 6200. \$ 20.58
- 22-19038R - Jensen Model H-510. \$ 87.32

PLUS complete line of all leading makes including the NEW Electro-Voice Radax Series.

PHONO ACCESSORIES

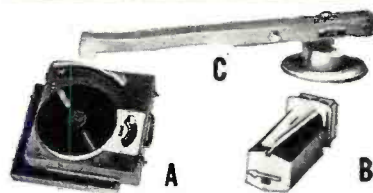

Fig. A. Rek-O-Kut Model CVS-12P Continuously Variable Speed Turntable that plays any RPM from 25 to 100 without wow. Ideal for use in schools, dance studios, broadcast stations, etc. Constant speed, 4 pole motor with internal rim drive. 12" cast aluminum turntable. Noise lever-30 db. Size 16 x 12". 1-1/2" above chassis, 4" below. Housed in portable case. Complete with 16" pickup arm and dual stylus cartridge. For 105-125 V., 60 cycle AC.
34-22640R -- Shpg. wt. 19 lbs. \$124.95
Model CVS-12. Phono-motor and Turntable only.
34-22641R -- Shpg. wt. 10 lbs. \$ 84.95

NEW AUDAX POLYPHASE REPRODUCERS

Fig. B. Wide range magnetic turnover cartridges, operate on 7 grms. needle pressure. Plays all speeds - has replaceable styli. Response 20 - 10,000 cps.
34-13530R - Model R2 Head. \$14.41
34-13531R - Model L6 Head. \$20.29
34-13540R - Fig. C. 12" Arm for above. \$13.52
34-13541R - 16" Arm for above. \$19.40

FREE

YOUR GUIDE TO GREATER SAVINGS.
CONCORD'S CATALOG--JAM-PACKED WITH VALUES!
SEND FOR YOUR FREE COPY, TODAY.

CONCORD RADIO

Mail Order Center and Showroom
901 W. Jackson Blvd., Chicago 7, Ill.
Branch Showroom: 265 Peachtree St., Atlanta 3, Ga.

EXPORT

For PROMPT Service on Export Orders & Inquiries
Address to CONCORD RADIO CORP., EXPORT DIVISION, 901 West Jackson Blvd., Chicago 7, Illinois.

SEND YOUR ORDER TO CONCORD, CHICAGO
For the fastest, most dependable service order from our vast Chicago Mail Order House - located in the center of the Electronics Industry.

CONCORD RADIO CORP. Dept. RL-50
901 W. Jackson Blvd., Chicago 7, Illinois.

Send FREE latest Catalog and Bargain Bulletin.

Name.....

Address.....

City..... Zone..... State.....



....."Sells for me

BIG!"

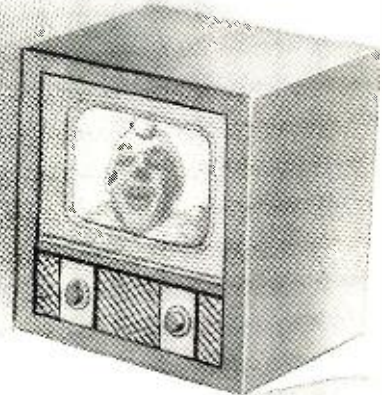

"G.E.'s the hottest name in tubes. My turnover is evidence."

"THIS handy tube merchandiser has the G-E monogram *big* on top . . . illuminated, too. That's why it makes buyers out of callers—turns my tube stock into cash for a mighty fine profit showing!" You hear this everywhere from radio-TV servicemen who have given the green light to G-E product popularity . . . And General Electric's success pattern for dealers is so easy to follow! Waiting for *you* is the attractive new 200-tube Selector-Salesman shown here. Ask your G-E tube distributor how to obtain one; then rub your eyes as tubes become dollars, faster than ever before! . . . Other G-E colorful displays and signs, hard-hitting promotion pieces, high-voltage advertising aids—all are ready to help you **SELL**. Phone, wire, or write your distributor today! *Electronics Department, General Electric Company, Schenectady 5, New York.*



***NOW...full page G-E tube ads
IN "LIFE" AND THE "SAT. EVE. POST"!***

Another big boost to your sales! Millions of radio-TV owners are reading, in national magazines, the dramatic story of G-E tube leadership. **YOU** benefit!

You can put your confidence in—

GENERAL  ELECTRIC

THE FACTS

about hallicrafters



dynamic tuner

with the **PRECISION PRINTED CIRCUIT**

1

TELEVISION'S clearest picture!

Located at the beginning of TV chassis where signals are the weakest, the dynamic tuner uses the photographic accuracy of the precision printed circuit: TO AMPLIFY WEAK SIGNALS MORE EFFECTIVELY; TO REJECT STATIC OR OTHER INTERFERING SIGNALS.

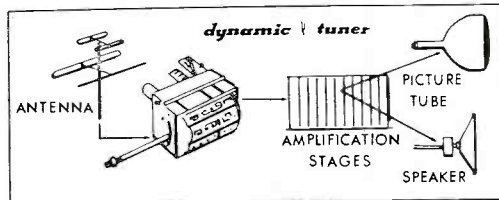

2

ACTUAL PROOF OF SUPERIORITY!

HALLICRAFTERS . . . BEST of five leading sets tested! Two to four times *greater sensitivity* than the best of the other leading TV chassis tested, and on *all 12 TV channels!*

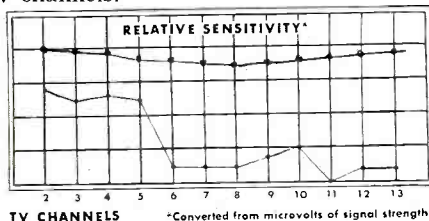

3

"FRINGE AREAS" MOVE TO TOWN!

Hallicrafters longer-distance reception means that you, the dealer, have a greater sales territory! It's yours to capture, now! You can guarantee "city-clear" reception in many former "fringe area" locations.

4

SUPER-SENSITIVE CHASSIS

Every chassis coming off the line is "hot" in sensitivity; variations in tuning alignment are practically eliminated! Neither climatic changes nor motion in shipment alter the precision-fixed position of the flat, photo-etched coils.

5

EXCLUSIVE: "SILVER VORTEX ANTENNA"

Hallicrafters' second major development in antennas, the Silver Vortex Antenna is a triumph of Precision engineering. It is "omnidirectional," actually *draws in* signals like a magnet through a precision-printed, circular pattern of metallic silver ribbons.

WORLD'S LEADING MANUFACTURER OF PRECISION RADIO & TELEVISION
CHICAGO 24, ILLINOIS





Problems In PHONOGRAPH RECORD REPRODUCTION

By

JOHN D. GOODELL

The Minnesota Electronics Corp.

A discussion of the characteristics required of styli, pickups, and tone arms used in high-quality systems.

Three representative record changers. Clockwise from the left hand corner; the V-M Model 950, the Milwaukee Stamping Company's Model 11600 unit, and Zenith's new "Cobra-Matic" with variable speeds from 10-85 r.p.m.

A MUSIC reproducing system is a chain of elements, and nowhere is the old saying about the weakest link controlling the system more valid. This article has to do with the first links in the chain of record reproducing components: the stylus, the pickup, and the tone arm structures.

The earliest element in the signal input section is the stylus, and its importance is appreciably greater than is realized by most engineers and technicians. The stylus has the task of traveling a road that is tortuous, complicated, and replete with unbelievably sharp turns. It is required to course along this path at high speeds, maintaining perfect contact with the sides of the road at all times, accepting the friction and shock involved with changing direction 10,000 times per second and simultaneously traveling at a rate of forty or more inches per second along the groove. Its total travel, of course, includes the complex side trips involved in the modulation. Where long playing microgroove records are involved, the turns are sharpened and crowded together to the point where a careful examination of the problems would lead many to believe that it just isn't a practical way to reproduce music.

Obviously it is essential that the fit between the stylus and the groove be as perfect as possible. With microgroove records the dimensions involved

are extremely small, and not only the over-all shape of the stylus but the very texture and polish of the surface are of real importance. Studying these problems leads to the conviction that nothing less than a perfectly polished diamond is really satisfactory for the purpose. As a practical matter, for general purpose applications sapphire and even osmium and other metal alloys may be used. For playing records of popular tunes that will soon be discarded in any event, they are not too unsatisfactory.

The damage done to the stylus by friction with abrasive dust in the grooves is more serious than is generally realized, and happens much faster than might be expected. In tests where microgroove records have been played with ideal equipment in air conditioned, dust-free chambers, the life of diamond styli and records has been shown to be many thousands of hours. Using the same equipment in ordinary atmospheres the normal accumulation of abrasive dust may shorten this to a thousand hours or less, even for a diamond stylus. When other factors are included, such as poor bearings in the arm, vibration in the turntable, etc., the life expectancy of any stylus is greatly shortened. It becomes clear that a factor of primary importance in preserving both styli and records is minimizing of abrasive dust. With plastic materials such as vinylite which are used for all long

playing types, very high electrostatic charges are developed by frictional contact with the record envelope, the turntable, and the actual playing of the record. The use of an anti-static agent designed for the purpose is of considerable value in eliminating the problem of dust attracted to the record surface by these charges.

It is interesting, and not generally known, that shellac records are inherently capable of greater crispness at the high frequency end than are the plastic types. The reason is that the shellac is hard and relatively brittle, and it presents a surface to the playback stylus that does not permit it to deviate from the path originally traced by the cutting stylus. Vinylite records have considerably more elasticity, and under the heavy pounding of high frequency, high modulation passages the sides of the grooves will deform, permitting the stylus to slide by without tracing the complete brilliancy of the original master. The shellac records, on the other hand, suffer from breakdown of the walls of the groove and small particles of shellac and abrasive dust are poured into the grooves, later to be ground in by repeated travel of the stylus with resultant increases in noise level. Fortunately, vinylite has an excellent elastic memory and the deformation of the walls is only temporary so that these effects are not cumulative.

It is important to remember that in

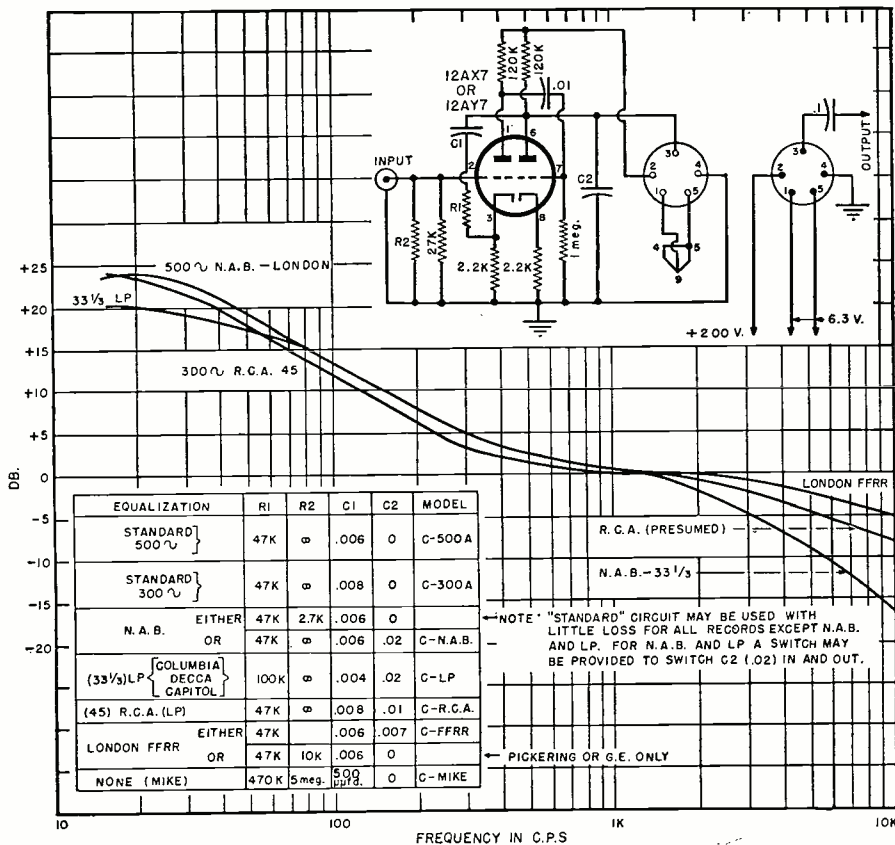

Fig. 1. Diagram of the Goodell plug-in preamp equalizer and associated equalization curves.

pounds-per-square-inch the six grams ordinarily recommended for long playing stylus pressure corresponds to approximately an ounce of pressure on standard styli. A very small deviation in total pressure produces a very large change in pounds-per-square-inch, and it is well worthwhile to take the trouble to adjust the stylus pressure to as low a value as is consistent with satisfactory tracking of the grooves. If the pressure is too low it will, of course, allow the stylus to rattle against the walls of the groove with equally disastrous results. It is probably better to err slightly on the too heavy side rather than using too light a pressure because most arms, most turntables, and many records have inherent faults that operate to increase the problems where too light a pressure is used.

With most record changers it is very important to adjust the angle of the stylus with respect to the groove in such a manner that the deviation from normal is averaged over a stack of records. A problem that is not generally given sufficient consideration is the matter of the stylus dropping on the record surface when the arm is released by the changer mechanism. Careful adjustment to minimize this is well worthwhile, not only because of possible damage to the stylus but also because continued dropping often deforms the cantilever spring suspension of magnetic cartridges and some crystals. In many installations where little attention is paid to this factor, the service technician will find the lower surface and even the sides of

the cartridge case worn down from contact with the record as a result of the fact that the stylus has gradually receded from continued shock. One excellent solution to this is found in the design of the *Lincoln* changer. This mechanism was designed by engineers of a firm that specializes in the manufacture of grease guns and similar equipment. Logically, when they set to work to design a record changer they operated everything possible by pneumatic means. It is an advantage that only one record is on the turntable at a time, but in addition to this the stylus is gently lowered to the surface by a pneumatic valve, and there is no mechanical shock.

Considerable experimental work has been done with the shape of stylus tips and a few investigators have reported improved results with a slightly oval shaping. Others have concentrated on producing an all-purpose design that may be used for both standard and long playing records. It is the tendency of the engineer to strive for perfection, but it must be borne in mind that the general public is often willing to accept a considerable compromise with such perfection if increased ease of handling is a factor. It's a nuisance to change cartridges or styli in going from one speed to the other. For people who use music as a background for other activities where they are not listening critically to the details of performance, the general purpose stylus is probably a valuable contribution. With a stylus that is too large for the microgrooves there will be some loss of high frequencies and some increase

in record wear, but in some applications and for some listeners the loss of highs is of no consequence and the increase in wear may not be considered serious. With standard records the slightly too-small stylus will rattle and produce distortion at high frequencies, and again the lasting properties of both record and stylus will suffer. There is little doubt that the large grooved records will eventually become museum pieces and this problem will vanish, but it will be a good many years before such a changeover will be complete.

The problem of equalization for various records is still with us, and will be for quite a while, but there appears to be an excellent chance that the various manufacturers will strive to set and maintain standards that will eliminate this before too long. The difference in equalization curves has perhaps been over-emphasized at times in the literature. It will always be true that the acoustic conditions under which the recording is made will exert an equal or greater influence over the frequency response characteristics of the record than the electrical equalization curves in the recording equipment. Although most manufacturers of pickups go to considerable trouble to provide the customer with circuits and methods of suitably terminating the cartridge for optimum equalization, a great deal of this material goes unread. Continually letters are received from users of magnetic cartridges who complain that the high frequency response on long playing records is excessive, and it is found that they are terminating the pickup in the same resistive load they have always used for the standard cartridge. The resistive load into which either a crystal or magnetic cartridge works makes a very large difference in its response characteristics. In general, the low frequency response of a crystal increases directly with an increase in the size of the terminating resistor. Conversely, the high frequency response of a magnetic cartridge goes up with increased size of the resistive load. One of the factors that continually confuses the novice in working with magnetic cartridges is the matter of shunt capacitance. It has been the practice for so long to think of designing simple high frequency tone controls with a capacitance that shunts some portion of the signal circuits, and to worry about shunt capacitance in the wiring diminishing the high frequency response, that the misunderstanding of the problem is not strange. Actually, with magnetic cartridges a shunting capacitance in the range of values normally used for this purpose will resonate with the coil of the cartridge to produce a high frequency peak. It is for this reason that it is important to keep the shielded lead from the pickup to the preamplifier as short as possible. Where there is inadequate high frequency response as a result of the cartridge or stylus design, it is sometimes practical to insert a small ca-

capitance and produce a peak at the high end with desirable results. The order of magnitude for the condenser will usually be in the range between .0005 and .01 μ fd., but this will vary greatly with the various types of cartridges and the characteristics of associated wiring and circuitry. These simple principles may be used to change the response characteristics of either type of cartridge within very wide limits. Most microgroove magnetic cartridges should be terminated in approximately 2500 ohms for proper equalization of the average long playing recording characteristic at the high end. Where the input resistance of the preamplifier used for playing standard records is approximately 30,000 ohms, a shunting resistor directly across the terminals of the long playing cartridge of approximately 2700 ohms will solve the problem. A quarter-watt resistor may be easily soldered directly on the terminals of plug-in cartridges. With preamplifiers that actually have the proper amount of low frequency boost for standard records, the low frequency response from microgrooves may be excessive. Most preamplifiers do not have sufficient equalization at the extreme low end for standard records. Usually this may be corrected in either direction by slight adjustment of the low frequency tone control.

A considerable amount of material has appeared in recent articles in various publications regarding the Fletcher-Munson hearing curves. These curves show that both the low and high frequency response of the ear falls off at low volume levels. This is a phenomenon that has been known for many, many years, and as long ago as 1930 commercial radio-phonographs used compensated volume controls to make up for this low volume deficiency in hearing. Obviously, if it is desired to reproduce in miniature form the subjective sensation that is involved with full scale performance, it is desirable to boost both bass and treble in order to compensate for hearing characteristics. However, if this is done with an automatically compensated volume control it means that the operator of the equipment is married to the compensation arbitrarily inserted and he can almost never produce a flat curve at low levels. Fixed electrical compensation of this kind does not take into account the characteristics of the loudspeaker or the input signal. It does not allow for the acoustic conditions in the room or the enormous variations in individual hearing and individual subjective concepts of good reproduction. It seems far better to produce a flat basic electrical response and provide tone controls that may be adjusted by the listener to produce optimum results. Again it must be recognized that there is some convenience in the automatic device, and perhaps for the uncritical listener it is a convenience. If such a device is to be used it should at least be inserted only when it is de-

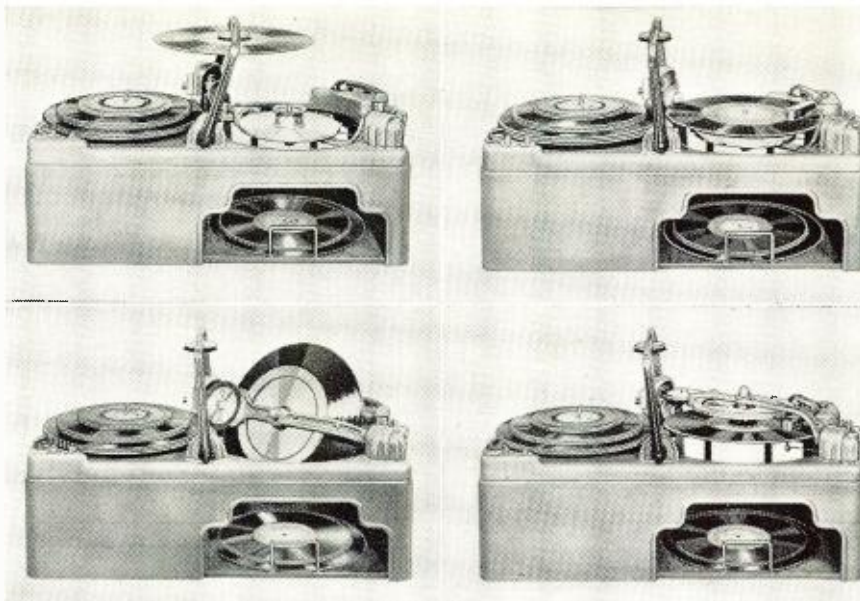

Four views of the Lincoln record changer "in action." (Upper left) The record is placed on the turntable and the first side is played (upper right). The turntable inverts (lower left) and the second side of the record is played (lower right). After second side has been played the record is released to the receiver and the cycle repeats automatically. If the changer is set for "single side" operation, it releases the record without playing the second side. This Series 50 record changer will handle all speeds and sizes of records. Any size and thickness of records of the same speed are handled automatically and may be intermixed in any sequence. Rubber suction cups handle the record and only one record is on the turntable at any one time.

signed specifically in terms of the entire system. Otherwise such factors as loudspeaker efficiency, which varies over extremely wide limits, will completely upset the validity of the automatic compensation curves.

For those readers who are interested in building preamplifiers for magnetic pickups, a circuit is shown in Fig. 1 with a variety of values given for matching various standard recording characteristics. In some instances there is a choice of two methods for achieving substantially the same results. The values that are changed to obtain different equalizing may, of course, be connected in suitable switching arrangements for convenience of the critical listener. As a practical matter, few people find that they actually use such facilities to any great extent.

The subject of tone arms is an important one, and the problems are not too widely understood. The tone arm must support the cartridge, provide the necessary mass for the stylus to work against and permit smooth tracking across the record surface. If records and turntables were manufactured within sufficiently close tolerances, and if records did not warp, then the problems would be greatly simplified, and a tone-arm designed with extremely high mass and good lateral bearings would provide a completely satisfactory device. Unfortunately there are many factors that make this an incomplete and unsatisfactory solution. To begin with, it is important that the arm be free to move vertically in order to track warped records and turntable wob-

(Continued on page 154)

The Pickering Model 190 pickup arm. This arm, used in connection with the proper pickup cartridges, is capable of playing both standard and microgroove recordings. The correct pickup can be plugged into place without weight adjustment, screws, or wires.

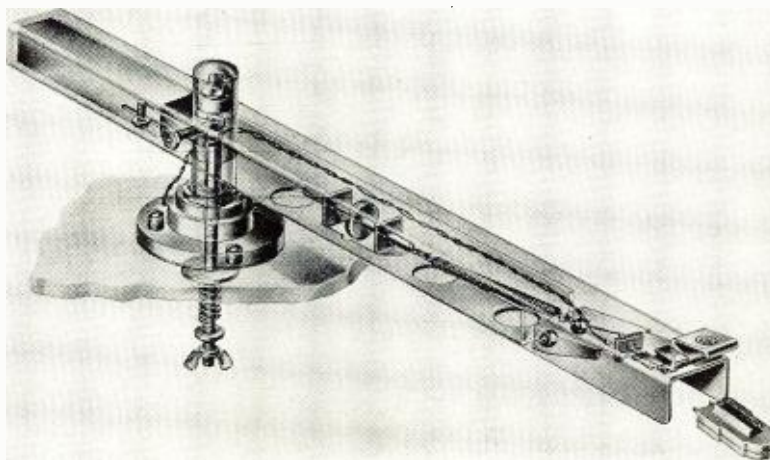

A Flexible RECORD-REPRODUCE SYSTEM

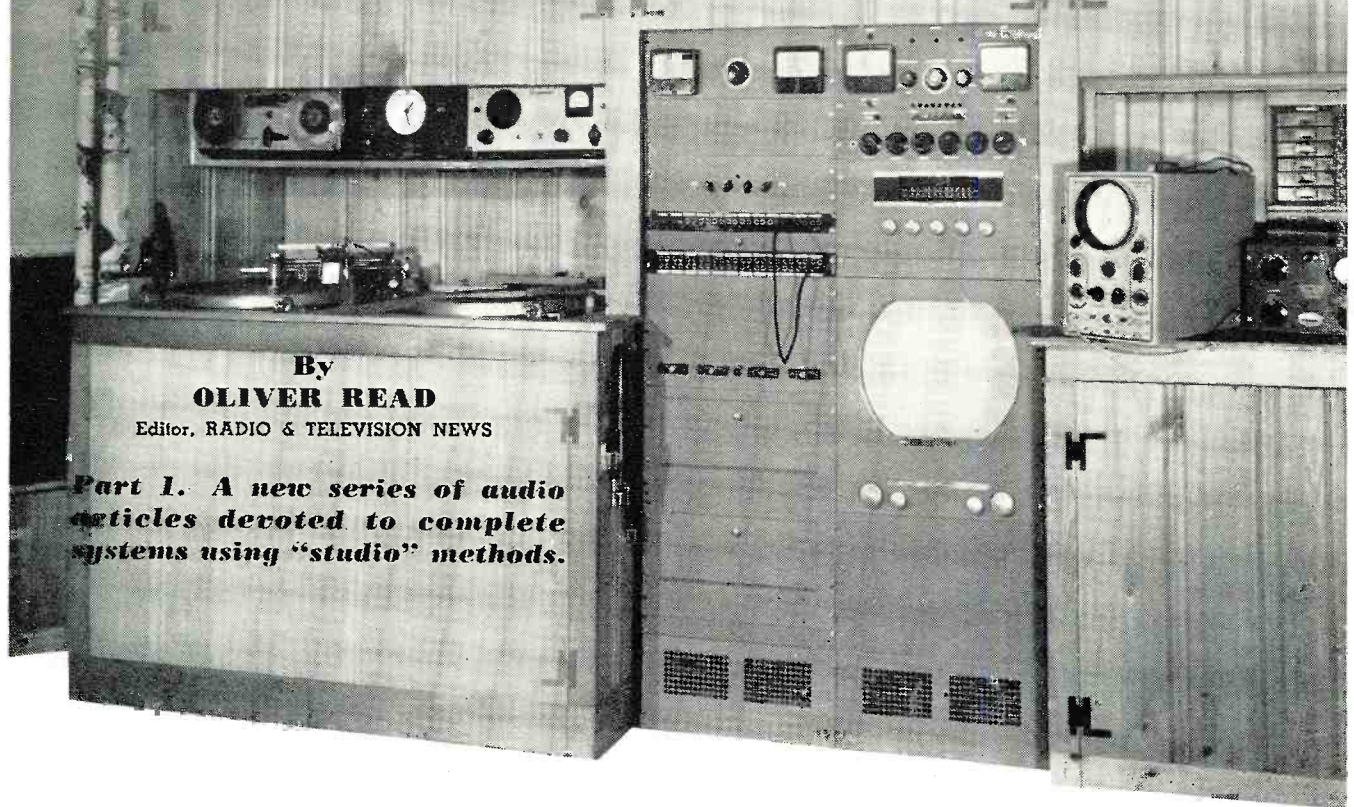

By
OLIVER READ
Editor, RADIO & TELEVISION NEWS

Part I. A new series of audio articles devoted to complete systems using "studio" methods.

▼ HERE are many audio engineers, students, home-recordists, and dyed-in-the-wool enthusiasts who show a keen interest in "customized" audio installations. Generally these men are also interested in setting up complete record-playback systems for the purpose of making audio measurements, for comparative testing, and for the high quality reproduction of music.

The above category includes both those who prefer to build their amplifiers, tuners, and mechanisms and those who choose their equipment from the manufacturer's ads and catalogues.

Numerous articles have appeared in this and other publications, giving complete data on the construction and design of equipment for the recording and reproduction of sound. Our own experience in "rolling our own" has been most enjoyable and satisfying. However, there are many who do not have the time nor desire to build their own audio equipment.

So many requests have been received for information on how to employ commercial audio equipment in complete systems that we have gathered representative units and set to work on a really flexible system, easily duplicated by the average audio man. By using techniques employed in re-

ording studios this system provides numerous combinations, circuitry, and gives superior performance. All of the equipment shown was formerly in use but scattered in random fashion around our laboratory.

Several innovations were required in the physical layout to make all equipment accessible from the front of the installation. We found that a double rack assembly would fit perfectly into a small area between two built-in consoles. Each rack would mount several pieces of equipment, including a 16" television tuner.

To meet our own requirement for recording and reproduction on disc and tape, we decided to incorporate the following equipment:

1. A preamplifier with five selective inputs and with self-contained variable equalizers.
2. A line amplifier.
3. Two jack panels.
4. A 50 watt recording and playback amplifier.
5. A 10 watt monitor amplifier.
6. A spare record-reproduce amplifier, with built-in dynamic noise suppressor.
7. An FM-AM tuner with built-in audio preamp and equalizers.
8. A 16" television tuner.

Sectional view of the author's recording studio, laboratory, and television viewing center built into the walls of a den.

9. Two speakers on two separate 600 ohm lines.
10. A two-speed tape recorder with monitor.
11. Dual 16" turntables for recording and playback.
12. Volume and power level meter panel.
13. A d.c. supply for meter illumination and certain filaments.
14. Provision for several phonograph pickups of various types.
15. A 3 watt amplifier for the television tuner.

You will note the absence of a conventional mixer panel. This was deemed unnecessary since the preamplifier on hand had adequate provision for the limited amount of mixing that would be required in this particular system.

The Preamp-Equalizer

Our first requirement was satisfied by employing a *McIntosh*, Model AE-2 preamplifier-equalizer control unit. This was originally designed to provide an adequate amount of amplification between five different program

RADIO & TELEVISION NEWS

sources and a recording or reproducing amplifier. Various program circuits are selected by means of a front panel control labeled "Selector." Five input channels are provided. Circuits 1 and 2 receive 40 decibels of amplification, constant from 20 cycles to 20,000 cycles.

Circuits 3 and 4 receive 40 decibels of amplification, constant from 1000 cycles to 20,000 cycles (but increases below 600 or 300 cycles to compensate for the 6 decibel-per-octave recording characteristic). A choice of either turnover frequency (600 or 300 cycles) is selected by a switch on the panel.

Circuit 5 receives 70 decibels of amplification which is constant with respect to frequency. All five circuits are subject to variable amounts of bass and treble boost or bass or treble attenuation. The two controls are non-interacting and provide a boost up to a maximum of 17 db. and attenuation to a maximum of 17 db.

The first two channels are intended to be used between such program sources as crystal microphones or pickups and FM-AM tuners. In order to prevent overloading at the inputs of these two channels, separate potentiometers are provided which may be used to preset the program level in those two circuits.

Circuit 3 presents a 27,000 ohm load and is designed to provide flat frequency response from the high impedance *Pickering* cartridge. Circuit 4 likewise presents a 12,000 ohm load which provides substantially flat response from the *G-E* variable reluctance cartridge. Where circuits 3 and 4 are used with magnetic cartridges of other manufacture, such as the new



A bird's eye view of the two disc recording and playback channels. Ample storage space for the processed transcription discs is provided in the cupboards below.

Audax, the terminating resistance may be removed and the optimum value substituted, as recommended by the manufacturer.

Circuit 5 provides 70 decibels of amplification and loads the program source with $\frac{1}{2}$ megohm resistance shunted by approximately 16 $\mu\text{fd.}$ of capacity. This circuit provides adequate amplification for nearly all high impedance magnetic type microphones.

The two equalizer controls are used to modify the frequency response of the preamp on each of the five program circuits. In the case of circuits

3 and 4, the 6 decibels-per-octave change in amplification below 300 or 600 cycles, may be either increased to 12 decibels-per-octave or reduced to almost a constant amplification with respect to frequency.

It was necessary to modify the output circuit of the preamplifier to meet our own particular requirements. Normally the parallel-connected 12AX7 tube is used in a cathode follower circuit and feeds directly to the power amplifier. We added an output transformer to match the output imped-

(Continued on page 135)

All of the program sources, the metering circuits, and the outputs of the entire system terminate in this jack field.

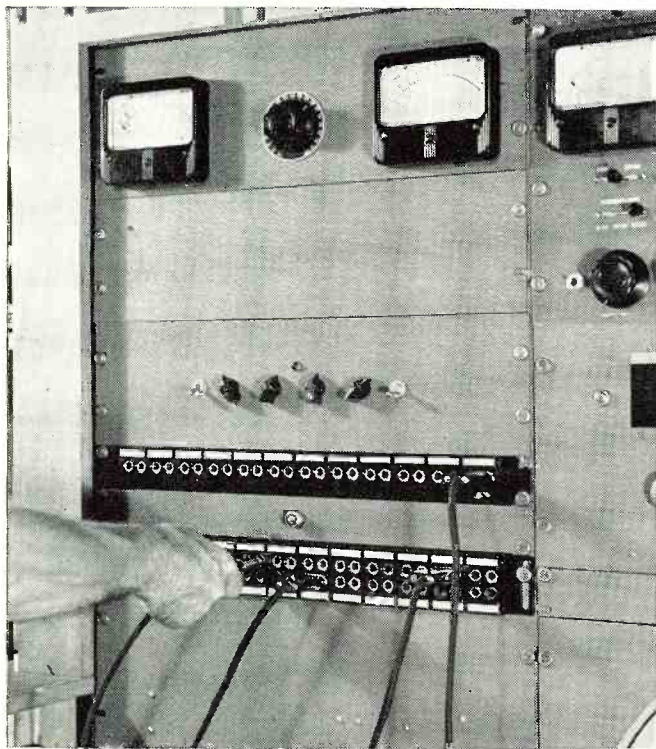

Convenient hinged panels give easy access to the amplifiers used in recording and monitoring the program material.

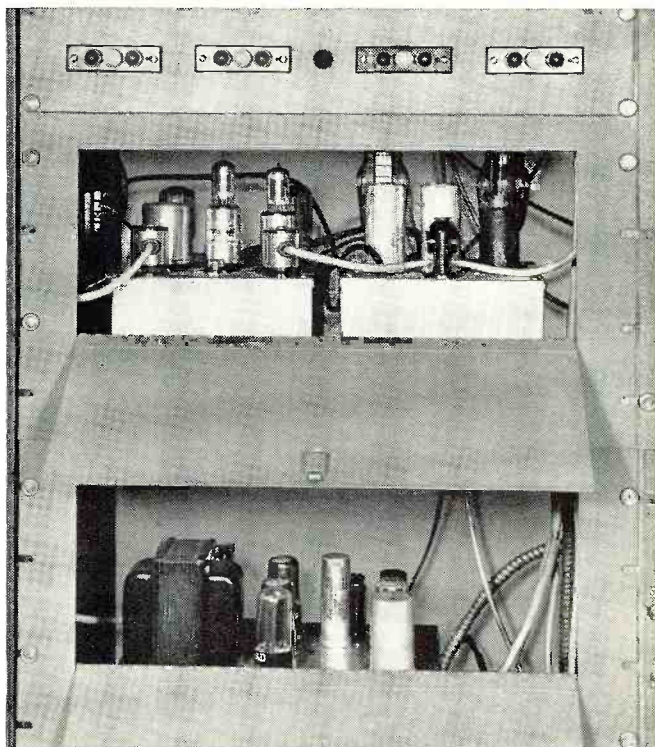



Devotees of high-quality reproduction are buying the individual audio components and housing them in cabinets such as these Jensen "Custom-Mode" units.

How To Judge AUDIO QUALITY

By JOSEPH MARSHALL

In the final analysis, it is the "subjective listening test" which really tells the story.

SO, YOU'VE finished that super-duper high fidelity amplifier and now you want to know how good it really is. You can, and no doubt you do, make some frequency runs and some distortion measurements and perhaps look at some scope patterns. But the proof of the pudding is in the eating and of a high fidelity sound system is in the listening. All authorities agree that in the final analysis it is the "subjective listening tests" which really tell the story. But how do you go about making such tests? What are the criteria for a good amplifier? In other words, you ask: "How do I know when I listen that my amplifier is as good as I hope it is? What do I use for test material? What are the characteristics of a good system? What do I listen for?"

The General Effect

Let's dispose of one thing to begin with, namely: *there is no necessary connection between perfect reproduction and fidelity and the adjectives*

"pleasant and mellow." Much of the confusion in the high-fidelity field results from a tendency on the part of those who have little or no experience with, or knowledge of, music to judge reproduction in terms of the question: Does it sound pleasant or not?

Good music is pleasant, more often than not, but it is not pleasant because the tone is entirely pleasant. There are many elements of great music, played magnificently, which are definitely on the unpleasant side from a tonal standpoint. On the other hand, it is very probable that the tone of a cheap table model radio, operating at low volume levels, with its limited frequency response, masked distortion, and mellow tone, is more pleasing to most ears than the Philharmonic Orchestra in person. In high fidelity reproduction we are not trying to improve on the original material, but merely to recreate it with the greatest faithfulness. So let's start by forgetting those words "pleasant" and "mellow." They do not necessarily apply

to high-fidelity reproduction; and, on the contrary, are often characteristic of systems of low fidelity.

That does not mean that high-fidelity reproduction must be unpleasant. It is true that too often in the past it has been highly unpleasant for the simple reason that inadequate systems have added more unpleasant elements to the original than the ear could tolerate. And this brings us to the first and one of the most important criteria of a great sound system: *The over-all effect must not be painful.*

Great music well played, even the dissonant modern music, is not painful although it may be unpleasant at first hearing. It doesn't actually hurt the ear, produce headaches, uneasiness and nervousness. Bad high-fidelity systems are very painful, *literally* painful. Listened to for long periods they do produce headaches and a squirmy unease, a firm desire to pull the switch and stop the noise.

The term "fatigue factor" is now finding its way into acoustic terminology and refers to this tendency of poor sound systems to cause pain and fatigue in listeners. Fatigue is caused principally by excessive distortion. The lower the distortion, the lower the fatigue factor. Therefore, for the most critical listening test of all, feed your sound system high fidelity program material and keep it going, at a slightly higher than normal volume level, for stretches of 5 or even 10 hours, while you and your family go about your normal business.

If you and your family can stand listening to it many hours at a stretch without getting irritable or headachy, you are on the right track. But if the amplifier does make people irritable, or gives them headaches; if they ask after so long to have it shut off, or simply beat it out of the house, the chances are that it isn't because they don't appreciate the finer things of life, but because your amplifier has too much distortion and too high a fatigue factor.

High Frequency Response

Curiously enough, one of the mistakes designers make when listening to their first high fidelity amplifier, is to confuse distortion with high frequency response. When the new amplifier and speaker begin to emit sounds of indubitably high frequency and a lot of them, the constructor assumes he has achieved a great high frequency response. And so, to be sure, he has; for the distortion would not be so audible if the passband were narrow.

Actually the very fine high-fidelity system, at first hearing, appears to have less high frequency response than the poor system simply because it lacks distortion. And, lacking distortion, it actually has less high frequency amplitude in its output than the poor "high-fidelity" system.

It reproduces the very high frequency tones, but it reproduces them
(Continued on page 171)

A Two-Channel MAGNETIC RECORDING AMPLIFIER

Panel view of home-built amplifier. It can be adapted for public address work.

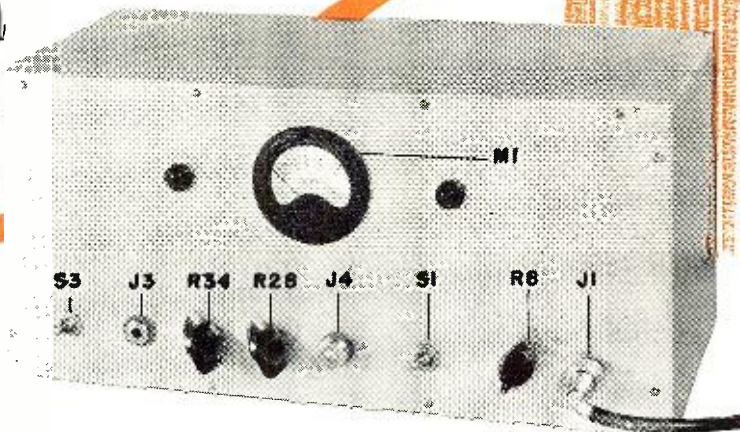

By

LLOYD B. HUST

WITHIN the past few years, magnetic recording has become one of the most popular methods employed in the recording art. At first, this may seem strange in view of the fact that magnetic recording techniques were first explored more than 50 years ago. The recent popularity of magnetic recording has actually been brought about by a number of things. First, and probably foremost, is the technique of recording using a supersonic bias voltage mixed with the signal being recorded. This method of recording virtually eliminates the distortion and high background noise which was typical of early magnetic recorders. Second, the development of high permeability materials for use in magnetic recording heads has done much to raise the standard of such a method. Third, and definitely not the least, is the development of high quality recording materials, both wire and tape.

At the present time there are a number of good magnetic recording accessories on the market—wire and tape chassis as well as various types of recording, playback, and erase heads. However, there are very few experimental amplifiers on the market for magnetic recording.

Most of the tape and wire recorders on the market today are equipped with amplifiers of the "dual type." That is, they have one amplifier which functions as both a recording and playback amplifier. This has several advantages—low cost, compactness, etc., but it lacks the flexibility of a true two-channel amplifier.

The truly "professional" recorders—that is, those used for broadcasting, movie sound recording, etc., use two-channel amplifiers. One big advantage inherent in this type of amplifier is the opportunity it affords for monitor-

Two complete amplifiers on one chassis designed to be used with separate recording and playback heads.

ing the recorded material right from the wire or tape as the case may be. Another advantage with this type of amplifier is the possibility of having one type of equalization for recording and another for playback without the necessity for complicated switching circuits. Also, it becomes unnecessary to bring input and output circuits together in a switch with all the problems of feedback and hum that this practice entails.

The amplifier to be described is es-

EDITOR'S NOTE: The recording and playback heads used were of the high impedance type. Indiana Model TD-704, Shure Model 815, and the head used on the Brush "Soundmirror" were all tried with equally good results. Identical heads were used for both recording and playback.

If desired, low impedance heads can be used with this amplifier. If this is done, the playback head should be fed to the first grid through a 50 ohm-to-grid input transformer. The record head should be fed from the output of the 6SN7 through an output transformer of the correct impedance to match the plate of the 6SN7 to the impedance of the head used. The bias, in this case, would have to come from the low impedance winding on the oscillator coil, and would probably be fed into a tap on the record head winding, depending on the head used.

entially two complete amplifiers mounted on one chassis with one power supply, but otherwise operating independently. One section is designed for recording only and is equipped with the proper equalizing circuits for this function as well as with the bias oscillator necessary for recording. The other section is designed for operation with the "play" head as the input de-

vice. The proper equalizing circuits for this function are provided. The amplifier was designed for use with separate recording and playback heads, but it can be used with a dual purpose head by simply connecting the head to the output of section one for recording and to the input of section two for playing back. For this reason similar connectors were used with the output of the recording amplifier and the input of the playback amplifier.

Switch S_2 has been added to permit the recording channel to be fed into the playback channel if it is so desired. This permits the unit to be used for limited public address work as well as for playing phonograph records.

Although the recording equalizer is not in the circuit when this switch is used, the equalization is so small that the signal is not greatly affected. This switch may be used for monitor purposes when recording on machines using only one head.

The unit was built on a 7" x 14" x 2" chassis with a 7" x 15" metal panel. The panel was given a stippled effect by treating it as follows: First it was rubbed down with steel wool. Then an ordinary pencil was chucked in a drill press with the eraser end down. With the machine running, the pencil eraser was brought into contact with the panel for an instant. The panel was then moved slightly and the operation repeated until the entire area of the panel had been covered. This will work well with either aluminum or steel panels and the result is a pleasing, mar-proof panel which enhances the appearance of the equipment.

The recording channel of this unit utilizes a 6SQ7 preamplifier which is resistance coupled to one section of a 6SL7 electronic mixer. The other section of this tube is connected to a jack which supplies a signal from a phono pickup or from a radio tuner. This circuit makes possible the mixing of the two inputs without the slightest sign of interaction. This mixer stage is then fed to one section of a 6SN7, from there through an equalizing network to the second section of this same

tube from which it is fed through a .5 μ d. condenser and a 25,000 ohm resistor to the recording head. One thing will be apparent from the schematic of this section, i.e., that small values of cathode condensers are used and in the case of one stage, no cathode condenser is used at all. The reason for this is to help pre-emphasize high frequencies, a feature that is necessary for good magnetic recording.

For the recording bias, an oscillator using a 6V6 tube in conjunction with

a Webster-Chicago oscillator coil is connected. The voltage from this oscillator is shunt-fed to the head through a 150 μ d. condenser. It might be well to mention at this point, however, that this condenser, C_{26} , should be chosen to give the best value of bias flux at the recording head, and that its value should be increased if the bias is too low, or should be decreased if the bias is too great. The value is not critical, however, and the value given in the parts list seems to

Schematic diagram of the two-channel recording amplifier. Equalizing networks and bias oscillator are incorporated.

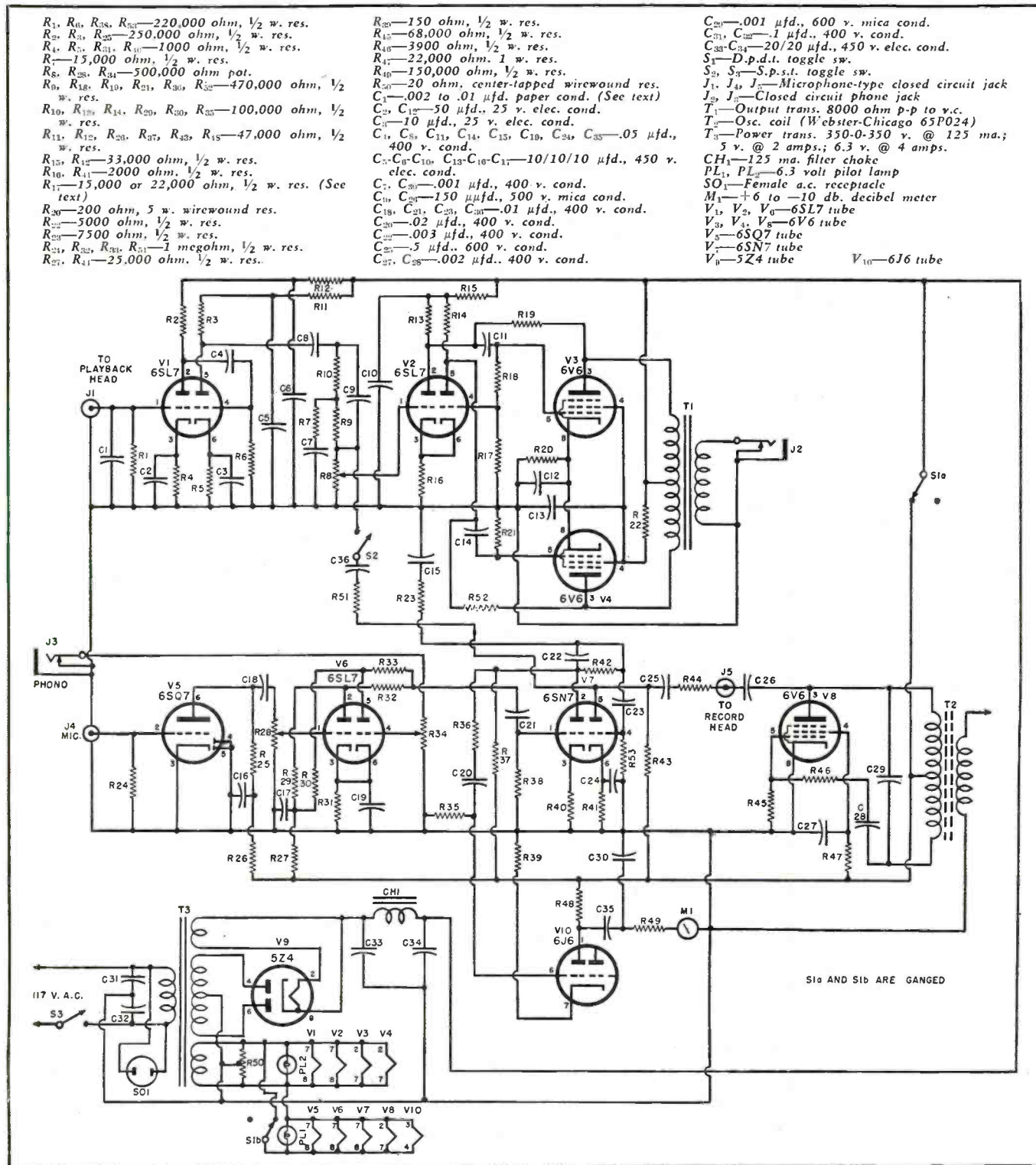

be right for most high impedance heads.

A necessity in any good recording amplifier is a good volume indicator. Since positive results can be had with a meter, the indicator chosen for this amplifier was a small decibel meter. It is easy to read and adjustments can be made for different types of heads or different kinds of tape which may require different recording voltages.

An annoying problem, as far as a volume indicator meter is concerned, is caused by the presence of the supersonic bias voltage in the circuit. Were it not for this voltage, we could simply connect the meter across the output of the amplifier and make the adjustments necessary for indication of proper volume level and that would be that. Not so with supersonic bias in the circuit. This bias voltage energizes the meter and gives a steady reading much higher than the fluctuating reading desired from the audio voltage, hence, we must isolate the audio voltage from the bias voltage.

In this amplifier this is accomplished by the use of a separate output stage for the meter. A 6J6 tube was used for this stage because of its size and because one was on hand. Almost any triode would suffice. This tube was mounted above the chassis in a horizontal position and its grid was energized from the *first* plate of the 6SN7. In this way a minimum of bias voltage reaches the grid. A small amount of this voltage does affect this tube, however, but this is bypassed out of the meter circuit by C_{30} . The resistor R_{30} determines, to some extent, the swing of the needle and its value may be raised or lowered to suit the situation.

The Playback Channel

The playback channel consists of a 6SL7 with the two sections in cascade, giving two stages of amplification. It may be necessary to shield this tube. The output from this tube is fed through an equalizing network to another 6SL7 which is used as a phase inverter feeding the 6V6 output tubes.

In this channel there are a few departures from standard practice which should be explained. First, the condenser, C_1 , across the grid of the pre-amplifier stage is a condenser which should resonate with the head chosen, at some high frequency. This condenser gives the sharp high frequency boost which is required if anything approaching flat response is to be obtained with the amplifier. Its value will depend on the inductance of the head and the frequency at which boost is desired. This value can be found experimentally and the unit chosen should be the one which gives the best high frequency response with the head used. The value will usually be between .002 and .005 μ fd. although it may be as high as .01 μ fd. with some heads. As much as 6 db. boost can be obtained due to this resonating condenser. Another item which will be noticed is the fact that the volume

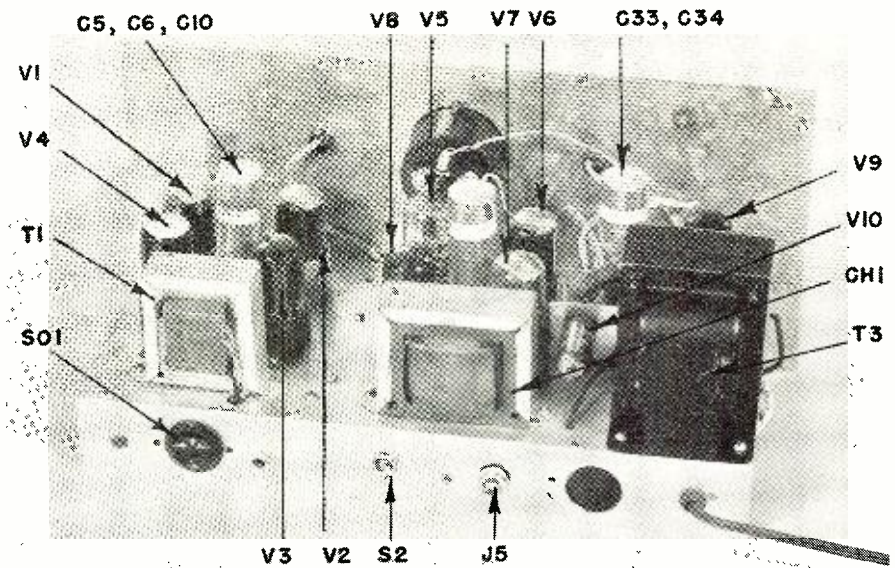

Top chassis view of amplifier shows the careful parts placement required.

control is not in the circuit until the phase inverter stage. This was done solely to minimize hum. The control and the equalizer circuit can introduce hum if they are in a low level stage and for that reason the control was introduced at the input of the phase inverter.

The equalizing portion of this channel other than C_1 is essentially a low boost equalizer and it is made up of R_7 , R_9 , R_{10} and C_7 and C_9 . If greater low boost is desired as it may be with some heads, C_7 can be changed to 50 μ fd. If less boost is required, the value of C_9 can be increased.

Some question may arise in the constructor's mind about the feedback circuit used. Feedback is shown from one plate of the upper 6V6 to its grid. However, as this grid also feeds the other half of the phase inverter, feedback to both tubes is obtained.

If conventional feedback from both plates is desired, the resistor R_{22} shown dotted may be added. This will require the changing of R_{17} to a 22,000 ohm, $\frac{1}{2}$ watt size.

Both of these systems work about the same and the distortion suppression is about the same.

The output jack J_2 is mounted on the rear chassis lip next to SO_1 .

Since hum-free operation of both channels was a prime necessity, pains were taken to minimize hum in every way possible with the exception of the operation of the heaters on d.c. The chassis was not used as a common grounding point, but a bus of #12 wire was run the length of the chassis and was mounted on insulated tie posts. This bus was used as the ground throughout and was connected to the chassis at one point only. Practices vary on the grounding of such a bus, but in this unit it was grounded to the chassis at the point where the center tap of the high voltage winding of the power transformer was brought to ground. All plugs, etc., were insulated from the chassis and panel by the use of fiber washers and *all* grounded points were run to the bus. Any shielded wire used—a minimum

(Continued on page 143)

Under chassis view of the magnetic recording amplifier. A common ground bus was used, being connected to the chassis at only one point where the center tap of the high voltage winding of transformer, T_3 , was grounded.

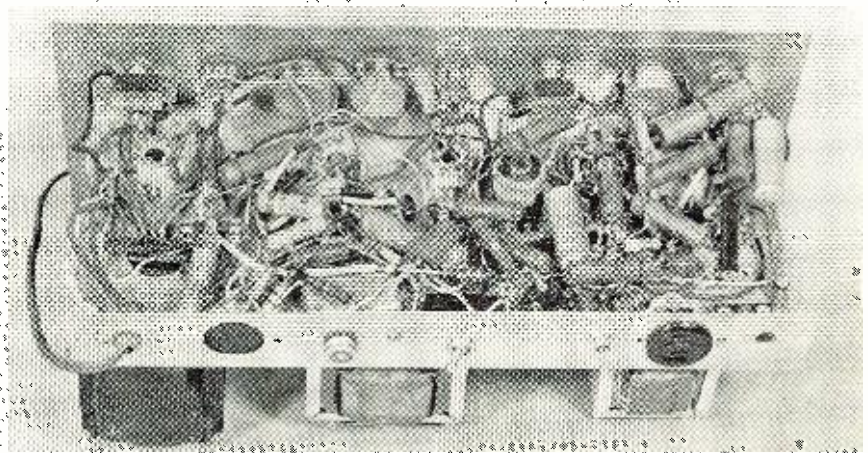

A Self-Equalizing PREAMP

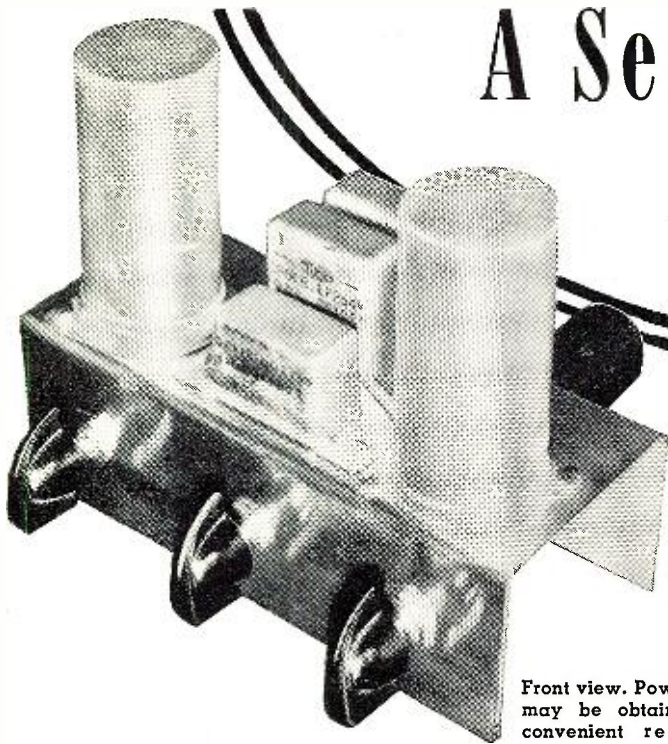

Front view. Power for this unit may be obtained from any convenient remote supply.

By

J. CARLISLE HOADLEY*

THE amplifier design trend today is toward providing a power amplifier section with heavy negative feedback and a frequency characteristic which is flat from some low frequency to well beyond audibility. These amplifiers approach theoretical perfection in linear amplification but fall far short of perfection in actually providing high fidelity results when called upon to drive a loudspeaker from a signal source. The fault does not lie in the amplifier, however, but in the loudspeaker's deficiencies in certain frequency ranges, and in the human hearing mechanism.

The loudspeaker is capable of efficient radiation of sound down to a frequency where the physical length of the sound wave is in the same order of magnitude as the diameter of the speaker's cone. Below this frequency, the speaker has successively greater difficulty in radiating sufficient low frequency energy, due to poor coupling to the air.

This situation is modified somewhat by placing the loudspeaker in an enclosure which, by one device or another, attempts to match the acoustic impedance of the speaker to the acoustic impedance of a room.

It is possible, at relatively low sound levels, to electrically equalize a speaker system so that it will reproduce frequencies as low as 40 c.p.s. at the same intensity as 1000 c.p.s. This equalization can be provided by the usual bass boosting circuit, but will still be inadequate. At normal listening levels, the low frequencies will still seem weak or non-existent.

The human ear has several characteristic peculiarities. Among these

is the "Fletcher-Munson effect." This effect is characterized by a change in sensitivity of the ear to frequency extremes with a change in sound level. It is most pronounced at the low frequencies, *i.e.*, the ear sensitivity falls off quite rapidly as the sound level is reduced below the 100 db. level. There is a similar but smaller change in ear sensitivity at the frequencies above 8000 cycles per second. In listening to natural sound sources, this "Fletcher-Munson effect" is of no consequence, since we have interpreted sounds modified by this frequency characteristic since birth.

For instance, as we move closer to an orchestra, the level in db. presented to our ear drums increases. Normal hearing response is very nearly flat at a level of approximately 100 db. As a listener moves away from the musical sound source, however, the lower frequencies attenuate more rapidly than those of the middle range. Therefore, by sitting at the rear of an auditorium during a concert, the listener does not receive the same balance of high and low frequencies that he would experience if sitting in the front row.

When the orchestra is "picked up" with a microphone for radio broadcasting, the microphone is placed near the orchestra to obtain a good acoustic signal-to-noise ratio. In his home, then, the listener would have to operate his reproducing system at the same level (approximately 100 db.) as the orchestra for a natural reproduction.

It is when the normal level of the

* Audio Sub Section Head, Radio and Communications Section, Electronics Test Division, Naval Air Test Center, Patuxent River, Maryland.

This unique circuit automatically compensates for "Fletcher-Munson" effect. Reproduced sound will seem natural irrespective of output level.

original sound is changed that the trouble begins. When listening to reproduced music at the 100 db. level where the human ear has a flat frequency characteristic, the music will sound perfectly normal (presupposing a flat audio system). Since the sound level produced by a 100 piece orchestra (100 db.) would be too loud for the average living room, there will be a desire to lower the volume. The volume is reduced, therefore, until the sound is reproduced at a level of 70 db. As far as the ear is concerned, the listener has moved several hundred feet from the sound source, and the reproduced sound has exactly the same character as if he had done just that.

Suppose our hypothetical listener did not wish to move away from the orchestra, but had intended to have the orchestra play at a level more consistent with his mood and place of listening. He will, therefore, instinctively reach for a bass boost control to bring himself closer to the music. When the bass has been boosted, the orchestra will seem close but playing softly. If music is required as a background for conversation, we would naturally have a desire to reduce the low frequencies to a point where the music seems to come from a distance.

This interesting ear characteristic and various listener preferences for different listening levels are responsible for the "tone control" circuits in amplifiers and radio receivers.

An understanding of why we want tone control is necessary for intelligent design of tone equalizer circuits. It would be a great convenience if the listener could concentrate on enjoying the music rather than laboriously adjusting and re-adjusting the tone control circuits with each change of the volume control.

There are several ways to change the response of the audio system with a change in loudness level. Some have been described in this magazine, and there is at least one such control commercially available. The idea is not new.

RADIO & TELEVISION NEWS

The equalizing amplifier to be described is a somewhat different approach to the problem and has several refinements not found in some other systems. The curves in Fig. 2 show the amount of correction required for the low frequencies for the levels from 60 db. to 100 db. The 60 db. level is lower than anyone would run an audio system, and is too low a level for listening to a play or a news report if the listener is ten or twelve feet from the speaker. The noise level in an average living room is approximately 55 db. (windows open, summer).

The 100 db. level is as loud as a full symphony orchestra with the listener in the position of the conductor. These corrections are based on an average listener. The individual's ears may vary considerably, as well as his taste. The loudspeaker, audio system, and source of the sound will also modify the amount of equalization, i.e., an old 78 r.p.m. recording might need more boosting than a live FM program. Controls are, therefore, provided to compensate for the individual situation, and, then, the unit automatically varies the response as the volume control is changed.

The circuit diagram appears in Fig. 1. The unit consists of a two-stage pentode amplifier. Pentodes were used because of their high gain and lack of "Miller effect." Since the two feedback loops are each applied around only one stage, each pentode is necessary to provide sufficient gain for the required equalization. At low levels, the pentode is virtually distortionless and the excellent shielding afforded by the metal tube shells helps to keep hum at a minimum. The 6J7 was used as an input tube because of the grid being well isolated from the heaters.

One of the feedback loops is applied from the plate of the 6SJ7 tube to the junction of the lower end of the volume control and a resistor between this point and ground. This circuit constitutes a feedback loop where the amount of feedback is variable depending on the setting of the volume control.

When the volume control is in the "Max." position, there is a high resistance between the feedback circuit and the tube's grid, and only a small amount of feedback is applied around the tube. As the volume control is turned toward the "Off" position, it successively reduces the resistance in the feedback circuit. At the minimum position there is no resistance between the feedback circuit and maximum feedback is obtained.

A reactive network is included in the feedback loop so that the low frequencies are not fed back as much as the higher ones. The low frequency crossover point is about 500 cycles per second. The high frequencies are also varied slightly at a crossover of approximately 8000 cycles per second.

The circuit is, in effect, one where the gain at different frequencies is varied at different rates as the volume

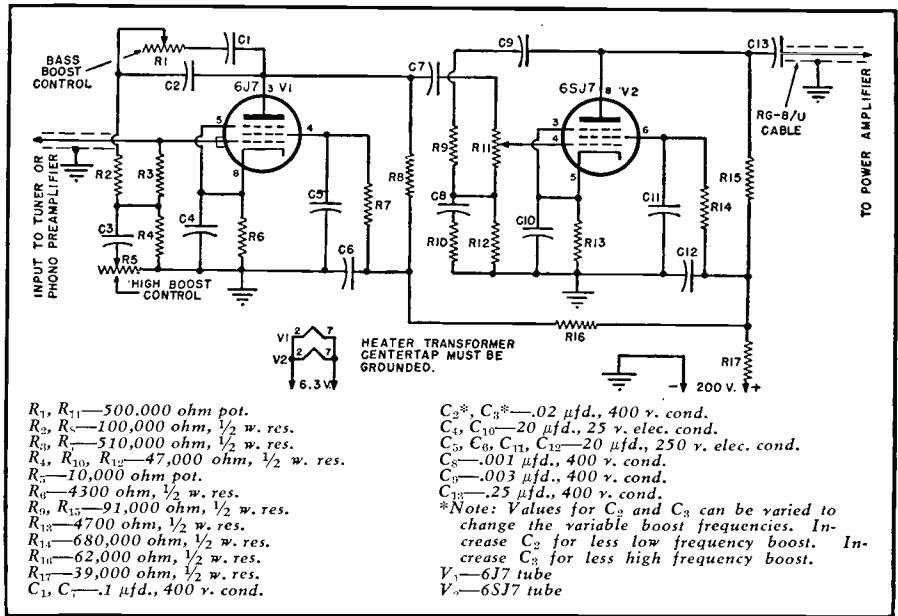

Fig. 1. Complete circuit diagram. Tone controls provide a maximum of 10 db. boost.

level is changed. The first stage has a similar feedback loop without a volume control in its grid circuit. This feedback loop contains a variable network which allows the high and low frequency equalization to be changed by means of panel controls.

The extremes of equalization at the high and low frequencies are shown in the curve, Fig. 3. These variable controls allow the operator to set the response to his taste for different program material, speaker deficiencies, speaker location, and his particular ear peculiarities.

If the builder wishes to change the frequency at which the controls will boost the low frequencies, the .02 μ d. condenser (C_2) may be increased for a lower frequency boost and decreased to move the boost to a higher frequency. The high frequency boost can be likewise changed by increasing the value of the .02 μ d. condenser (C_3) for a lower high frequency boost and decreasing its value to move the boost to a higher frequency. After these variable controls are set, one can change the volume control setting and the reproduced sound will seem natural at all levels.

The unit was constructed on a "U"-shaped chassis, which affords good shielding for the various parts. It is wired point-to-point to keep the leads short. The heater wiring must be twisted and kept as far from the grid and plate pins of the tubes as possible.

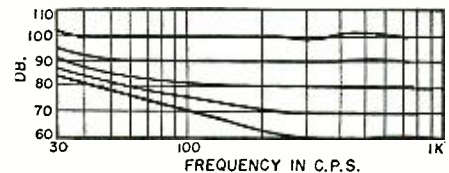

Fig. 2. Required equalization to compensate for deficiencies of the human ear at low frequencies with changes in output level.

A ground bus is used and is strongly recommended. DO NOT try to use a common wire in the power cable for 6.3v. and "B minus," or incurable hum will result. The heaters must have their center taps grounded rather than one side.

All grid leads should be shielded, as should the input and output cables. RG-8-U coaxial cable is a small, low capacity shielded cable intended for r.f. use. It is recommended for audio use because of its excellent insulation, low capacity, and small size.

The unit is readily mounted by means of the volume control nuts. It is connected to the main amplifier by cables containing the audio output of the unit and the power for the tubes. Most amplifiers will stand the additional drain of 6.3v. at 0.6 amp. and 200v. at 12 ma.

This remote location of the unit makes for convenience of mounting and removes the unit from troublesome hum fields. The input is suitable. (Continued on page 156)

Fig. 3. Response curves show high and low boost range at various control settings.

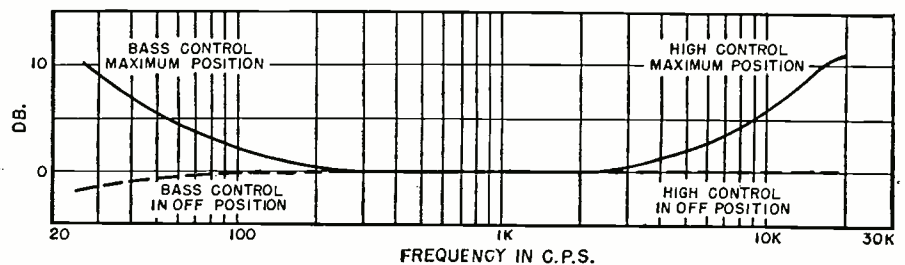

The "AUDITIONER"

HERE has always been a scattered and unchartered group of hobbyists called "Hi-Fi Enthusiasts." These are people who wanted to hear good music at home, but couldn't get it from their "store bought'n" radio sets or record players. They felt, and rightly so, that each of the components of a system—the pickup and cartridge, the tuner, the amplifier, the speaker, the speaker enclosure—required individual design and proper construction to be good. Together these audio components could be combined into a system that would provide the wide frequency response and the low distortion required for proper reproduction of the original music. The hobbyists, at first, consisted of those technically qualified to build whichever components of a system could be built—the amplifier, the tuner, the speaker enclosure, and other cabinet work. But there are music lovers everywhere, and this small group of Hi-Fi enthusiasts was destined to grow. Increased demand for the components made it worthwhile for many manufacturers to come out with good units that the music lover, with even an average budget, could afford. The advent of a low priced variable reluctance cartridge probably gave this hobby its greatest impetus.

The number of manufacturers and the variety of models of amplifiers, tuners, etc., etc., grew in number until the choice of components was wide and varied. Soon the question of "what to buy?" became paramount. Radio parts and equipment distributors became the logical sales outlets for such components. They provided detailed catalogue descriptions based on manufacturers' literature and their own observations. An honest report of the technical specs made comparisons fairly easy. The high-fidelity fan usually based his selection of components on the data supplied by distributors' catalogues and literature, on information in radio and consumer publications, and by the limitations of his own pocketbook. Many buyers, however, began to ask for listening tests of various combinations. Sometimes they traveled for hundreds of miles to the nearest distributor in order to hear for themselves how a particular setup sounded.

Allied Radio was one of the first to feel the demand for a listening test. Our first equipment to facilitate comparisons consisted of a standard relay rack patch panel. Cords with dual plugs permitted us to "patch in" var-

Closeup of "Hi-Fi Auditor." Two dual-speed professional turntables and four pickups are used to demonstrate relative qualities of cartridges.

By
L. M. DEZETTEL
Allied Radio Corp.

Audio enthusiasts can select their custom equipment from the 371,293 possible combinations of amplifiers, pickups, tuners, etc. connected to the test console.

ious components into a typical system. This procedure was slow and not fully flexible. We immediately began to design and custom-build a control console with push-button switching to provide a completely flexible system for instantaneously interconnecting any component with any other.

The "Hi-Fi Auditor" installed in Allied's high fidelity sound studio consists of a specially-built metal sloping panel console cabinet. Rows of push-buttons on the sloping front panel operate multi-contact switches. Each row is assigned to one component type—one row for pickups, one for pre-amplifiers, one for tuners, etc. A center panel incorporates a system of lights behind translucent name plates. There is a light for every piece of equipment, identifying for the listener

Equalizing network used to correct for the loss of high frequencies due to interlead capacitance. Value of resistor R is fixed for a given line length, 10,000 ohms for 15 feet or 22,000 ohms for 30 feet.

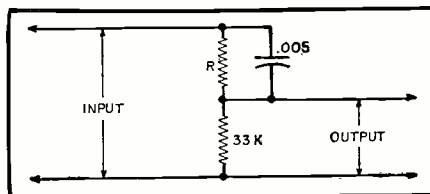

the units in the hookup. The switch buttons also carry the brandnames of the equipment. The table part of the console is a "sunken garden" arrangement of two professional turntables and four pickups, two for each turntable.

Before going into detail about the console, or "Auditioner" as we call it, let's consider the over-all demonstration setup. The console and equipment to be demonstrated are set up in a room especially designed to give a "living room" atmosphere and living room acoustics. A glass panelled door and a glass "picture window" are included to simulate the average amount of glass that might be found in the average home living room of the same size. A scattering of drapes over the picture window and other parts of the striated plywood panel walls, a carpeted floor, and a plain plastered ceiling give about the same reverberation time that would be encountered in the average home. A more ideal reverberation time could have been provided but average living rooms do not have ideal acoustical conditions. We did not want to mislead the listener with a demonstration that would not be duplicated when the equipment he purchased was operated in his own home.

Shelves of amplifiers and some tun-
RADIO & TELEVISION NEWS

ers are installed near the console. Typical complete systems in cabinets, and a host of speakers in enclosures are located around the room. A comfortable divan, modern table, floor and table lamps are used to enhance the living room atmosphere.

A lot of effort, thought, and technical discussions preceded the final design of the "Hi-Fi Auditorium." The block diagram indicates the essential parts of the system. Three electrically and magnetically separated metal channels or ducts carry the connectors and cables from the components around the room to the console. They are grounded together at only one point in their entire lengths. The separation prevents hum pickup or oscillation by magnetic induction, and the single ground point eliminates "ground loops." One channel carries a.c. outlets. One channel carries all cables to the speakers, all at 16 ohms. The other channel carries all low level lines, at 10,000 ohms. We arbitrarily called these 10,000 ohm lines because the output of magnetic pickups, pre-amplifiers, and tuners (these outputs were from triode plates or cathode followers) were at about this impedance. There are 25 speaker sockets and 85 low-level (10,000 ohm) sockets, all of the two contact type, around the walls. All low-level cables are single-conductor, shielded. While the outer shields of the cables are also the ground returns, they are not tied together except at *one* point—at the console. Separate terminal boxes for the speaker leads and for the low-level leads are flush-mounted in the wall near the switching console. From these, cable bundles lead to the console through multi-contact AN plugs. Behind the AN sockets are 3-screw-per-cable terminals. These are used for the equalizing networks. These networks are designed to provide a high frequency rise to compensate for the loss of high frequencies because of cable capacity.

There are 6 rows of push-button switches, each row with 13 buttons. Each row handles a different type of

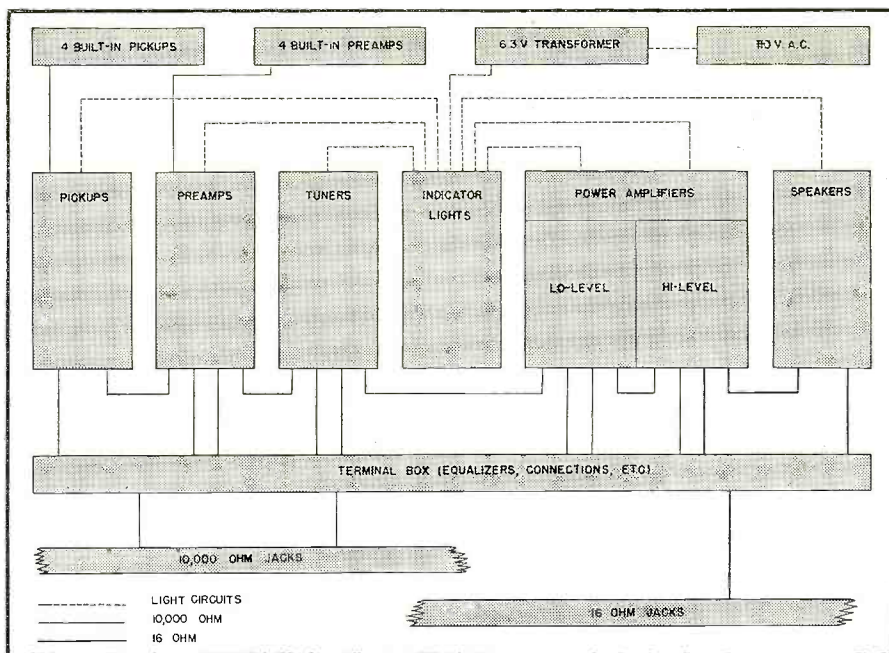

Block diagram showing the essential parts of the audio test console setup.

component, except that two rows are used for amplifiers. There are 371,293 possible setup combinations with this system! The switch contacts are made of solid silver alloy for long life and low resistance. There are 24 contacts per button. A closed circuit affair is used, with each component "cut into" the line. The first row of switches selects the desired pickup, the output of which is fed to the second row of switches. The second row selects the preamplifier, cutting the pickup out-

put into the input of the preamplifier, and feeding the output of the preamplifier on to the next row, which switches tuners. The bottom button of each row (except pickups and speakers) is a "through" button for feeding the signal onto the next row, without using a component from that row. Thus, a pickup signal may be fed straight through to a tuner or still farther down the line to an amplifier. Many amplifiers have high-gain, equal-

(Continued on page 112)

View of the rack which houses amplifiers and tuners used in the sound demonstrations. Because of the flexibility of the test setup new units can be substituted for older models.

Closeup view of the push-button controls. The buttons at the right select various components for demonstration. By merely pushing a button the desired equipment is brought into operation. Lights behind the name plates at the left indicate which unit is in use.

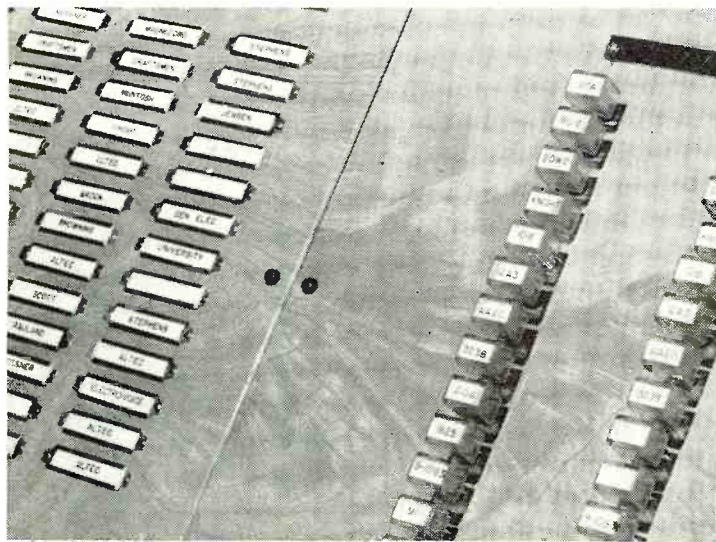

By
J. N. A. HAWKINS

**Modern version of a 1938 design
providing 96 db. and 10 watts.**



Front panel view of the home-built, general purpose amplifier unit.

A Flexible General Purpose AMPLIFIER

THE trend in some manufactured amplifiers has been toward lowered costs at a noticeable sacrifice of performance and flexibility. It is getting rather difficult to find a high quality 10 watt amplifier with enough gain to allow good variable equalization, working from a source like a variable reluctance pickup. If low cost is a requirement the problem of finding a satisfactory amplifier package is multiplied. One answer to this problem is to build a Chinese copy of an outstandingly successful amplifier which has been thoroughly "exercised."

The general purpose amplifier shown in the accompanying diagrams represents a series of progressive improvements over its original ancestor, which was an amplifier designed by George Downs in 1938 to test and demonstrate the early *Miller* lightweight pickup and the early *Lansing* two-way theater horn systems. Cary, Howard, Gilbert, Kelly, Hisserich, Brettell, and others have all contributed ideas to its development over the years and particular credit must be given

to M. O. Kappler for the particular phase inverter used in the present version. Countless other commercial and amateur amplifiers have stemmed from the original Downs ancestor but many of them got lost because of trouble with the three-stage negative feedback. Those of us who have achieved success with this basic design agree that the only source of possible trouble is in the use of an unbalanced phase inverter and/or the use of a low grade output transformer. Many manufacturers of p.a. and b.c. studio equipment have built and sold various versions of this basic unit only to withdraw it from the market after six months or so. The explanation, in most cases, was that the early serial numbers worked fine but the later production runs were touchy and might oscillate, or sing, if the load was removed or tubes aged. In every case the cause could be traced to substitution of a lower priced output transformer or circuit simplification in the phase inverter, as compared with the original model. A lot of "ragged edge" feedback amplifiers will work pretty well as long as the

load resistance is connected and as long as the tubes maintain their rated G_m . That is one of the beauties of feedback. However, it takes good design and a well built output transformer to operate well at non-standard line voltages, flat tubes, unbalanced tubes, and a highly reactive load like a speaker whose field has deteriorated.

One test of good phase-inverter and output transformer performance is to measure the maximum allowable feedback, before singing occurs, with a resistance termination on the output. In this amplifier singing occurs at about 30 db. of feedback (1000 cycles) terminated, with about 26 db. as the maximum for the unterminated condition. Ordinarily, good design suggests that the feedback be set at least 6 db. under the singing point terminated, which implies that no value of reactive load impedance can then cause singing. Actually, one can have too much feedback because only a very few measurement amplifiers need more stability than can be obtained with about 16 db. of feedback. With the constants shown, this amplifier has 17.6 db. of feedback, when working into a resistance termination. Working into an average 16 ohm speaker voice coil the feedback differed from the resistance termination figure by only a few tenths of a db. The feedback could be increased to 24 db. if desired, but no measurable improvement in frequency response nor intermodulation distortion resulted so there was no point in throwing away the 6 db. of net gain involved just to be able to say that the unit had 24 db. of feedback.

Circuit Details

The amplifier has two input circuits so that sound sources of about 30 db. difference in 1000 cycle output can be handled without having to locate a gain control in a low level grid circuit. Actually, the high gain input was designed and equalized for a variable reluctance pickup, with the lower gain input designed for a crystal pickup. This feature is growing in popularity as critical record enthusiasts are indicating a preference for the variable reluctance pickup for 78 and 33 r.p.m. discs, with a good crystal the choice for the 45 r.p.m. discs. This fits in rather nicely with the belief that while there are several good combination 78 and 33 r.p.m. record changing mechanisms plus several good single speed 45 r.p.m. changers there does not

seem to be a good three speed changer mechanism available that is completely happy at all three speeds and under all conditions of disc loading. Thus the high gain input gives a net corrected gain of 96 db. to the output terminals, while the low gain input shows a net gain of 70 db. Some thought was given to a d.c. filament supply but it will be found that turntable rumble will usually be more bothersome than the heater hum with the 60 db. volume range obtainable from this amplifier.

The preamplifier circuit is rather conventional except for the two-stage feedback whose purpose is fixed equalization and noise reduction. The feedback also acts to reduce the source impedance of the plate circuit of the second preamp stage and to keep it constant and independent of the tube aging, which would adversely affect the stability of the variable equalizer which follows the two-stage preamplifier. This particular equalizer is simple and effective. It allows separate adjustment of the low and high ends with 600 cycles kept constant. The 60 cycles can be raised 12 and cut 22 db., while 6000 cycles can be raised 12 db. and cut 18 db.

Any discussion of the theory of equalization will automatically produce a storm of mail for any technical writer so this one will merely say that after 20 odd years of building them, bearing with them, and burying them, I like the axis to bend up and down at 600 cycles, the geometric mean of the high fidelity speech band. I also like 60 and 6000 cycles as the design points for a combination equalizer and band limiting filter for music played at normal home volume. So you don't agree with me?—OK, so keep the iron hot and the CR box handy but the circuit and equalizer coil is a very good deal for a starter. This equalizer circuit has low insertion loss, being a feedback equalizer on the second preamp plate-cathode circuit, and has negligible transient and amplitude distortion. The A-74J has 70 db. of shielding, a very important item where the coil is followed by this much gain.

At the volume control the amplifier divides into what amounts to two parts. The first half is the three-stage preamp and equalizer followed by a high quality bridging amplifier with three-stage feedback giving exceptionally low noise and distortion. An extra input at the bridging amplifier input might be handy for program material that does not require variable equalization. (Is there any such program material?)

The first stage of the bridging amplifier is a rather conventional 6SJ7 stage with two points of interest. Note that the feedback from the voice coil winding (properly phased) is applied to the cathode tap and further note that there is no blocking condenser between the 6SJ7 plate and the first grid of the 6SN7 phase inverter. This d.c. coupling is very important in re-

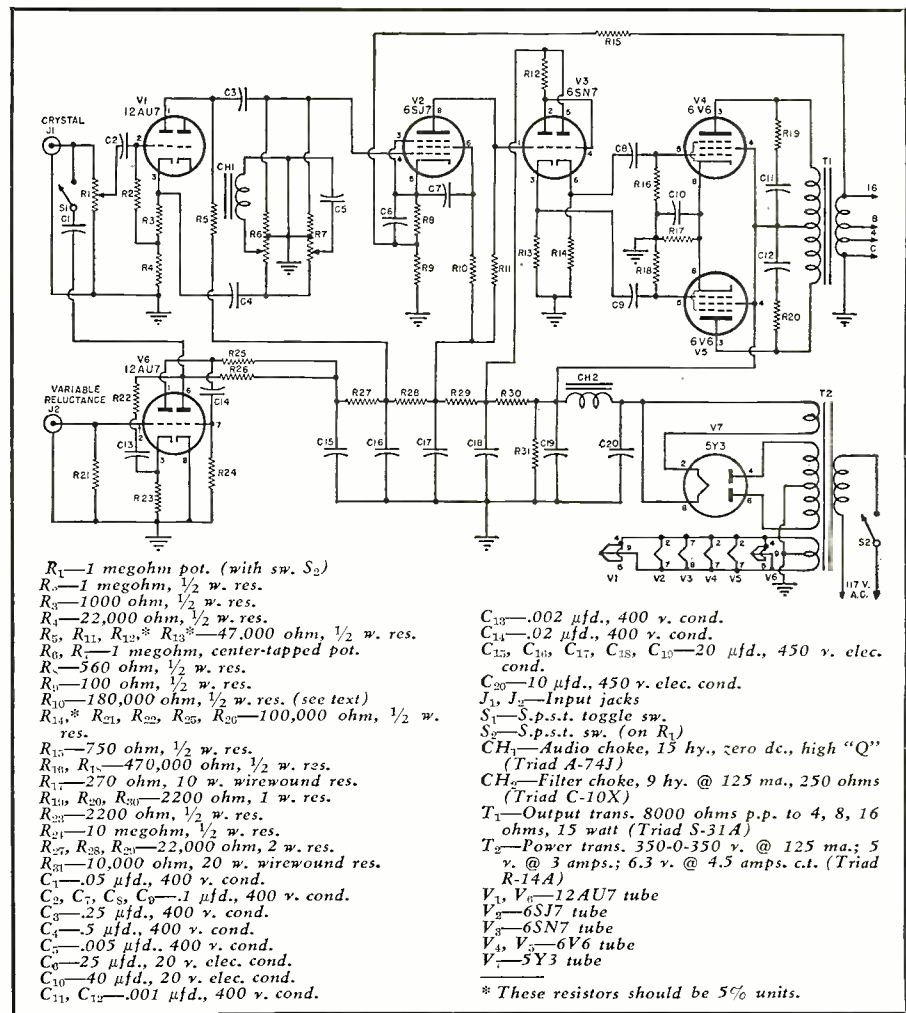

Three feedback loops, d.c. coupling to and within a radical phase inverter, and wide-range variable equalization are featured in this new general-purpose amplifier design.

ducing the low frequency phase shift of the amplifier, which allows maximum feedback without low frequency motorboating. (High frequency phase shift is neutralized by the RC network across the primary of the output transformer.)

There is one semi-critical adjustment in the 6SJ7 stage and it is the only balance adjustment in the whole

amplifier. The 180,000 ohm screen dropping resistor has to be trimmed to adjust the bias on the phase inverter. The bias on both halves of the 6SN7 is adjusted by means of the screen voltage of the 6SJ7. This adjustment does not have too much effect on the balance of the 6SN7 Kappeler phase inverter but it sets the overload point and source resistance

Equalization curves showing available boost and cut in the new feedback equalizer which is characterized by wide range and low insertion loss.

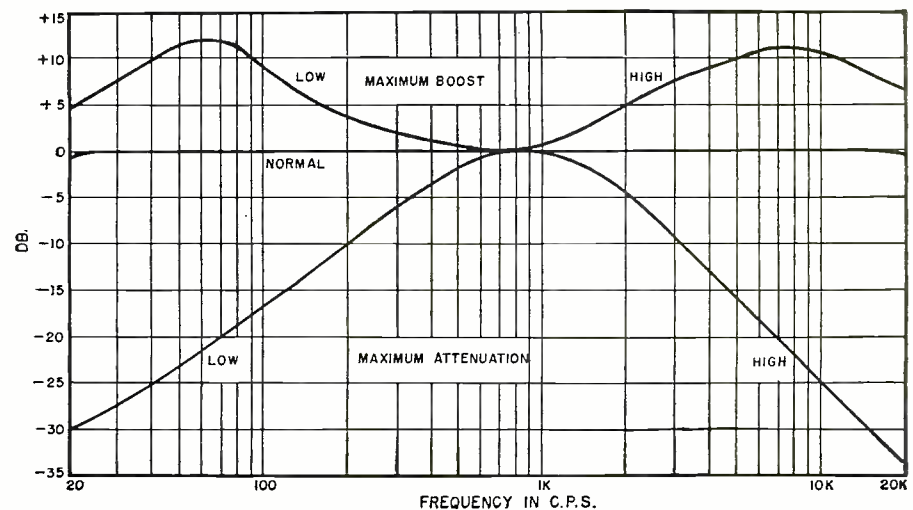

of the two halves of the 6SN7 output circuit for the most graceful overload curve. This results in low, even-order harmonics even well into overload. This amplifier can be operated 3 to 5 db. higher than amplifiers of similar power rating because of the graceful way it slides into overload, thus taking the curse off the occasional high level peaks that sneak through.

The Kappler phase inverter is interesting because of its direct coupled input and interstage circuits. The elimination of coupling condensers is extremely important in stable feedback amplifiers. In fact, it is coupling reactances, such as blocking condensers and transformers, which limit feedback and not the number of vacuum tube stages within the feedback loop. In this three-stage bridging amplifier the two blocking condensers between the cathodes of the 6SN7 phase inverter and the grids of the 6V6 power amplifier are substantially in parallel as far as their contribution to phase shift and singing are concerned. Thus, this bridging section might be thought to include one blocking condenser and one transformer in the feedback loop, a feature which provides great stability against motor-boating and high frequency oscillation.

By driving the 6V6 grids from low impedance cathodes of the preceding phase inverter stage the exciting voltage comes from a source of good voltage regulation so that the output grids can go slightly positive on level peaks without excessive peak clipping and consequent high order distortion.

The output circuit is conventional except that a phase correcting network is tied across the primary of the *Triad* S-31A output transformer. If any other output transformer is substituted a different phase shift net-

work will be necessary. Many builders may infer that such phase shift networks are undesirable and may point out that their particular amplifiers need no phase correcting networks. My question to them would be, "Does *your* amplifier put 30 db. of feedback around three stages without oscillation?" This S-31A seems to have much better than average balance and lower leakage reactance than many output transformers selling for several times the price. The phase shift network might be eliminated by using the *Triad* HS-81 which has less high frequency phase shift, due to materially lower leakage reactance, and the extra octave of response is attractive to those with big horn systems.

The primary winding of the output transformer should be reversed if the amplifier sings, as one polarity of feedback is positive while the proper polarity acts to reduce the gross gain of the amplifier.

The screen voltage of the 6SJ7 stage should be set with a cathode-ray scope measuring the tone amplitude on each 6V6 grid in succession. The proper screen voltage setting is that which produces equal voltage just below the 6V6 grid current point.

The three phase inverter resistors of 47,000, 47,000, and 100,000 should be within 5% of the specified value. All the others can be the usual 10% to 20% tolerance. The plate supply voltage to the 6V6's is 275 volts and they operate as a relaxed class A, which is the most economical compromise for production tubes.

Conclusion

Under most home listening conditions the average audio power used is somewhere between one hundred and five hundred milliwatts.

On selections of great dynamic range, however, the peak passages may require several watts power. If the initial level is high, these peaks may well cause objectionable distortion due to overloading of the amplifier.

Many otherwise excellent amplifiers have a sharp rise in the distortion percentage when the rated output of the amplifier is exceeded.

As this amplifier has a very gradual increase in distortion, even above its rated output, it is capable of handling peak passages requiring great power without the distortion level becoming objectionable.

An often overlooked source of distortion is that caused by inferior speakers or speakers that are operated beyond their linear operating point.

Many of the low cost speakers will give excellent performance at low levels, but when their rated output is approached, the distortion becomes objectionable. Too often, this distortion is charged to the amplifier.

It would probably be well, before condemning an amplifier for poor performance, to make some further checks using speakers of known high quality. In this manner the defect may be easily localized.

This amplifier was designed to give about 10 watts without strain. The 0.3% amplitude distortion point is about 3 watts from 35 to 15,000 cycles. At 1% distortion the power output is 10 watts, from 35 to 15,000 cycles. At 5% distortion the power output is about 15 watts.

Much thought was given to the 6L6G vs. the 6V6GT for the output stage. The 6V6GT is made in vastly larger quantities than the 6L6G. It seems to suffer less from the annoying habit of periodically depositing active cathode material on the control grid, with consequent primary emission from the hot control grid which produces a very bothersome high order distortion.

Also it was felt that very few home horn systems are so inefficient that a good ten watt amplifier won't provide a good 10 db. of volume leeway in order to show the neighbors what you can do if you try. Actually, many music friends like to insert a 2 to 4 db. pad between the amplifier and the horn system so that the amplifier can pretend it is working into a gain set, and also so that the horn system can pretend it is being fed from Boulder Dam. A 2 db. pad in the output of this amplifier will have no noticeable effect on volume but may smooth out a dividing network so that it begins to operate as its designer hoped it might. This pad will also improve the volume range if you need another excuse to help justify its use.

When you have this amplifier working you can know that it is not a one man job dreamed up in a week to fit a particular chassis but represents 12 years of continuing development by top sound engineers working in a dozen different laboratories. —30—

Under chassis view of the general-purpose amplifier showing the simplicity of wiring.

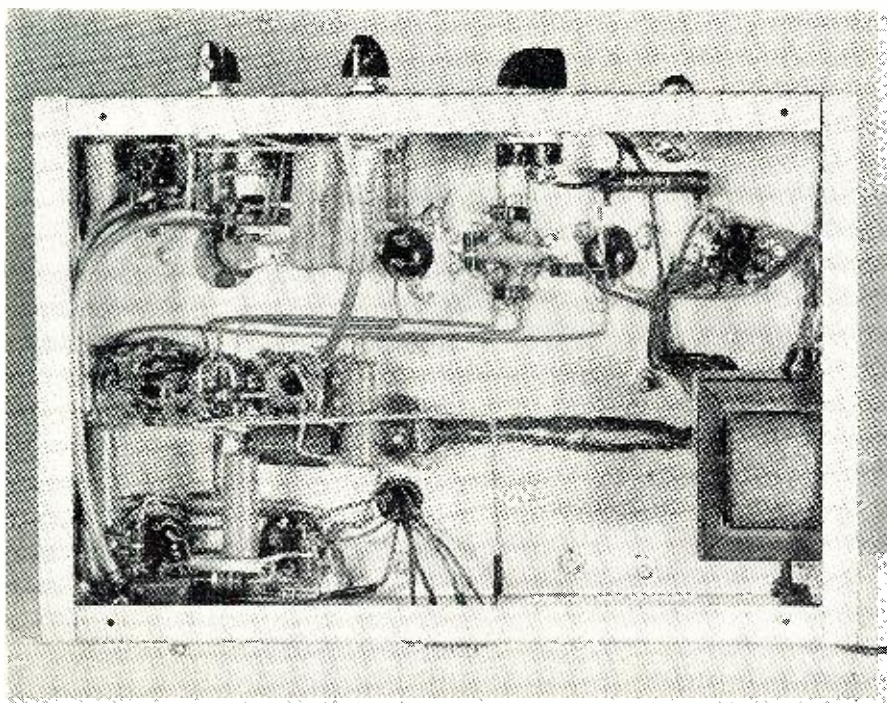

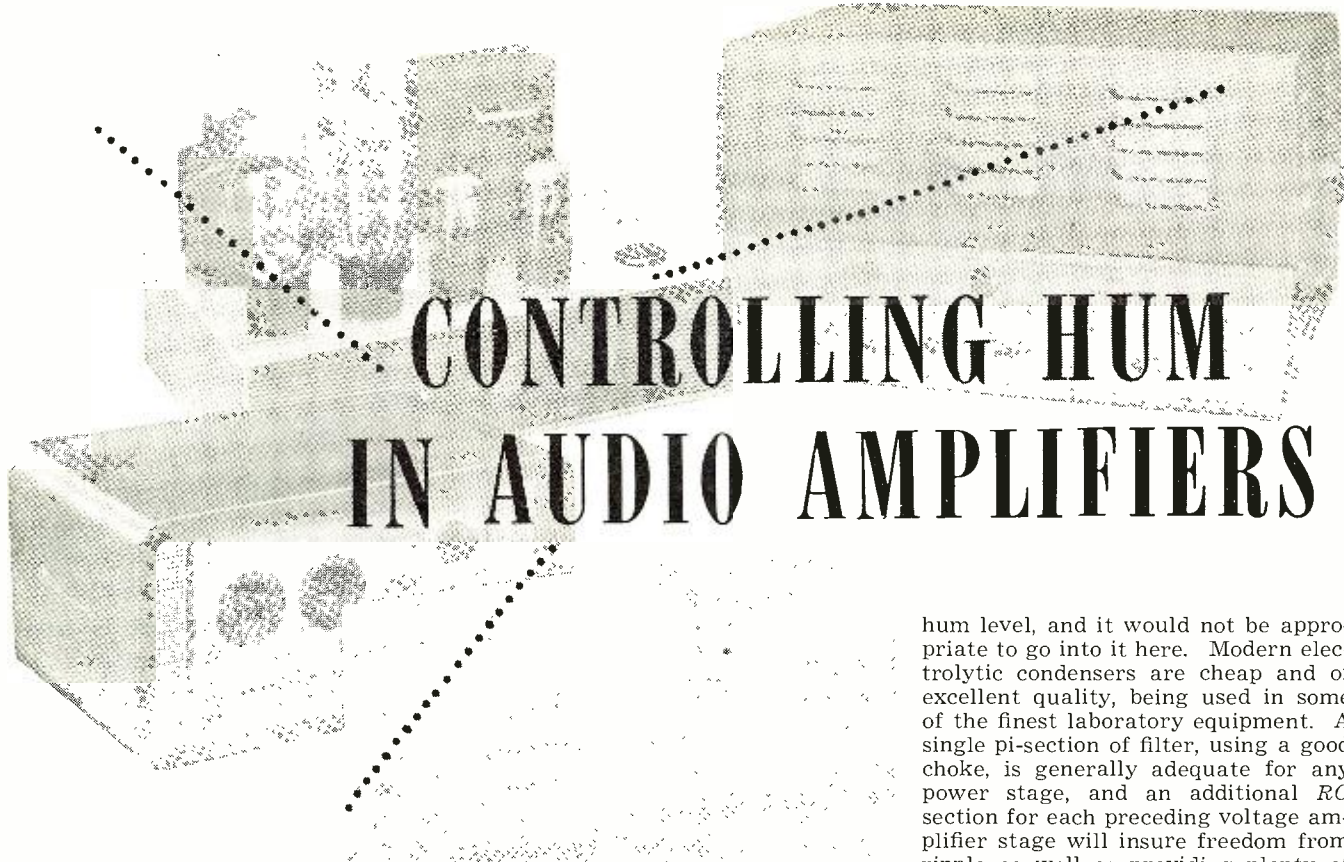

CONTROLLING HUM IN AUDIO AMPLIFIERS

By
LAWRENCE FLEMING

How to recognize characteristic types of hum and simple methods for attenuating this interference.

THE reduction of hum is a problem that sooner or later confronts every designer or builder of a.c. powered audio equipment. When there is plenty of room on the chassis and the input signal level is fairly high, say 1 volt, the job may amount to no more than relocating a grid lead or remembering to ground the heater supply. High-gain equipment however, working from a microphone or other low-level input, can present some tricky problems.

The purpose of this article is to describe the different ways in which hum can enter audio systems, to give some guide to the recognition of characteristic types of hum from different sources, and to cover practical methods of getting rid of the stuff. Shielding, chassis layout, planning of ground leads, choice of tubes, and filtering all enter into the problem. No instruments are needed to do a good job, although an oscilloscope is very helpful and a high-sensitivity a.c. vacuum tube voltmeter quite useful.

High-fidelity reproduction of sound demands a much lower relative hum level than does ordinary radio quality. In a good audio system the hum (as well as other noise) should be 50 or 60

db. below average listening level. Out of a 5-inch speaker a 30 db. ratio is tolerable. Public address amplifiers are often rated in hum level below full output. In a high-quality home installation this type of rating is misleading, because a good 20-watt amplifier in a living room is usually operated at 1 or 2 watts output, while the p.a. system is run closer to full blast.

The low signal levels available from tape playback heads and variable-reluctance phonograph pickups, together with the bass equalization required, aggravate the situation. Two other factors tend to alleviate it somewhat; the comparatively small dynamic range of records and tape—30 to 50 db., and the low impedance of such pickups at 60 cycles. With these new low-level input sources in wide use, however, good quality reproduction requires more careful attention to the reduction of hum than ever before.

Plate supply ripple due to insufficient filtering is always a pure 120-cycle note, and can be readily located by clipping extra condensers across the "B" supply. The actual design of power supply filters is a process of calculating the minimum size of chokes and condensers to insure a certain

hum level, and it would not be appropriate to go into it here. Modern electrolytic condensers are cheap and of excellent quality, being used in some of the finest laboratory equipment. A single pi-section of filter, using a good choke, is generally adequate for any power stage, and an additional RC section for each preceding voltage amplifier stage will insure freedom from ripple as well as providing plenty of decoupling. There should be some series impedance in the positive side of the filter system, not all in the negative side, to get rid of ripple coupled through the power transformer capacitance. It is important to remember that filtering action is better for a given section, the lower the d.c. current drain, so that an RC filter section supplying only a milliampere or two to a resistance-coupled stage will give you much more filtering for your money than a similar section feeding a stage that draws a lot of current.

Many excellent commercial amplifiers use no filter chokes at all, and many fewer sections than suggested above. One can usually get satisfactory results with this type of design, but the proper procedure is to start out with plenty of filter, and then start cutting down and rearranging.

Push-pull stages require less filtering and decoupling than single-ended stages. Power pentodes are more tolerant of plate (not screen) supply ripple than are triodes, because of their high plate resistance, *i.e.*, a volt of ripple produces less plate current swing. Negative feedback over the output stage will attenuate hum originating in that stage, but will not reduce hum originating at the input end of the feedback loop.

Plate Impedance Effect

The ripple voltage actually appearing at the plate of a tube is less than that at the "B + " terminal by the ratio: $R_p / (R_i + R_p)$ where R_i is the plate load resistance, and R_p the plate resistance of the tube. In Fig. 1, if the tube is a 6J5 operating with a

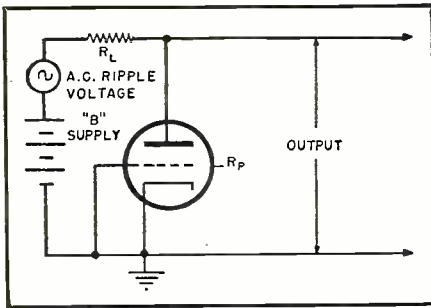

Fig. 1. Voltage divider effect attenuating plate supply ripple. The tube output is less than the "B" supply ripple by approximately the ratio of plate load resistance to plate impedance of the tube.

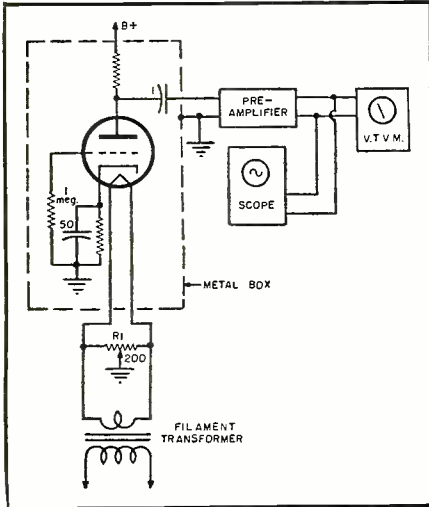

Fig. 2. Setup for measuring tube hum.

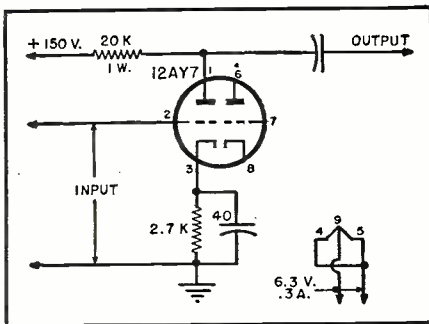
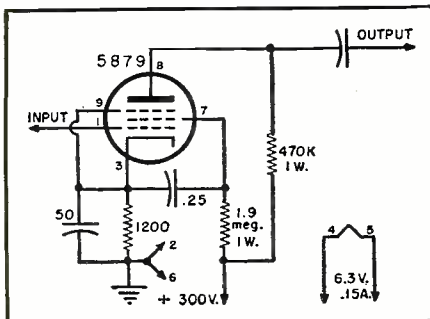

Fig. 3. Manufacturer's recommended circuit for 12AY7 as a low-level amplifier. Only one of the triode sections is shown.



Fig. 4. Recommended circuit for new RCA 5879 as a low-level audio amplifier. Pins 2 and 6 should be grounded. Gain is 150.



100,000 ohm load R_L and a plate impedance R_p of 10,000 ohms, only $\frac{1}{11}$ of the "B" supply ripple will appear at the plate. An attenuation of at most 2 or 3 to one can be obtained with high- μ triodes, and practically none with pentodes.

Grounding and Balancing

In wide-range, low-level equipment with a.c. heater supply to the input stage it is advisable to use a hum-balancing potentiometer of 200 ohms or so across the heater supply, with the arm grounded. This adjustment will usually reduce the hum level of the input stage 10 db. over the level obtained when using a fixed center-tap. The total reduction over an arrangement with one side of the 6.3-volt supply grounded is from 20 to 30 db. The optimum adjustment varies slightly from tube to tube, and is less critical the lower the impedance in the grid circuit.

Everyone knows that heater supplies should be tied to ground or to a point having some definite d.c. potential (and bypassed to ground with 0.1 μ fd. or so) but the reason why may not be obvious. A floating heater supply winding assumes a high a.c. potential, which it obtains through its capacitance to the high-voltage winding of the power transformer. Through capacitance and leakage from heater to grid, and other paths, this high a.c. potential couples large hum voltages into the signal circuits. It can even break down the heater-cathode insulation inside tubes.

When one side of the heater supply is grounded, the a.c. potential available for such stray coupling into the signal circuits is only 6 volts instead of perhaps 300.

When the center-tap is grounded, two a.c. potentials of 3 volts each are on hand, to couple hum into the grid circuit, but are 180 degrees out of phase. Their effects approximately cancel. If the stray impedances from each side of the heater to the grid are exactly equal, an exact center-tap will neutralize the hum. Since they are not exactly the same an adjustment is necessary.

Choice of Tubes

Table 1 lists tubes recommended by the manufacturers for low hum, noise, and microphonic applications. Table 2 gives hum data on some standard receiving types as measured by the author.

For commercial service it is better to use one of the special types listed in Table 1, since the hum characteristics of ordinary types often depend on variables that are not controlled in production, and the special types are better and more consistent microphonically. Type 1620 was omitted from Table 1 because it is seldom seen nowadays. It is a selected 6J7.

Nevertheless, a selected 6AU6, with a hum balance adjustment, can be so quiet that nothing but thermal noise can be seen on an oscilloscope, i.e., an equivalent hum input at the grid of

less than 10 microvolts, when using a 1 megohm grid resistor.

The data in Table 2 is based on measurements made on four tubes of at least two different makes of each type. The test circuit is shown in Fig. 2. Plate resistors were 470,000 ohms for pentode types and 100,000 ohms for triodes. Cathode and screen resistors follow tube manual recommendations. The 6AU6 was best, the 12AT7 next, and a close third was type 6J7, the old standby of the broadcast industry for preamplifier service. 6C4's were spotty and generally poor. All these types require selection for good results. One-half to a third of a random collection of tubes might turn out good. The 6J7 may have the edge on microphonics; some 6AU6's are loose inside and noisy, but a good one is excellent. 12AT7's showed more variation than 6AU6's. The latter, incidentally, with screen and suppressor tied to the plate makes a good triode with a μ of 40.

Investigation of larger samples of these and other modern miniature types should be very fruitful, and it is hoped that someone with the time and facilities will undertake it.

Figs. 3 and 4 show typical circuits recommended by the manufacturers for the 12AY7 and the 5879. An exception is that screen and cathode bypasses are shown larger for the 5879 than the data sheet recommends, because it is felt that cutting down the bass response is not the best way to reduce hum.

Fig. 5 shows a complete low-level input stage using a 6AU6, on which was measured a hum output equivalent to less than 10 microvolts at the grid. The "B" supply was a conventional transformer and rectifier system with one pi-section of filter, but the only current drain was that of the stage shown.

Inside Tubes

Several things inside a tube contribute to a.c. ripple in its output. Consideration of these factors leads naturally to circuit planning for hum reduction, too; and these will be taken up presently. The first source of hum in the tube is leakage current between the heater and the cathode. This current is said to be around 0.04 microampere for voltage amplifier types and 1 microampere for power tubes. No definite data is available, but this leakage current probably increases greatly over these values as the tube ages. It is known to increase with heater voltage. Low-level audio stages should never have over 6.3 volts applied to the heater, and preferably about 5.8 volts. In the circuit of Fig. 5, increasing the supply from 5.8 volts to 6.6 volts doubled the hum output.

The effect of this leakage current is eliminated by keeping the d.c. potential low between heater and cathode (not over 10 or 20 volts) and by using a cathode bypass capacitance of not less than 40 μ fd.

Electrolytic condensers are perfect-

ly quiet. Grid bias cells however are apt to be noisy at millivolt levels.

It is very difficult to get the hum low in a cathode follower.

Heater-Grid Leakage

Resistive leakage from heater to grid can be troublesome. If, for example there is 10,000 megohms of unbalanced leakage from a 6 volt source to the grid, and the input circuit impedance is 1 megohm, 0.6 millivolt of 60 cycle a.c. will appear at the grid. Leakage of this magnitude is not unusual across black phenolic tube bases and sockets, not to mention cotton insulation on pushback wire. With single-ended tubes, mica-filled or ceramic sockets are advisable.

Heater-Grid Capacitance

The capacitance between the heater leads and the grid is an important hum characteristic of a tube type. The low-noise types in Table 1 have internal shielding between the grid and heater. 1 $\mu\text{fd.}$ of stray unbalanced capacitance here will introduce 2 millivolts of hum into a 1 megohm grid circuit. The situation is saved in practice by hum balancing and by the fact that the actual capacitance inside miniature tubes is less than 1 $\mu\text{fd.}$, and that the impedance presented to the grid circuit by phonograph pickups, tape heads, and microphones is a good deal less than a megohm, provided, that is, that the layout minimizes the stray capacitance which unavoidably remains.

Capacitive Hum Balancing

A fine adjustment on heater supply center-tapping can be obtained by trimming the capacitances between either side of the heater and the grid, as well as by using a potentiometer. Adequate trimming can usually be effected by lead dress alone. Bring an inch or less of heater lead close to the grid lead, using an insulating rod for a tool. One side of the a.c. supply will increase the hum level, the other side will reduce it. Observation of the tube output on an oscilloscope or meter is rather necessary during this operation.

Wiring Techniques

Most of the considerations outlined above as relating to hum in tubes apply as well to the wiring that goes to the tubes. Capacitance from any a.c. wiring to a low-level signal circuit introduces a 60 cycle voltage therein in direct proportion to the a.c. voltage present, the stray capacitance, and the impedance of the affected circuit. In Fig. 6A, suppose we have a grid circuit with a resistance R of 1 megohm, having its high side coupled to a source of a.c. E_H through a stray capacitance C_H . If the hum voltage E_H is 1 volt, there will appear at the grid $1/2300$ of a volt, or about half a millivolt, since the reactance of 1 $\mu\text{fd.}$ at 60 cycles is about 2300 megohms. This is only 26 db. below 10 millivolts. If C_H should be coupled to a 300-volt

TYPE	HEATER	DESCRIPTION
12AY7	6.3/12.6 v.; .3/.15 amp.	Double triode, noval miniature, $\mu = 35$
5879 (RCA)	6.3 v.; .15 amp.	Voltage amplifier pentode, noval miniature
347A (Western Electric)	6.3 v.; .6 amp.	Triode, glass octal with top cap, $\mu = 16$

Table 1. Tubes recommended for low-hum, low-microphonic applications.

power transformer lead, the grid circuit would receive 300/2300 volt, or 0.15 volt—an intolerable level. 1 $\mu\text{fd.}$ is about what you get between two pieces of pushback wire an inch long twisted loosely together.

Fig. 6B illustrates the same situation when the signal source C is capacitive, as crystal microphones and pickups. The stray "hum" capacitance and the signal source act simply as a capacitive voltage divider. If C is 2000 $\mu\text{fd.}$ and E_H 1 volt, the a.c. voltage at the grid will be $1/2000$ volt.

All this does not mean that one should shield the daylights out of all low-level wiring, and locate input stages a yard away from everything else. Rather, it is necessary to be aware of the magnitudes of these effects, and to recognize a defective wiring layout. Lavish use of tinned copper braid is rarely necessary. It is really needed only to salvage a poorly-planned chassis layout, or in unusually compact assemblies, or when gain and tone controls are grouped together at some point removed from the associated circuits. The capacitance between two wires can be very close to zero if (1) they are a couple of inches apart, (2) they are kept close to the chassis, not up in the air; and (3) advantage is taken of natural cover to help in shielding, i.e., bypass condensers, d.c. wiring, and other "cold" components.

Twisting of heater leads, incidentally, is not too necessary if they are close together and grid leads are kept away. With top-cap tubes it is well to use braid on the grid lead and to put a "hat" shield over the grid cap.

Magnetization of Tubes

Glass tubes of a given type show more individual variation in hum level

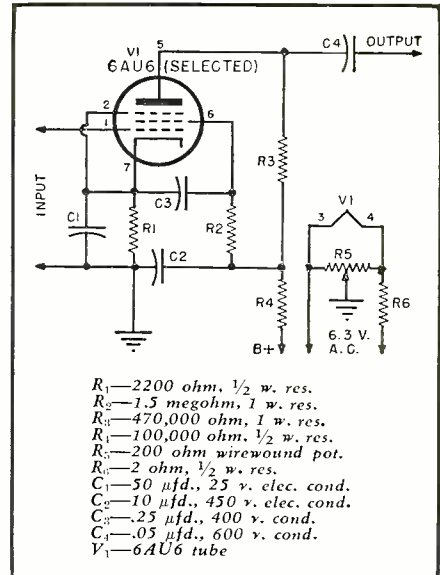

Fig. 5. Low-noise preamp using 6AU6.

- R_1 —2200 ohm, 1/2 w. res.
- R_2 —1.5 megohm, 1 w. res.
- R_3 —470,000 ohm, 1 w. res.
- R_4 —100,000 ohm, 1/2 w. res.
- R_5 —200 ohm wirewound pot.
- R_6 —2 ohm, 1/2 w. res.
- C_1 —50 $\mu\text{fd.}$, 25 v. elec. cond.
- C_2 —10 $\mu\text{fd.}$, 450 v. elec. cond.
- C_3 —25 $\mu\text{fd.}$, 400 v. cond.
- C_4 —.05 $\mu\text{fd.}$, 600 v. cond.
- V_1 —6AU6 tube

TYPE (Referred to Grid)	HUM LEVEL	REMARKS
6AU6	5-10 $\mu\text{v.}$	Fairly uniform
12AT7	10-30 $\mu\text{v.}$	Not very uniform, some tubes noisy and microphonic
6J7	30-50 $\mu\text{v.}$	Fairly uniform and quiet
6C4	10-100 $\mu\text{v.}$	Wide variation, some tubes very noisy

Table 2. The measured attainable hum levels of standard receiving tubes.

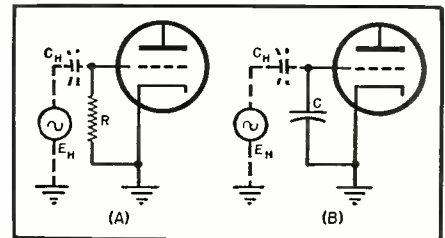

Fig. 6. (A) Capacitive hum pickup. (B) Capacitive hum pickup in crystal microphone or in phonograph input circuits.

than metal tubes. The British journal *Wireless World* has reported the discovery that this phenomenon is associated with permanent magnetization of the tube elements, which seems to increase the hum level in a way not

Table 3. Some of the most common sources of hum and a listing of possible remedies.

SOURCE	REMEDY
1. "B" supply ripple	Filtering; use larger screen bypass in pentodes; use high load resistance with triodes.
2. Capacitive pickup from a.c. wiring to tube grids	Separation of leads; shielding; use potentiometer for grounding center of heater supply.
3. Heater-grid leakage	Mica-filled or ceramic sockets; keep wiring separated.
4. Heater-cathode leakage	Use cathode bypass of at least 40 $\mu\text{fd.}$ Try positive d.c. bias of about 5 v. on heater supply.
5. Magnetic a.c. modulation of tube plate current	Locate input tube 6" or more from power transformer and phono motor. Use iron shield on glass tubes.
6. Chassis gradients	Ground grid return and cathode return to same point.
7. Gradients along cable shields	Ground mike or phono pickup shield at one point only; use separate lead to interconnect chassis; keep both leads close together.
8. Ground loops	Keep grid and return leads close together and away from power transformer. Interconnect ground tie points through only one path. Do not duplicate separate chassis grounds with wire interconnections.

yet understood. The remedy is demagnetization with a gradually-removed 60 cycle field, the same as jewelers do with watches. The winding of an old power transformer, removed from the core, can be used for a demagnetizing coil. Connect the secondary across the 115 volt line (using series resistance if necessary, to keep it from getting too hot), insert the tube, then slowly withdraw it.

Chassis Currents

Gradients of the order of half a millivolt per foot often exist across a chassis on which a power transformer is mounted. The transformer winding induces a 60 cycle voltage, causing a circulating current in the chassis. Hence it is not good to include a hunk of chassis in series with a low-level input circuit. Fig. 7C illustrates what happens when the cathode and grid of a tube are returned to different points. E_H denotes a hum voltage distributed along the chassis. This voltage is included right in with the signal. The remedy is to return grid and cathode to the same point, as in Fig. 7F.

Ground Loops

When one starts wiring from a diagram without thinking too much about the purpose of each lead, the situation indicated in Fig. 7B may develop. Here, too many ground leads have been used, forming a shorted turn or ground loop. Stray magnetic fields eagerly induce a.c. voltage in such a loop, and the voltage across a portion of the loop is included in the grid circuit. The effect is usually very small, but an aggravated case can cause trouble.

If the grid lead and grid return be too widely separated, as indicated in Fig. 7E, another one-turn coil is created, ripe for the induction of 60 cycle voltage. Since the voltage induced in a loop is proportional to its area, the remedy is to keep the grid

lead and return lead close together.

These magnetic effects are aggravated when they are on the low-impedance side of an input transformer. Phonograph motors have magnetic fields just like power transformers.

Magnetic Pickups

Fig. 7A shows a situation often encountered when using pickups of low output level, such as the *GE* and *Pickering*. Here the shielded pickup cable is grounded to the motor frame at one end, and to the amplifier chassis at the other. The motor frame has a fair-sized capacitance to the 110 volt line, as does the amplifier chassis. These capacitances are indicated as C_1 and C_2 in the diagram, with the line voltage in between. C_1 and C_2 can be as large as 0.1 μ fd. if line isolating condensers are used. A hum voltage is thus applied across the ends of the cable shield, and the resulting voltage drop can be as much as 50 microvolts, included directly in the grid circuit. The remedy is to use the shield only for the signal voltage, and to employ a separate wire to connect the two chassis, as shown in Fig. 7D. This wire should be close to the cable to avoid loop pickup effects which can be just as bad. Two-conductor shield cable can be used, too.

Tape Recorders

Tape playback is the most critical problem of all, because of the very low output level of tape heads—1 millivolt or so—and the heavy bass equalization required. All the precautions must be observed. An important residual hum source is a.c. magnetic induction in the playback head itself. *Audio Engineering* has reported a simple method of neutralizing the residual induced hum. Attach a small piece of sheet iron, $\frac{1}{2}$ inch square or so, to a stick, and try holding it in various positions near the playback head until a location is found that dips

the hum level to a minimum. Then permanently fix the iron piece in place. *Permalloy* is better.

The iron acts as a distorter of the field, and, in the right position equalizes the effective fields applied to the two sections of the hum-bucking winding used in the head.

Audio Transformers

Unshielded low-level input transformers pick up hum from power transformer and motor fields, typically on the order of a few millivolts across the high winding. At microphone levels, an ordinary strap-mounted or similar input transformer simply cannot be used on the same chassis with a power transformer. This is why intercom sets always use an a.c.-d.c. type circuit.

Transformers of the two-coil "hum-bucking" construction are somewhat better. If adjustably mounted at least a foot from the power transformer, such a unit can be oriented to be quiet enough for p.a. purposes, but not for broadcast quality. The small "ouncer" size is about as good, since hum pickup decreases with size.

By far the best construction is that with multiple telescopic *Permalloy* shields. A cast iron case alone does little good. Multiple alloy shielded units are at least 30 db. better than any other construction. The writer disassembled a transformer of this type once and found that each shield can reduce the induced hum 20 db., a total of 60 db. for the three cans.

Hum Characteristics

Fig. 8 shows tracings taken from an oscilloscope screen, with typical waveforms of a.c. pickup from various sources. They have certain distinctive qualities. Straight capacitive pickup is a slightly rough 60-cycle wave. Plate supply ripple due to insufficient filtering is a very smooth
(Continued on page 180)

Fig. 7. (A) Hum induction by using cable shield to interconnect phonograph turntable and amplifier chassis. (B) A ground loop. One of the three ground leads should be opened. (C) Hum injected into input circuit from a.c. voltage gradient along chassis. (D) Correct method of connecting low-level phonograph pickup to amplifier. (E) An input wiring loop. This can give trouble in tape playback input circuits if loop is close to motor or power transformer. Shielding grid lead alone will not help. Loop must be closed up by making shield the only path between low side of signal source and cathode return of first tube. (F) Grounding grid return and cathode to same point to avoid hum from chassis gradients.

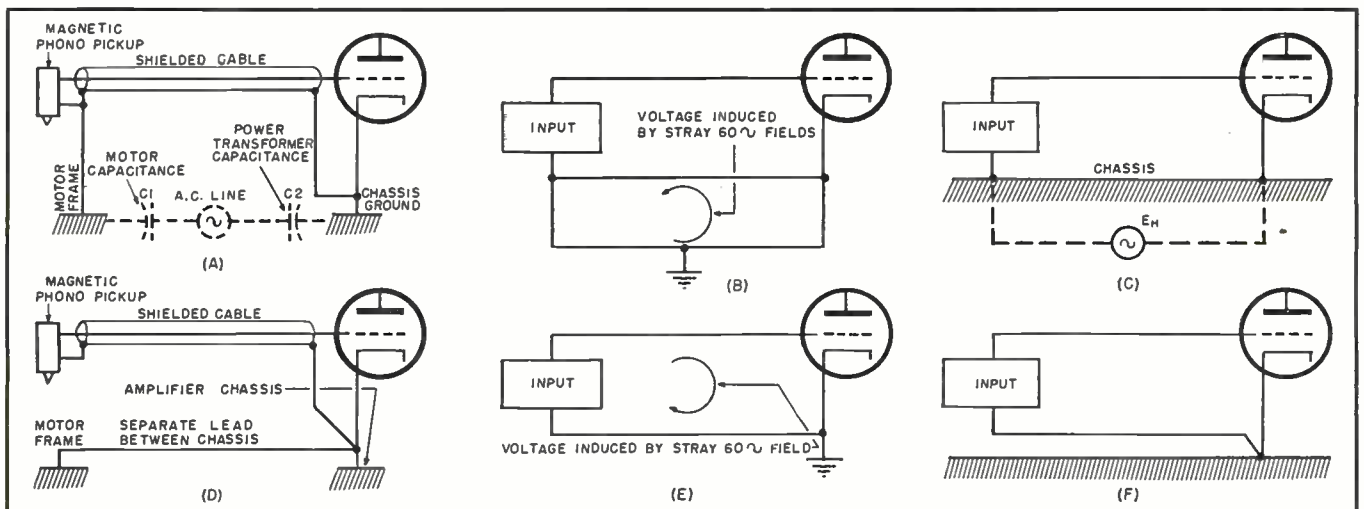

A High-Quality SOUND SYSTEM for the Home

By
H. F. OLSON
&
A. R. MORGAN
RCA Laboratories

THE main objective of this article is a rationalization of the problems confronting the enthusiast for good sound reproduction.

The statement, "high quality sound reproduction," implies a desire for realism or naturalness in the reproduced sound. The ideal in sound reproduction would result from subjecting each of the listener's ears to the exact sound that would be received by attending the original source. To achieve this ideal, resort must be made to such complications as Binaural¹ or Auditory Perspective^{2,3,4} Reproducing Systems. These systems are not within the province of practicality and need be discussed no further.

Practical considerations dictate the use of monaural or single channel reproducing systems. The ideal of this system would be an exact reproduction, from the loudspeaker, of the sound impressed on the microphone of the system. To the enthusiast, then, the basic problem involves the cost of a satisfactory approach to this ideal. He finds that he must weigh such factors as response, distortion, and power output against cost.

A reasonable solution for the problem will result from limiting the demands on the system to those which are truly needed for satisfactory high-quality sound reproduction in the home. If this approach is used, it is possible to develop a wide range, low distortion sound reproducing system in which the cost is comparable to the cost of mass produced systems.

It is a further objective of this ar-

¹Olson and Massa; "J. Soc. Mot. Pic. Eng.," Vol. 23, No. 2, p. 63, 1934.

²Fletcher, H.; "J. Soc. Mot. Pic. Eng.," Vol. 22, No. 5, p. 314, 1934.

³Maxfield, Colledge, Friebus; "J. Mot. Pic. Eng.," Vol. 30, No. 6, p. 666, 1938.

⁴Fletcher, H.; "J. Acous. Soc. Amer.," Vol. 13, No. 2, p. 89, 1941.

⁵"Bell Laboratories Record," Vol. 12, No. 10, p. 314, 1934.

⁶Snow, W. B.; "J. Acous. Soc. Amer.," Vol. 3, No. 1, Part 1, p. 155, 1931.

⁷See "Tanglewood Demonstrations," later in this article.

Fig. 1. Complete sound system including a 91Y record changer, amplifier, and the RCA type LC1A loudspeaker and cabinet assembly.



Analysis of the problems encountered by the audio enthusiast in designing and building his own relatively low-cost, high-quality audio system.

title to describe in detail the elements and performance characteristics of a practical high-quality sound reproducing system consisting of a record player, amplifier, loudspeaker unit, and cabinet. This description will enable the enthusiast to assemble a high-quality sound reproducing system at a moderate cost.

Frequency Response

To determine the frequency response needed for an ideal sound reproducing system, it is necessary to consider, in combination, the response of the human ear and the frequency ranges encountered in speech and music. The frequency range of the average normal ear⁵ is from 20 to 20,000 cycles. It is likely that frequencies higher and lower than the limits of the ear will, at times, be encountered in music or in certain noises. It has been shown^{6,7} however, that the frequency range required for no appreciable loss in quality of reproduction is from 40 to 15,000 cycles. This range, therefore, might well be treated as an ideal.

Any attempt to evaluate the effect of restricting the frequency range of reproduction involves a personal judgment of quality and for all but minor range restrictions can be very confusing. Since the purpose of this discussion is to establish a criterion for high-

quality reproduction, the drastic frequency range restrictions are, fortunately, not important. If terms such as: "Almost as satisfactory," or "Slight effect upon tone quality," be taken as a criterion, it can be shown⁶ that a frequency range from 60 to 10,000 cycles would be indicated.

The choice between ideal and restricted frequency ranges reduces to a balance between cost and performance. It appears, therefore, that the enthusiast must make his own decision as to the desirability of using less than ideal response.

Distortion

The allowable amount of distortion in a high-quality sound system is rather difficult to specify. The difficulty lies in the lack of any but general correlation between subjective and objective tests on distortions in sound reproducing systems.

Some idea of the subjective effects of distortion can be obtained from a study of the masking curves of the human ear. It will be seen, for instance: that the higher order harmonics are more easily discerned than the lower order harmonics; that the masking of harmonics increases as the signal level increases; that difference tones may be of more importance than the harmonics. With the complex

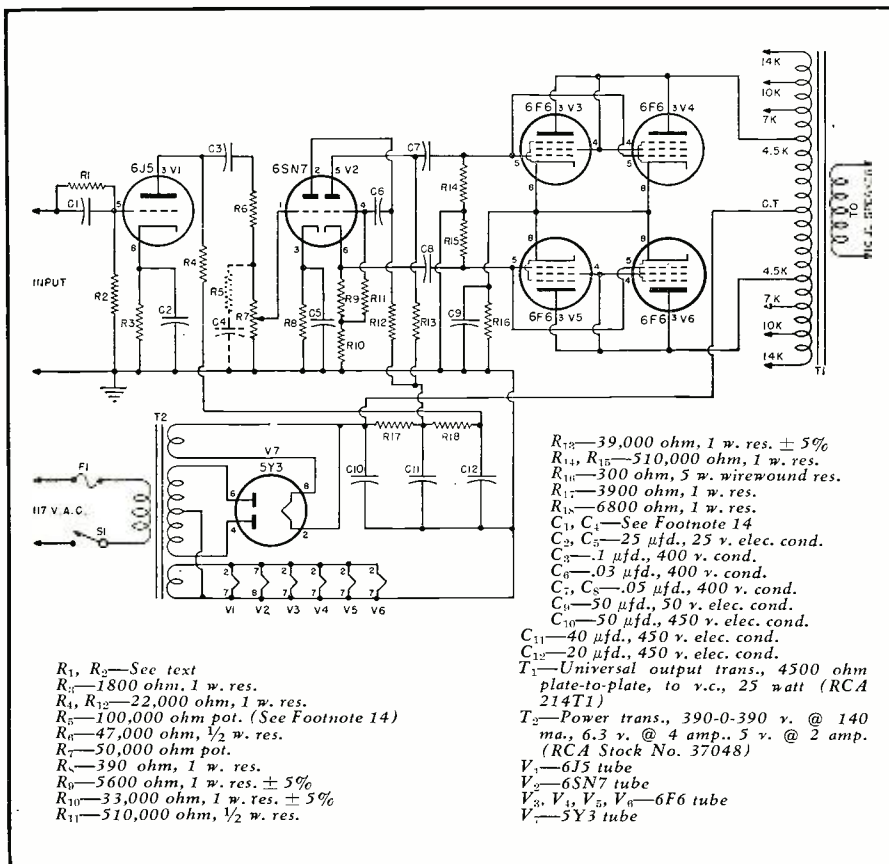

Fig. 2. Diagram of triode amplifier. It is straightforward and easy to duplicate.

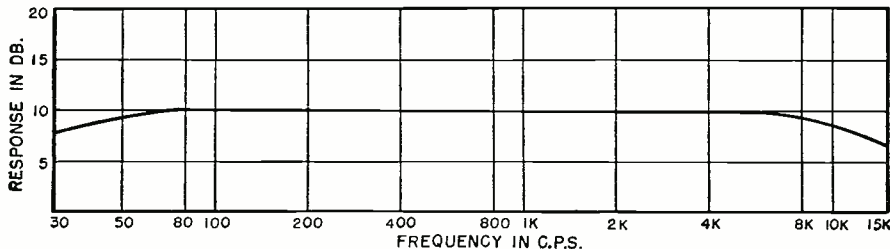

Fig. 3. Output response of amplifier for constant voltage at grid of the input tube.

waves of speech and music it becomes more difficult to speak, even in generalities. The amount of masking depends on the spectral distribution of the sound. A general idea can be obtained from a consideration of the masking effects of wide-band thermal noise. It is seen that at higher levels it becomes increasingly difficult to detect harmonics. The authors and their associates have reached a similar conclusion regarding the masking of distortion by higher level speech and music. Furthermore, it has been observed that the sensitivity of the ear to distortion in music appears to be a

maximum for sound levels in the vicinity of 70 to 80 db.

If an attempt is made to evaluate the subjective effects of distortion, it immediately becomes evident that a continuous scale of values is impossible. Resort must be made to grouped gradations, such as; perceptible, tolerable, or objectionable. A perceptible level of distortion is dependent on experience and is, therefore, a fairly definite quantity. Tolerable and objectionable levels of distortion are dependent on personal opinion and are, therefore, very indefinite.

Obviously, the perceptible level of

Fig. 4. (A) Total harmonic distortion of the RCA 515S1 and (B) the RCA LC1A speakers.

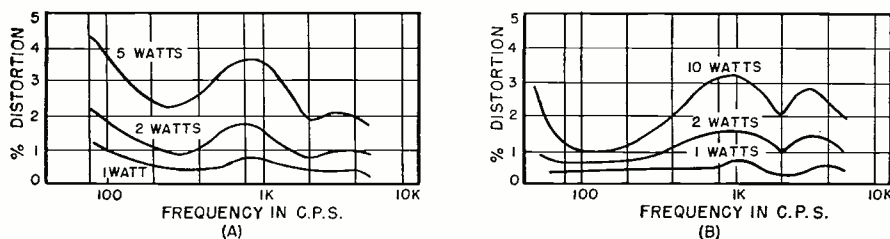

distortion can be used as an ideal—one can hardly ask for more than being unable to hear the distortion. For the type of distortion contemplated, for the frequency response contemplated, and for a sound level of 75 db, it has been shown⁸ that a total r.m.s. distortion of approximately 0.75% is perceptible to critical listeners. This figure, therefore, is selected as the ideal for distortion performance. As pointed out before, the ear is not as critical at higher sound levels. It is probable, therefore, that this ideal figure can be relaxed for higher sound levels.

Any compromise with the ideal of distortion performance becomes so involved, with the items mentioned previously, that a single answer as to what constitutes tolerable distortion is unavailable. Distortions greater than ideal are most likely to occur at the higher power or sound levels. If it is assumed, for the moment, that ideal distortion performance can be achieved at intermediate (and lower) levels, then the concern is reduced to consideration of tolerable distortion at higher levels. It is the opinion of the authors that, for the type of reproduction contemplated in this article and for sound levels of 90 db., total r.m.s. distortions of 2 to 3% are tolerable.

Power Output

The electrical power input and sound power output of a loudspeaker are related by the efficiency of the loudspeaker. The electrical power requirements are, therefore, directly dependent on the sound level requirements.

Sound level requirements will vary, depending on individual tastes. It appears that, in the home, a habit pattern has developed from radio listening. It would seem that the radio volume control is adjusted so that speech is reproduced at ordinary conversational level and then no change is made as the program changes to music or whatever. Ordinary conversation has an average sound level of approximately 70 db. Opinion and scattered tests of sound levels found in home reproduction offer a figure ranging from 65 to 75 db.

Numerous demonstrations of high fidelity sound reproduction have been made to visitors to the RCA Laboratories. The demonstrations were made in the Living Room Laboratory which is representative⁹ of a typical living room in a house or apartment. The average power input to the loudspeaker for these demonstrations was approximately 0.050 watt and resulted in an average sound level of approximately 80 db. This sound level has been objected to by some as being too loud, but never as being too low.

From the above, it would seem that an average sound level of approximately 75 db. would be adequate for most home reproduction. The power corresponding to this sound level would be approximately 0.016 watt.

⁸Olson, H. F.: "Elements of Acoustical Engineering," 2nd Edition, pages 488-491.

⁹H. F. Olson: "J. Acous. Soc. Amer.," Vol. 15, No. 2, 96-102, Oct. 1943.

For satisfactory performance, a sound reproducing system must be able to handle the power peaks encountered in speech and music. It has been established,^{10,11} that the ratio between r.m.s. peak power and r.m.s. average power in speech and music is approximately 10 db. For an average power level of 0.016 watt the peak power would, therefore, be approximately 0.160 watt. Using round numbers and a moderate safety factor we have the surprising result that a ¼ to ½ watt amplifier would give satisfactory performance in many home installations.

There are, of course, many persons who desire the illusion of placing a large orchestra in their living rooms. Let us assume that the sound levels experienced in a concert hall for "full orchestra" from a large symphony orchestra will be adequate. It can be shown¹² that the peak sound level at a desirable seat in such a concert hall is not likely to exceed a value of 100 db. Extrapolating from the above figure of 0.050 watt corresponding to a sound level of 80 db. in an average living room, we deduce that peak sound levels of 100 db. would correspond to peak powers of 5.0 watts. It appears, therefore, that we are justified in limiting the power requirements of the amplifier and loudspeaker to approximately 5.0 watts.

Amplifier

The choice of an amplifier for a high fidelity sound reproducing system has become one of the most discussed problems in the audio field. A discussion of the problem immediately becomes involved with arguments, pro and con, concerning triodes, pentodes, feedback, power output, distortions, etc. To the innocent bystander, the consensus of these discussions, is an amplifier having, the more power the better, the lowest possible distortion at maximum power and, as a result, a disappointingly high cost.

The price of an amplifier depends on the performance required from the amplifier. Again, it seems proper, therefore, to insist only on that performance which is truly necessary. The necessary requirements for the amplifier are essentially the same as the system requirements set down before. It is very important to consider the distortion generated by the amplifier for the power level at which it will be most used. That power level would probably be of the order of ¼ watt and the distortion would be all the more important because of the increased acuity of the ear at the corresponding loudness level.

The selection of the amplifier configuration to meet the desired performance brings up the argument concerning triodes, pentodes, feedback,

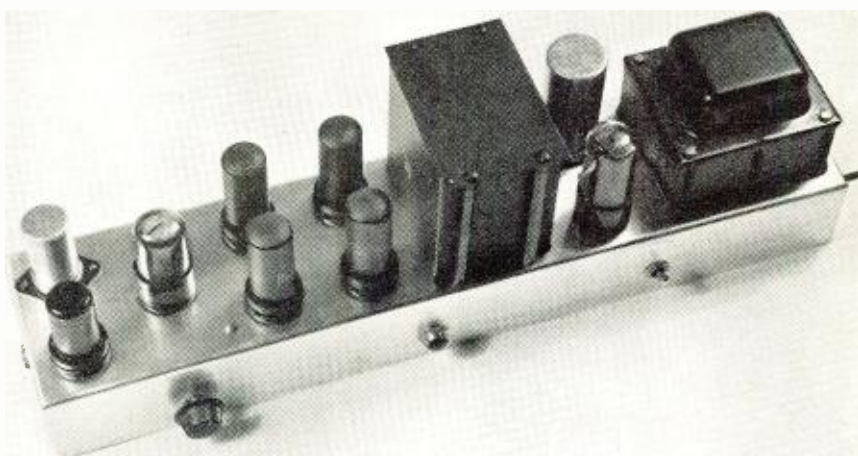

Fig. 5. Over-all top chassis view of the triode amplifier described in the text.

etc. It is generally conceded that the triode is superior to the pentode on a distortion basis. Consequently, the choice lies between the triode and the pentode with feedback. Triode amplifiers have been in commercial use for many years and, it would appear, have almost become a standard for comparison. It is claimed by many that pentode amplifiers with feedback can be made as good as or better than triode amplifiers. There is no reason to doubt this claim; however, it should be pointed out¹³ that the price for the improvement to be obtained by feedback is the necessity of design control over a considerable frequency range below and above the useful frequency range of the amplifier. It is tacitly assumed here that the benefits of feedback will be required over the whole of the useful frequency range. The particular reasons for wanting to use a pentode derive from the improved power sensitivity and plate efficiency of such tubes. In an over-all sense these advantages are reduced, when feedback is applied. Negative feedback always reduces the over-all gain of the amplifier, and hence the advantage of power sensitivity of the pentode is reduced. The saving in power supply cost, in a pentode-feedback amplifier would be practically used up in supplying the necessary quality of components to allow the desired amount of inverse feedback.

Summing up, it appears that from a performance standpoint there is prob-

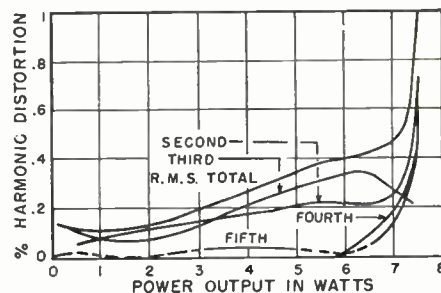

Fig. 6. The 2nd, 3rd, 4th, and 5th harmonic distortion components and total r.m.s. harmonic distortion as a function of power output measured at 400 cycles.

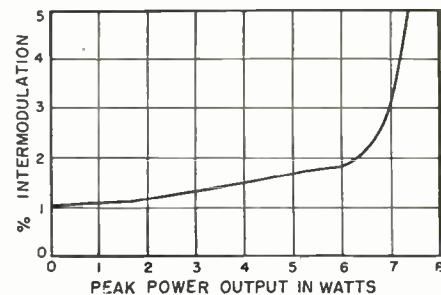
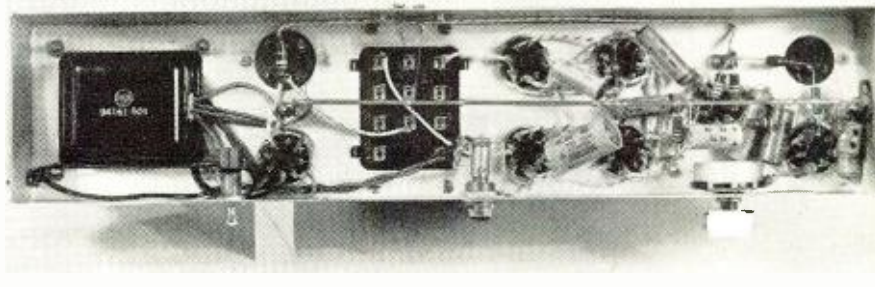

Fig. 7. Intermodulation distortion produced by combined inputs of 100 cycles and 2000 cycles. The amplitude of the higher frequency is one-fourth of the lower frequency. The curve shows total distortion, that is, the results have not been divided by 4.



Fig. 8. Under chassis view of the triode amplifier showing simplicity of wiring.



¹⁰Wolf, S. K. and Sette, W. J., "J. Acous. Soc. Amer.," Vol. 2, No. 3, p. 384, 1931.

¹¹Sivian, Dunn and White; "J. Acous. Soc. Amer.," Vol. 2, No. 3, p. 330, 1931.

¹²Bell Laboratories Record," Vol. 12, No. 10, p. 314, 1934.

¹³Bode, H. W.; "B.S.T.J.," Vol. 19, No. 3, p. 421, July 1940.

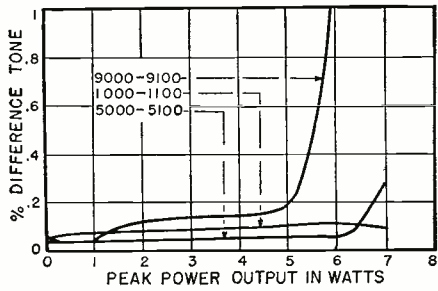

Fig. 9. Difference tone generation produced by an input of two h.f. components.

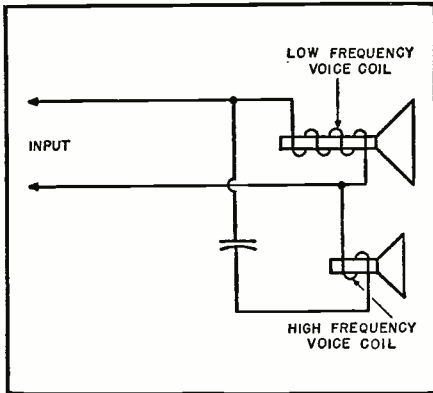

Fig. 10. Electrical crossover network of the duo-cone loudspeaker mechanism.

ably little difference between a triode amplifier and a *properly designed* pentode-feedback amplifier. From a custom design and construction standpoint the inherent simplicity of the triode amplifier is certainly to be preferred over the inherent complicacy of the pentode-feedback amplifier. There can hardly be any other conclusion than to recommend a triode amplifier for a custom type system, provided the desired performance is obtainable with the relatively few output triodes available.

A triode amplifier using readily available tubes and as simple a construction as possible has been developed. Photographs of the amplifier are shown in Figs. 5 and 8. The circuit diagram is shown in Fig. 2. The component specifications are given in the parts list.¹⁴ The simplicity of the amplifier is obvious and also leaves little to be desired.

As can be seen in the following exposition of data, the amplifier performance is well within the specifications developed above. Fig. 6 shows the harmonic distortion of the amplifier for resistive loading for 400 cycle input. The distortion is shown on an individual harmonic and on a r.m.s. total basis. To be noted is the lack of higher order harmonics. For those who may

be interested in the intermodulation distortion of the amplifier the results are shown in Fig. 7. The results of difference tone generation tests on the amplifier are shown in Fig. 9. The test consisted of introducing, to the amplifier, two equal primary voltages having a small difference in frequency. Then, the relative amplitudes of corresponding primary output voltages and the difference tone generated were determined by means of a wave analyzer. The result has been expressed as the ratio of the amplitudes of difference tone to either output voltage, in per-cent. The tests were conducted for primary voltage frequencies in the vicinity of 1000, 5000, and 10,000 cycles, and for difference frequencies ranging from 50 to 500 cycles. The power levels at which the tests were made are on the basis of the peak power obtained with the two primary voltages acting simultaneously. From a consideration of Figs. 6, 7, and 9, it

¹⁴Resistors R₁ and R₂ and C₁ are included for frequency compensation purposes and are discussed in the section on "Over-all System." If a high frequency tone control is desired, the dotted components may be added in shunt with the volume control. The 100,000 ohm tone control, R₃, should have a means for providing an open circuit at the maximum resistance end of rotation. The condenser, C₁ may have a value ranging from 1000 to 2000 micromicrofarads. The former value will provide a maximum attenuation, at 10,000 cycles, of 6 db. The latter value will provide 10 db. at the same frequency.

Fig. 11. (A—Top two rows) Directional characteristics of the RCA LC1A speaker, and (B—bottom two rows) of the RCA 515S1 speaker.

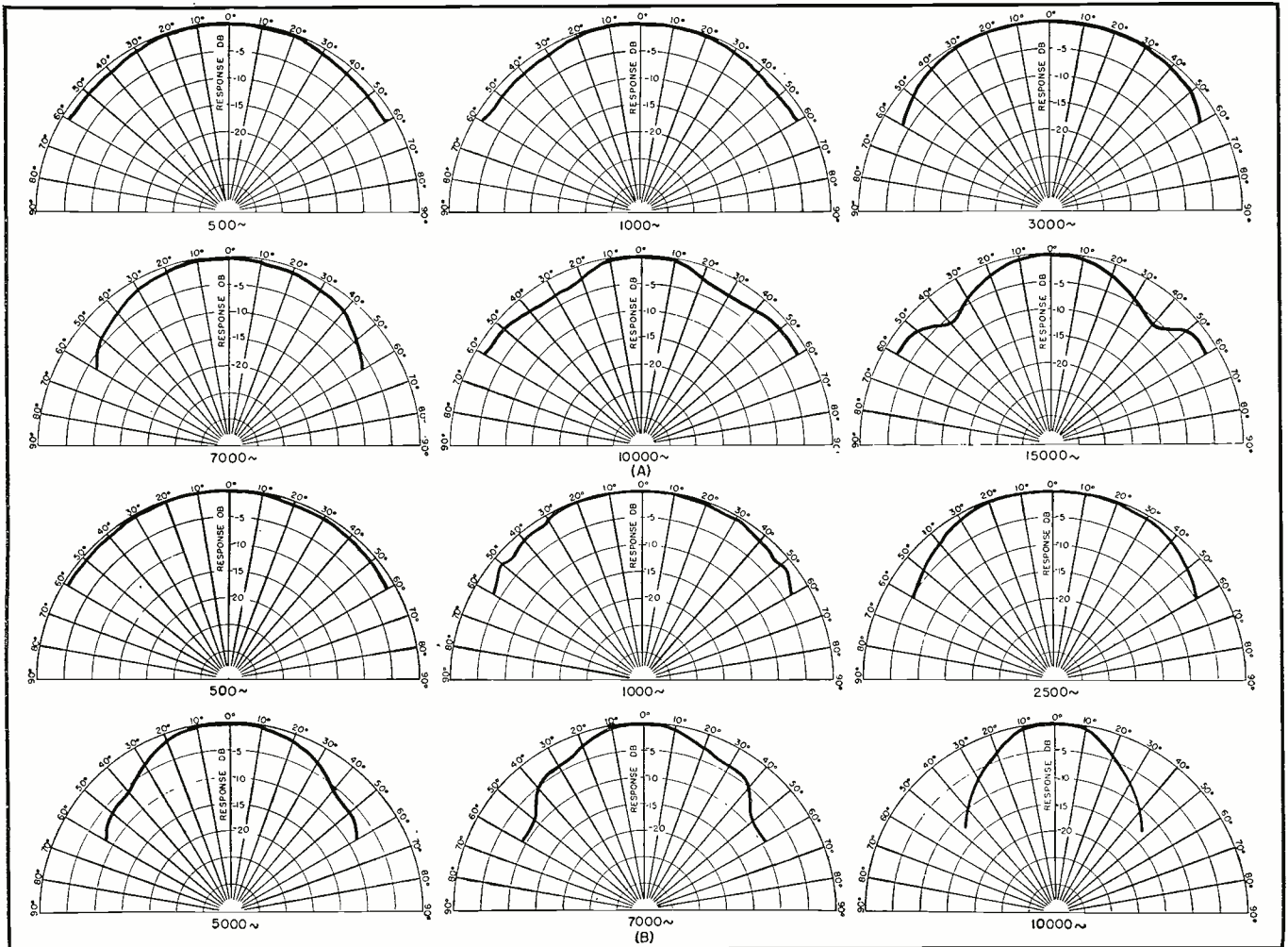

is readily seen that the amplifier leaves little to be desired for output powers up to 5 watts. The frequency response of the amplifier is shown in Fig. 3. A comparison with the loudspeaker response shown in Fig. 15 proves the amplifier response to be adequate.

Loudspeaker Mechanism

Two duo-cone loudspeaker mechanisms were used for this reproducing system, namely the RCA LC1A¹⁵ and the RCA 515S1.¹⁶ The LC1A duo-cone is the custom-built deluxe loudspeaker mechanism covering the frequency range from 40 to 15,000 cycles with a broad directivity pattern and low distortion, while the 515S1 is the mass-produced loudspeaker with somewhat restricted performance characteristics. Both of these loudspeakers, as shown in the photographs of Figs. 12 and 13, use separately driven cones, a large cone for the reproduction of the low frequency range and a small cone for the reproduction of the high frequency range. The crossover frequency between the two cones is about 2000 cycles. The large voice coil, used to drive the large cone, exhibits sufficient inductance to adequately limit the current in the large cone in the high frequency region without the use of an auxiliary inductance. A condenser in series with the high frequency coil limits the current in the small voice coil in the low frequency region. The crossover network is shown in Fig. 10. The two cones are placed congruently so that in the overlap region the diaphragms vibrate as a single unit.

In the RCA LC1A mechanism separate magnets are used to energize the two air gaps. In the RCA 515S1 mechanism a single magnet is used to energize the small and large air gaps. A magnetic bridge arrangement allocates the appropriate amount of flux to each of the air gaps. In the 515S1 mechanism the outside suspension of the small cone is fastened to the large cone. A mechanical network is used to prevent interaction between the two cones. The small cone does not vibrate at the low frequencies because the inner suspension is much stiffer than the outer suspension. In addition, the space between the cones is vented in the large cone to prevent coupling due to the compliance of this volume. In the RCA LC1A the large and small cones have independent suspensions.

There are many possible sources of distortion in a dynamic direct radiator loudspeaker. A few of the most common sources of distortion are as follows: The suspension system; small rigidity in the cone; non-homogeneity of the air gap flux; and inadequate flux density in the air gap. Every effort was made to develop a loudspeaker system in which these distortions would be as low as possible without adding unduly to the complexity of

¹⁵Olson and Preston: "RCA Review," Vol. 7, No. 2, page 155, 1946.

¹⁶Olson, Preston, Cunningham: "RCA Review," Vol. 10, No. 4, page 490, 1949.



Fig. 12. The RCA LC1A speaker mechanism.



Fig. 13. The RCA 515S1 speaker mechanism.

construction, the sensitivity, or the cost.

Cabinet

The cabinet shown in Fig. 14 has been found to be particularly suitable for the RCA Types LC1A and 515S1 mechanisms. The loudspeaker mechanisms are designed to be flush mounted with the face of the cabinet. Mounting the loudspeaker mechanism so that the front of the cone coincides with the face of the cabinet eliminates resonant and antiresonant effects which occur when there is a cavity in front of the mechanism. The cabinet is equipped with a port which may be used to accentuate the low frequency response if this type of characteristic

is desired. The cabinet is lined with sound absorbing material, 1" thick, for the purpose of reducing standing wave systems within the cabinet which would react upon the loudspeaker and thereby produce a nonuniform response characteristic.

Loudspeaker Characteristics

The response frequency characteristics of the RCA LC1A loudspeaker mechanism, mounted in the cabinet of Fig. 14 and with the port opened and closed, is shown in Fig. 15B. It will be seen that uniform response can be obtained over the range from 40 to 15,000 cycles.

The directional characteristics of the
(Continued on page 140)

Fig. 14. Front, plan, and side views of the cabinet for housing reproducing system.

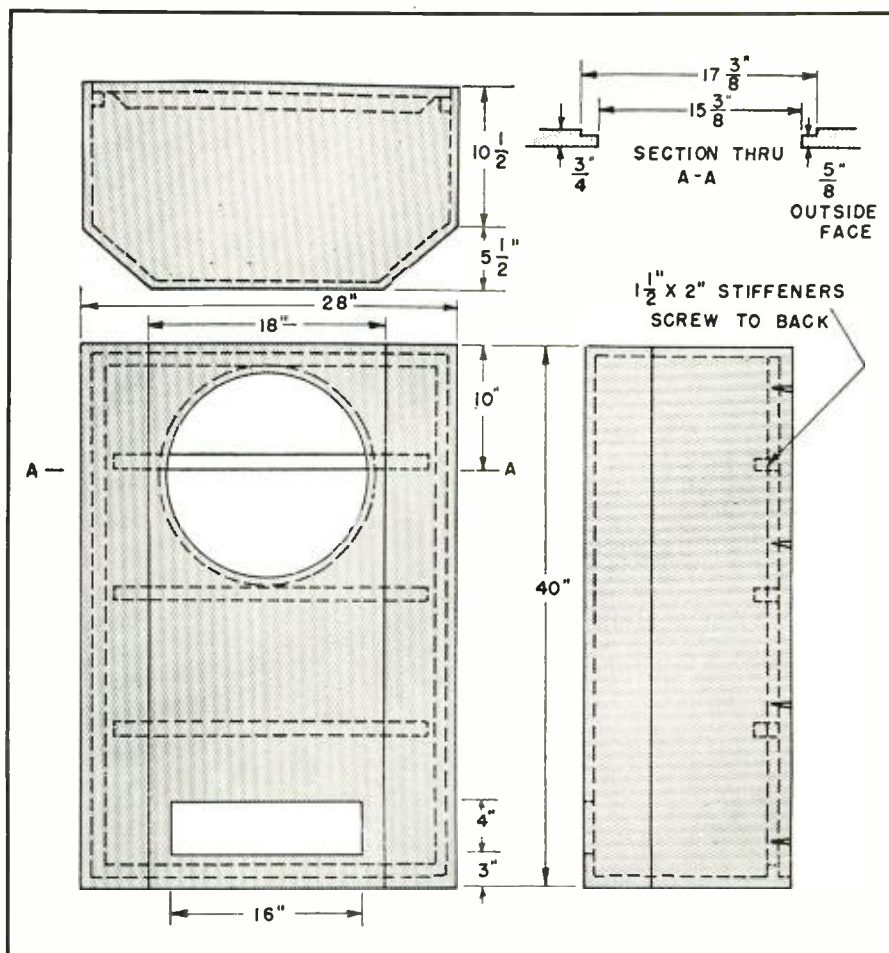

An ELECTRONIC LOSS COMPRESSOR



Parts required to build the single tube volume compressor circuit.

By

E. C. MILLER* and TAD JONES†

Basic circuit diagram of a new volume compressor using only one dual-triode tube. A deluxe model is also covered.

THIS article and the accompanying photographs describe and illustrate several units incorporating a new volume compressing circuit. This new unit requires only two tubes and is capable of 20 db. compression from 100 to 10,000 cycles with a change in output of ± 1 db. over that range of input amplitudes and frequencies. The secret of its operation lies in the fact that the tube does not amplify, but instead is used merely as a variable resistance which is controlled by the amplitude of the input signal. This circuit, recently developed by Northwest Radio Consultant Service, permits constant output from amplifiers or test equipment where size, weight, or cost precludes the use of the common types of compressors.

Fig. 1A shows what is perhaps the simplest method of volume compression, where the input signal is recti-

Fig. 1. (A) Circuit diagram of a simple method for obtaining volume compression. (B) The equivalent circuit.

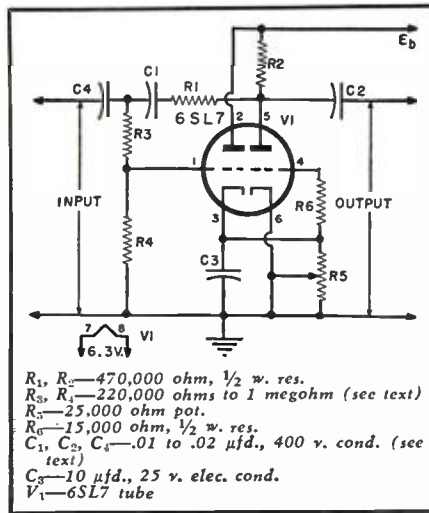
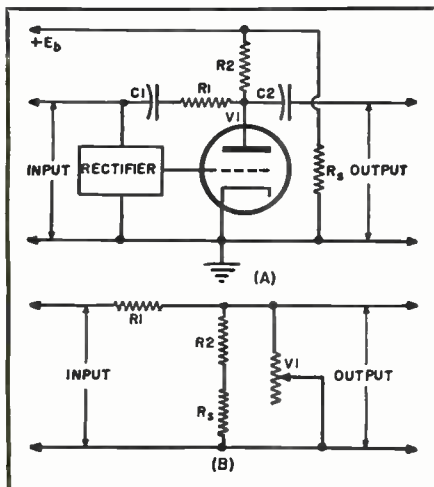

Fig. 2. Circuit diagram of a single dual-triode volume compressor unit.

fied and the developed d.c. voltage is applied to the grid of V_1 . As the signal increases in amplitude, the positive voltage on the grid increases, reducing the effective plate-cathode resistance of V_1 . Fig. 1B shows the equivalent circuit of Fig. 1A. It can be seen that if R_1 is large and is nearly equal to R_2 plus R_s , and if the resistance of V_1 is made to vary over a wide range, the output signal can be held constant with considerable changes in input signal.

For linear compression it is necessary that the effective resistance of V_1 must vary logarithmically with respect to the applied signal voltage. In order to accomplish this, many things must be considered: First, the value of R_2 , the plate load resistor, and R_s , the plate supply impedance at the frequency being considered, must be such that when combined with the plate resistance of V_1 , the output will be reduced by the ratio of the increase in

input amplitude. If the change in V_1 resistance were linear, this could only be accomplished for a small ratio of change, perhaps 3 or 4 db. It is evident then, that the change in V_1 resistance must approach the log of the change in input signal if the circuit is to compress to a constant output over an input range of 15 or 20 db. This could, of course, be accomplished by using logarithmic rectification with the necessity of further complicating the circuit.

By the use of high impedance cathode detection, and the proper selection of R_6 in Fig. 2, logarithmic change is accomplished in the plate current of V_1 by the grid current drawn through R_6 .

The complete theoretical design of this circuit is beyond the scope of this article, but for use at audio frequencies, the ratings of the components can be easily determined. C_1, C_2 and C_4 can be of the values usually used for coupling condensers such as .01 or .02 μ fd. The other component parts are dependent upon the type of tube used, so for our design we will use a 6SL7GT. With this tube, which has low plate current, a plate load resistor of 270,000 to 680,000 ohms may be used. A value of 470,000 ohms may then be expected to give nearly optimum results when used at R_2 . As noted earlier in this article, R_1 should equal R_2 . The actual values of R_3 and R_4 aren't as important as the fact that they should be of equal value and be somewhere between 220,000 ohms and 1 megohm each. The logarithmic network (C_3, R_5 , and R_6) can be calculated when the family of grid current curves is available, the lowest applied frequency is known, and several other factors are determined, but suffice it to say that with a 6SL7GT tube, R_6 should be 15,000 ohms, R_5 about 25,000 ohms maximum, and C_3 about 10 μ fd. The values indicated will produce a unit capable of 15 db. compression.

(Continued on page 110)

* Chief Engineer, Northwest Radio Consultant Service, Havre, Montana.
 † Chief Engineer, Radio Station KAVR.

Your Stake In The

COLOR DECISION

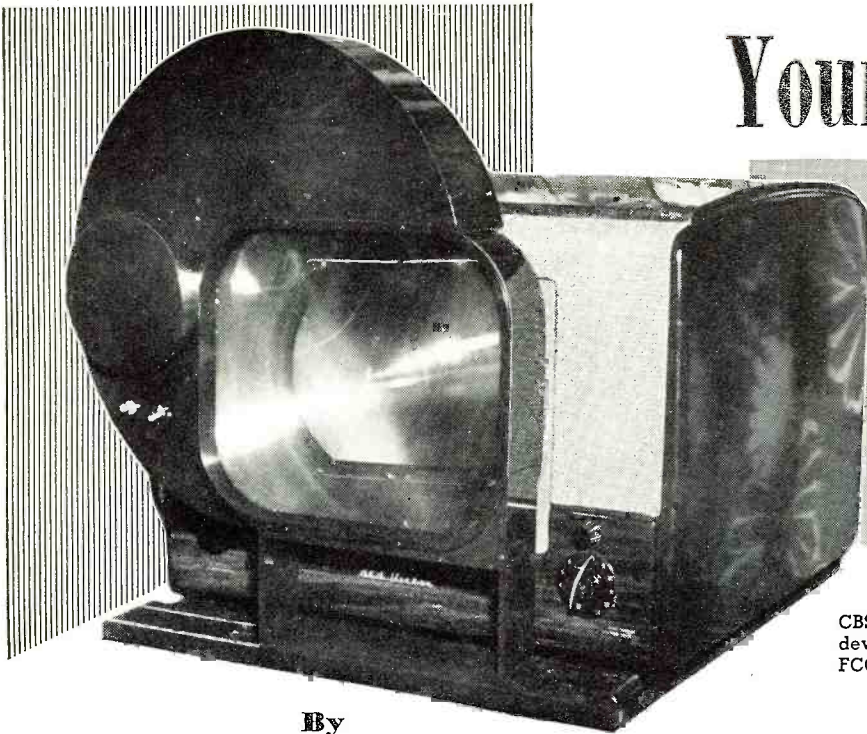

CBS's color converter developed for early FCC color hearings.

By

MILTON S. KIVER

Pres., Television Communications Institute

The non-compatibility of the CBS system presents new problems for you, whether a set or shop owner.

WHAT may well be one of the most important decisions in the field of communications was handed down by the Federal Communications Commission on September 1, 1950. This was the long awaited FCC report on Color Television—a report that was preceded by two years of acrimonious hearings. In brief, the FCC indicates that it definitely favors the *CBS* system over the *RCA* or *CTI* systems. In the Commission's own words, "the *CBS* system produces a color picture that is most satisfactory from the point of view of texture, color fidelity, and contrast."

The decision, while not final, is the first definite word advanced by the FCC on color and may well represent the essence of the final decision.

In view of this inclination by the FCC toward the *CBS* color system, it is only natural to wonder how the adoption of this system will affect those who own sets now, those who service TV sets, and those who manufacture them. Each has a very substantial stake in the future of television and obviously this future lies with color television. For those readers not familiar with the details of the FCC report, reference should be made to "Spot Radio News" on page 16 where a detailed account of the report is given.

The choice of the *CBS* system came as a distinct surprise to many radio-men, especially in view of the fact that it is not compatible with the present black-and-white system. It will be re-

membered that much of the argument during the color hearings centered about two words: compatibility and adaptability. A color system is said to be compatible with the present black-and-white system if the color broadcast could be received and viewed on a black-and-white set without any circuit changes. Of course, the picture seen would be black-and-white, but it would contain all the detail of the color picture. The *RCA* and *CTI* systems fall within this category.

An adaptable color system is one whose programs could be viewed on black-and-white sets only after certain changes were made in the exist-

For a complete review of the

FCC COLOR DECISION

see

SPOT RADIO NEWS, Page 16

ing sets. The *CBS* system falls into this class. Because *CBS'* line frequency (29,160 lines-per-second) and field frequency (144 fields-per-second) differ from the line and field frequencies employed in current black-and-white receivers, *CBS* programs could not be received on the sets now in use without a change in circuitry.

Now, what does the adoption of the *CBS* system mean to you, Mr. Set Owner? Present sets coming off the production line are designed to oper-

ate at a horizontal line frequency of 15,750 cycles-per-second and a field frequency of 60 cycles-per-second. Since these values differ appreciably from those found in the *CBS* system, certain changes would have to be made in your set before you could view *CBS* color programs even in black-and-white.

Your next question, of course, is: "How much would such a change cost?" The exact answer to this question cannot be given at this time because no such conversions have been made to date. FCC engineers have devised a circuit which shows what additional components would be needed and the cost of the parts alone runs between \$10 and \$17 depending upon whether manual or automatic switching is desired. To this figure would still have to be added the cost of labor. A tentative estimate might place the complete cost of conversion somewhere in the neighborhood of \$35 to \$40.

If, in addition, you wished to receive the color programs in color, the cost would rise considerably because now a motor and a color wheel (plus associated parts) would also have to be added. Some current industry estimates place this cost as high as \$150; others say that \$100 or perhaps slightly less will do the trick.

While we are on the subject of set conversion, here is one very important point to keep in mind. As the *CBS* system now stands, it cannot be used with picture tubes having diameters greater than 12½ inches because the color wheel would then become too large and unsightly. That means that if your present set has a picture tube larger than 12½ inches, it cannot be converted readily to receive color programs in color!! In time, it is hoped that a color tube will be available which will permit direct-viewing of *CBS* color pictures without a color

(Continued on page 126)

A 3-Channel UNITARY LOUDSPEAKER

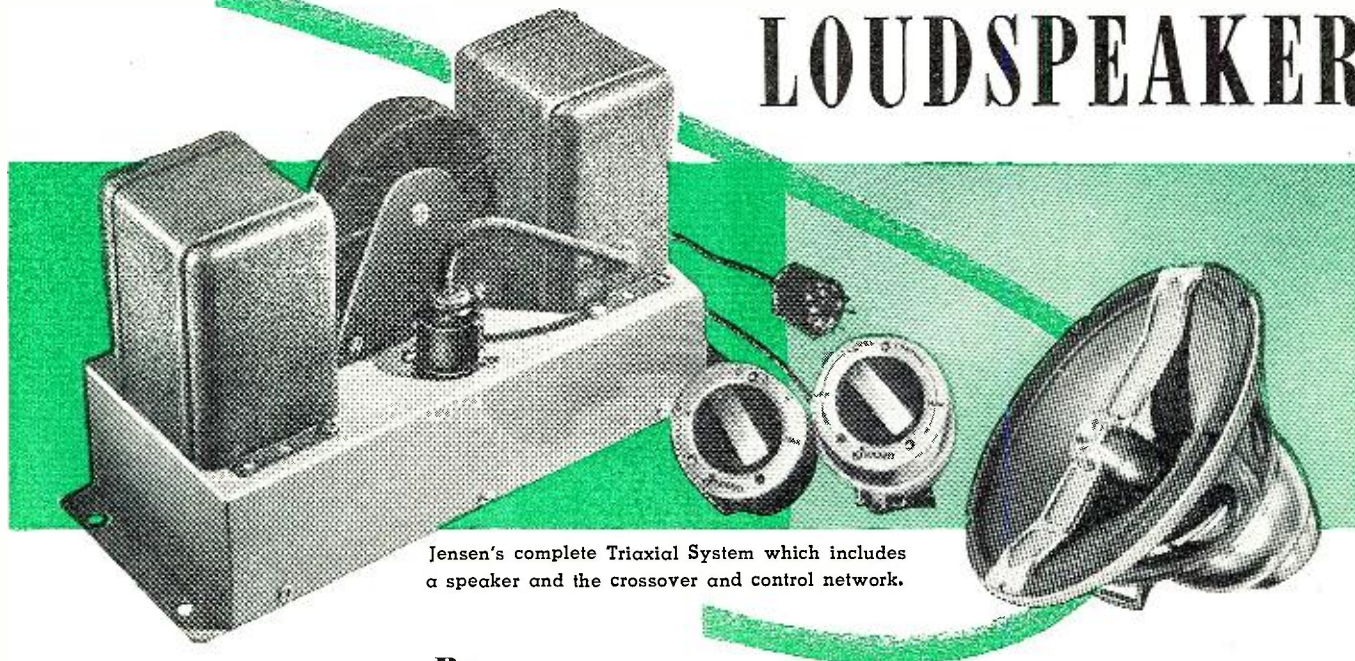

Jensen's complete Triaxial System which includes a speaker and the crossover and control network.

By

D. J. PLACH & P. B. WILLIAMS

Physicist

Senior Eng.

Jensen Manufacturing Company

Performance details on the new Jensen G-610 Triaxial speaker and its associated networks.

WE ARE now in a new era of sound reproduction and radio transmission as a result of intensive research toward the development of better audio equipment. This trend has necessitated the development of improved loudspeaker systems capable of faithfully reproducing the bandwidth that has been made available by microphones and electrical equipment of advanced design. The *Jensen Manufacturing Company*, anticipating the continuation of the improvement trend, in 1948 launched an intensive research program to develop a loudspeaker for critical high quality applications. No restrictions were set on design or manufacturing cost, with the exception of ultimate size. The unit was to be compact, unitary, and suitable for mounting in enclosures ordinarily used for high quality reproducers. Many theoretical and subjective considerations led to the choice of three channels constituting the loudspeaker to be known as the G-610 Triaxial.

Laboratory tests have shown that a band from 40 to 15,000 cycles will transmit the full frequency range of music with good fidelity. The higher frequencies are necessary to bring out the fine overtone structure of musical instruments. Response curves themselves are by no means a complete

measure of the performance of a loudspeaker. These curves are a guide in the development of loudspeaker systems when interpreted by trained acoustical engineers. Among many factors which are not apparent on axial sound pressure response curves are; spatial distribution, transient response, and harmonic and intermodulation distortion.

These factors, in conjunction with the frequency response, affect the subjective performance. Even though loudspeakers have similar response curves, it is a matter of common experience that they do not sound alike. Considerable differences in sound quality can be attributed to the other factors mentioned. To a large degree,

these considerations determine choice of crossover frequencies in multi-channel systems.

Spatial distribution, sometimes called polar behavior, must be uniform at various angles from the axis of the speaker. If the polar pattern is irregular, the response balance will change as the listener moves off axis. A more desirable condition exists if the over-all pressure drops off axis while uniform response is maintained. Polar behavior of a conventional cone type loudspeaker is poor at high frequencies, while non-directional at low frequencies where the wavelength is large compared to the diameter of the cone. It has been shown that for a 12-inch loudspeaker in which the cone is assumed to act as a rigid piston over the entire range, axial sound pressure response must be raised 18 db. at 5000 cycles in order to maintain constant total radiation. If the speaker is designed this way, it becomes overly bright on the axis. If, on the other hand, a flat response on the axis is desired, the total radiation characteristic falls off by 18 db. at 5000 cycles, as illustrated by Fig. 1. This gives an indication of the polar sharpening that may be expected with a single cone. The use of elements such as directors, fins or other masses mounted upon the cone do not compensate for the definite limitations in performance of a single cone. Such elements, which actually add no true radiating area when fastened to the cone, can only add mass to the motor system which will only reduce efficiency and high frequency response. The polar behavior can be altered to some extent by proper processing of

Fig. 1. Response of single cone speakers.

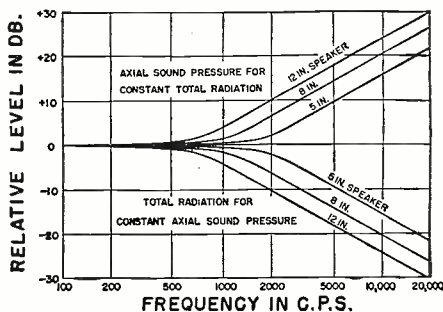

the cone, with corrugations to vary the radial stiffness, but generally not to the degree necessary for highly critical applications. The best practice involves use of compression type driver units operating into properly designed horns for wide angle radiation at high frequencies.

Another major problem in high quality systems is distortion of both harmonic and intermodulation types. Intermodulation distortion is especially serious, since it results in sum and difference frequencies which are not harmonically related to the fundamental tone, and therefore can be especially displeasing to the ear. There are several sources of distortion in cone speakers. One cause is cone breakup at higher frequencies due to use of light cones without sufficient rigidity to suppress spurious modes of vibration. In this case, the whole cone does not move as a piston, and objectionable subharmonic modes are generated. Proper cone processing and sufficient cone mass are used to reduce flexing during operation. While this helps to decrease breakup difficulties, a better method in high quality systems is to restrict the operating range of the loudspeaker. In a woofer unit, the choice of a low crossover frequency is indicated.

Other forms of distortion can be caused by movement of the voice coil into regions of non-uniform flux density. The remedy here is proper design of the magnetic structure and voice coil so that the product of flux density and voice coil conductor length is a constant even at large operating amplitudes, as has been done in the G-610 low frequency channel.

The suspension system must be correctly designed in order to avoid non-linear stiffness effects which give rise to harmonic distortion. At the resonant frequency of the moving system, mechanical impedance reaches a minimum and the cone attains its maximum movement. Greatest distortion accordingly occurs at this frequency, because around this region the suspension system is the controlling factor. Over-all effect on the performance of the speaker can be minimized by placing the resonance of the loudspeaker at as low a frequency as possible, consistent with axial constraint necessary for stability. Use of a compliant cone annulus and a large spider help to lower the resonant frequency. Some loudspeakers are designed with non-linear suspension systems for the very purpose of giving rise to high distortion which may give greater apparent loudness. Yet on critical listening over a period of time, it can be seen that this type of loudness boost is not desirable, as the sound is characterized by "muddiness."

It is also possible by use of magnetic fields of low energy levels, and more so in the case of speakers coupled to amplifiers of high internal impedance, to produce a false bass response due to undamped vibrations of the cone. The resulting "hangover" effect pre-

vents clean bass response. In some cases, damping is attained by use of solutions giving soft, absorbent coatings at the cone annulus. The better method is through use of magnetic damping of the vibrating system. This method, while costly, gives better damping characteristics over the whole frequency range, in contrast to selective damping effects from coatings. High magnetic energy required for good magnetic damping, in addition to minimizing spurious modes over the entire operating band, and improving transient performance, results in higher loudspeaker efficiency as well.

These considerations served as a guide in the development of a woofer for the G-610 Triaxial. Incorporated in this channel are a magnetic circuit providing 30 million ergs energy from a 6½ pound Alnico V magnet, and an unusually large voice coil, three inches in diameter. The extremely high magnetic efficiency achieved makes the choice of amplifier internal impedance non-critical from the standpoint of loudspeaker damping.

A moderately stiff 15 inch diameter cone minimizes breakups even at high power levels over its operating band. The breakup problem would not be serious, however, because of the low crossover frequency of 600 cycles used, beyond which energy is transferred to other channels. A heavy machined aluminum cone housing carries the iron structures for the three channels.

Numerous possibilities were investigated for high frequency reproduction, including secondary radiators such as thin metal domes coupled to the woofer voice coil. Investigation of many commercial adaptations of these domes disclosed spurious modes

of response and poor transient characteristics. While this method is common to lower priced loudspeakers and perhaps satisfactory in narrow range systems, it was considered highly unsatisfactory for a high quality reproducer.

Two additional horn type driver channels were designed to complete the coverage of the desired range, for it is not theoretically or experimentally possible to cover the full auditory range satisfactorily from 600 cycles up with only one channel. The requirements for efficient reproduction over a wide bandwidth in the upper register are contradictory. At frequencies approaching the lower limit of 600 cycles, a sturdy moving system and large air chamber clearances are necessary, whereas at the high frequencies, where the program energy is less and amplitudes are smaller, small clearances and very light moving systems are required for efficient operation. These opposing requirements dictated the use of two channels to cover the range from 600 cycles up. Horn type drivers were chosen in preference to direct radiator, or cone type, units, for a number of reasons:

(1). For a given magnetic energy, the additional loading given by a horn makes it possible to obtain much higher efficiency.

(2). Properly designed horns give good loading down to cut-off frequency, thereby reducing diaphragm movement necessary for a given amount of radiated power. This eliminates distortion effects caused by motion of the voice coil out of the magnetic gap and by non-linear stiffening

(Continued on page 120)

Rear view of the complete G-610, three-way Triaxial System. Network chassis is shown mounted on baffle but may be located on side or bottom of cabinet. The high frequency and level controls may be mounted flush on the outside of the cabinet housing the unit.

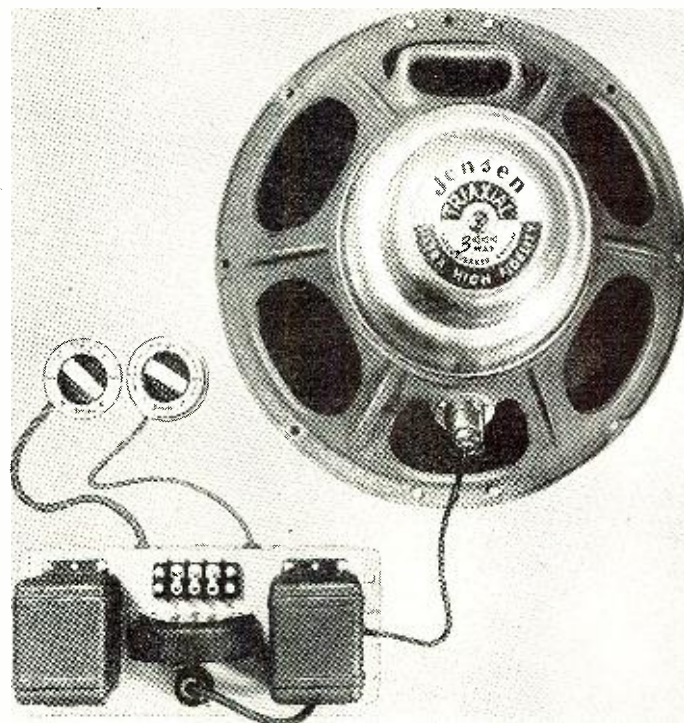

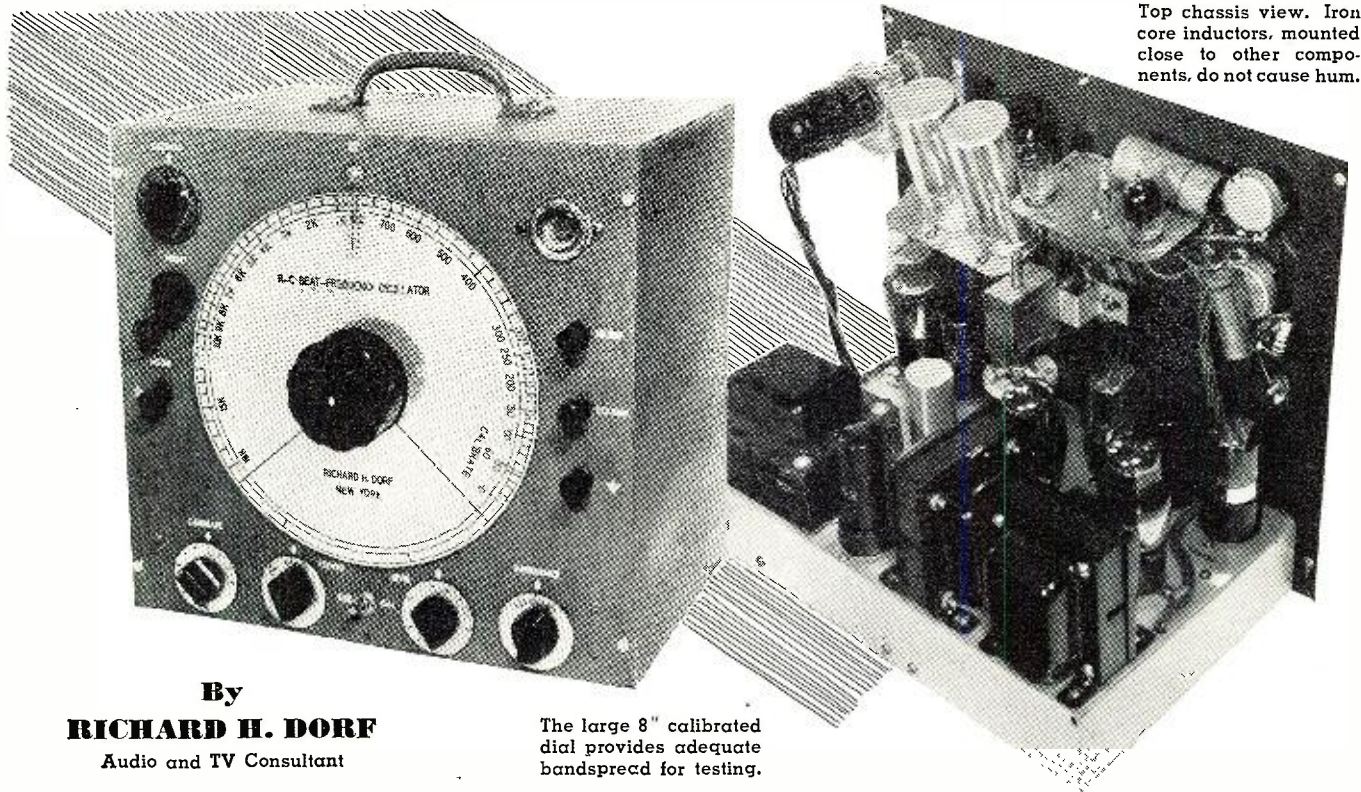

Top chassis view. Iron core inductors, mounted close to other components, do not cause hum.

By
RICHARD H. DORF
 Audio and TV Consultant

The large 8" calibrated dial provides adequate bandspread for testing.

An RC Beat-Frequency OSCILLATOR

Excellent frequency stability and constant output characterize this unit which covers 5-19,000 cycles.

IT WOULD seem that in this day and age the perfect audio test generator should have been invented long ago. Certainly many magazine articles have been written on various versions of the two principal types—the beat-frequency oscillator and the RC-tuned fundamental-frequency generator. In their common forms, however, neither of these two types solves the problem entirely, at least for general experimental work.

Certain fundamental problems defy simple solution. An r.f. test generator, for instance, need rarely cover a range in frequency of more than two or three to one, which is easily done with a standard tuning condenser. When the range is greater, switching is used; since no single use for such a generator involves more than a single range, switching causes no problem of continuity between ranges.

In audio, on the other hand, any one use of the oscillator usually calls for tuning over the entire range between at least 50 and 10,000 cycles, a range of 200 to 1, and sometimes from

20 to 20,000, which is 1000 to 1. No wonder there is a problem!

The most popular oscillators today use Wien bridge circuits which oscillate at the fundamental frequencies. Few tuning condensers, however, have ranges of capacitance greater than about 10 to 1, so three switched bands are necessary. Of itself this would not be a serious fault but it introduces at least one other fault—discontinuity in the output level. When, for instance, 200 cycles is at the upper end of the first range and the switch is turned to the second range to continue the run, the output level usually changes abruptly. Unless the output is measured continuously, therefore merely switching bands introduces an error in a frequency run. In the best of the RC oscillators, level is usually kept in line within ± 1 db. or so. But because it is likely to change most with a change from minimum to maximum tuning capacitance, switching bands like this makes an abrupt change in the graph line of the readings and is confusing.

A second fault of the RC unit is the fact that it rarely has sufficient overlap. Experimenters must often determine quickly the resonant frequency of some network or other. If that frequency happens to fall at the extreme end of one range there must be a continual switching of ranges plus precise measurement and recording of output from the tested circuit before the peak-output frequency is apparent.

A third shortcoming of the Wien bridge oscillator is very apparent in some poorly built instruments. Because of either a large time constant or a slow-heating stabilizing lamp in the automatic gain control circuit, the operator must wait for a second or two each time he changes frequency for the output to come up or down to normal. The effect is made worse by poor adjustment of the feedback control, an adjustment which is extremely touchy at best. No one adjustment, in any case, is satisfactory at both the highest and the lowest frequencies.

Beat-Frequency Oscillators

The beat-frequency oscillator does not have the faults of the fundamental-frequency type. Its continuous tuning allows for no discontinuities in level and, at least in a well built unit, the level is inherently constant since the variable oscillator is tuned over only a small range—never even as much as 2 to 1. Obviously, range overlap is no problem as there are no ranges to switch. It may have a slightly less perfect output waveform, however, due to distortion in the detector. It is more elaborate than the RC oscillator, requiring at least three

tubes against a minimum of one duotriode for its "opponent."

The principal disadvantage of the beat-frequency oscillator is the fact that a small percentage drift in the frequency of either of the r.f. oscillators causes a very large drift in the a.f. output. Some means of calibration must be built in and the instrument may not be used for some minutes after it has been turned on.

As a construction project, the beat-frequency oscillator is much less popular than the RC unit mainly because it requires such good shielding. Two oscillators operating near the same frequency tend to lock in step. Without good shielding, the oscillators would lock suddenly when they came as close together as a few hundred cycles (assuming they were operating at around 100 kc. or more), which means that to obtain low-frequency a.f. output, shielding must be better than the average constructor cares to worry about. Placement of components also affects locking. As in the RC oscillator a variable condenser (usually two) is needed and it is subject to strays and hum pickup.

Combining the Two Types

In an effort to design a generator which would overcome some of the problems of both types the writer combined them so as to make use of the best features of each. The result is a beat-frequency oscillator having continuous frequency coverage but with no coils to radiate r.f. and consequently no shielding.

Performance-wise, this RC-tuned beat-frequency oscillator covers a range from 10 to a little over 19,000 cycles. The easily reproducible tuning dial has an effective scale length of 18 inches so that all frequencies may be read easily. Though 10 cycles is the lowest calibration, the unit reaches about 5 cycles with good stability, showing how little locking effect there is between the two oscillators. Output level is flat without measurable variations over the entire range and waveform appears excellent on the oscilloscope, though no harmonic distortion measurements have been made. The frequency becomes stable enough to use after three to four minutes of warmup and does not drift noticeably after seven or eight minutes.

Circuit Design

The particular instrument constructed by the writer is illustrated in the photographs and diagrammed in the schematic. It is more elaborate than some constructors will find necessary, but the essential elements—a three-tube circuit—may be used with or without additional embellishments.

The two high-frequency oscillators which beat to produce the audio resultant are V_1 and V_6 in the diagram, a pair of 6SN7GT's. Each oscillator requires a grand total of only two resistors and no condensers, excluding the tuning components.

The cathodes of the two triodes in each 6SN7GT are tied together and grounded through a common resistor. The first triode acts as a cathode follower coupling the signal to the cathode of the second triode, which is a grounded-grid amplifier. This arrangement is sometimes used as a phase inverter in normal amplifiers and that is exactly why it is used here. The voltage amplification required for a Wien bridge oscillator is only 3, which could be adequately supplied by a single triode; but the amplifier output must be in phase with the input so an inverter is necessary. This is the simplest possible circuit.

For the fixed oscillator, the frequency-determining network consists of C_2 and the combination of R_1 and R_2 in series, plus the parallel com-

bination of C_1 and R_4 . A small section of the series resistance (R_3) is made variable for calibration purposes. The tuning components in the variable oscillator are C_{11} , R_{26} , R_{28} , C_{16} , and R_{29} . In this case, most of the series resistance is variable (R_{28}) to provide a main tuning control.

The cathode and plate resistor for each oscillator is so proportioned as to just allow oscillation, which makes for maximum stability and minimum distortion. The oscillators operate at about 60 kc. The variable tunes up to about 80 kc., a total range of only 1.4 to 1, so feedback conditions do not change appreciably over the entire audio range and no stabilizing lamp is necessary. When R_{28} is at minimum resistance the output waveform of the variable oscillator is

Complete schematic diagram of the RC beat-frequency oscillator. Oscillator tuning components may require some trimming which may be determined by experimentation.

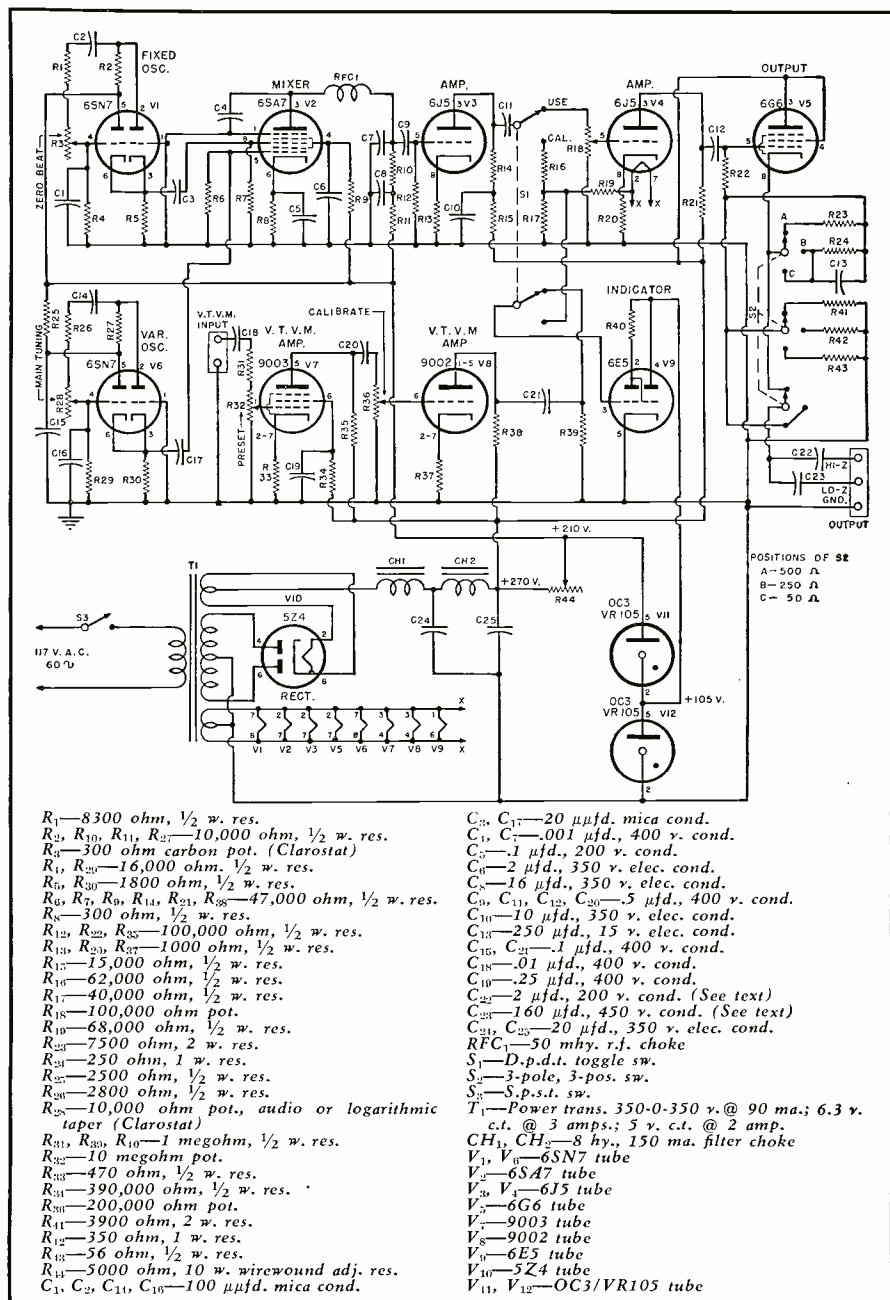

- R_1 —8300 ohm, $\frac{1}{2}$ w. res.
- $R_2, R_{10}, R_{11}, R_{12}$ —10,000 ohm, $\frac{1}{2}$ w. res.
- R_3 —300 ohm carbon pot. (Clarostat)
- R_4, R_{20} —16,000 ohm, $\frac{1}{2}$ w. res.
- R_5, R_{30} —1800 ohm, $\frac{1}{2}$ w. res.
- $R_6, R_7, R_8, R_{11}, R_{21}, R_{28}$ —47,000 ohm, $\frac{1}{2}$ w. res.
- R_9 —300 ohm, $\frac{1}{2}$ w. res.
- R_{12}, R_{22}, R_{23} —100,000 ohm, $\frac{1}{2}$ w. res.
- R_{13}, R_{24}, R_{27} —1000 ohm, $\frac{1}{2}$ w. res.
- R_{17} —15,000 ohm, $\frac{1}{2}$ w. res.
- R_{18} —62,000 ohm, $\frac{1}{2}$ w. res.
- R_{19} —40,000 ohm, $\frac{1}{2}$ w. res.
- R_{25} —100,000 ohm pot.
- R_{26} —68,000 ohm, $\frac{1}{2}$ w. res.
- R_{27} —7500 ohm, 2 w. res.
- R_{28} —250 ohm, 1 w. res.
- R_{29} —2500 ohm, $\frac{1}{2}$ w. res.
- R_{30} —2800 ohm, $\frac{1}{2}$ w. res.
- R_{31} —10,000 ohm pot., audio or logarithmic taper (Clarostat)
- R_{32}, R_{33}, R_{34} —1 megohm, $\frac{1}{2}$ w. res.
- R_{35} —10 megohm pot.
- R_{36} —470 ohm, $\frac{1}{2}$ w. res.
- R_{37} —390,000 ohm, $\frac{1}{2}$ w. res.
- R_{38} —200,000 ohm pot.
- R_{39} —3900 ohm, 2 w. res.
- R_{40} —350 ohm, 1 w. res.
- R_{41} —56 ohm, $\frac{1}{2}$ w. res.
- R_{42} —5000 ohm, 10 w. wirewound adj. res.
- C_1, C_2, C_{11}, C_{16} —100 μ fd. mica cond.
- C_3, C_{17} —20 μ fd. mica cond.
- C_4, C_7 —0.01 μ fd., 400 v. cond.
- C_5 —1 μ fd., 200 v. cond.
- C_6 —2 μ fd., 350 v. elec. cond.
- C_8 —16 μ fd., 350 v. elec. cond.
- $C_9, C_{11}, C_{12}, C_{20}$ —5 μ fd., 400 v. cond.
- C_{10} —10 μ fd., 350 v. elec. cond.
- C_{13} —250 μ fd., 15 v. elec. cond.
- C_{15} —1 μ fd., 400 v. cond.
- C_{18} —0.1 μ fd., 400 v. cond.
- C_{19} —25 μ fd., 400 v. cond.
- C_{22} —2 μ fd., 200 v. cond. (See text)
- C_{23} —160 μ fd., 450 v. cond. (See text)
- C_{24}, C_{25} —20 μ fd., 350 v. elec. cond.
- RFC₁—50 mah. r.f. choke
- S₁—D.p.d.t. toggle sw.
- S₂—3-pole, 3-pos. sw.
- S₃—S.p.s.t. sw.
- T₁—Power trans. 350-0-350 v. @ 90 ma.; 6.3 v. c.t. @ 3 amps.; 5 v. c.t. @ 2 amp.
- CH₁, CH₂—8 hy., 150 ma. filter choke
- V₁, V₆—6SN7 tube
- V₂—6SA7 tube
- V₃, V₄—6J5 tube
- V₅—6G6 tube
- V₇—9003 tube
- V₈—9002 tube
- V₉—6E5 tube
- V₁₀—5Z4 tube
- V₁₁, V₁₂—OC3/VR105 tube

somewhat distorted but it has much less effect on the detector output than the fixed oscillator, whose output remains nearly harmonic-free.

The detector or mixer is a 6SA7. The input signal coupled to the No. 3 grid (that from the fixed oscillator) has a much greater effect on the plate current than that coupled to grid No. 1 (the variable oscillator).

The plate circuit of the 6SA7 contains an LC filter which attenuates the r.f. and allows the audio to pass. C_1 and C_7 with the 50 mhy. r.f. choke make up a low-pass constant-k filter which cuts off at approximately 30 kc. R_{10} is the plate load resistor with R_{11} and C_8 a decoupling filter. Audio output is taken through C_9 .

The parts discussed above are the heart of the instrument and may be used with any kind of amplifier.

The instrument in its final form includes a cathode-follower-output amplifier and a vacuum-tube voltmeter as well as a built-in power supply.

The amplifier has three stages, the first two of which, V_3 and V_4 are conventional triode voltage amplifiers (a single 6SN7GT could have been used). The output level control R_{18} is between the two. Unbypassed cathode resistors help in keeping the input resistance high and capacitance low to avoid frequency discrimination.

The output tube was chosen for its ability to deliver a usefully high voltage when used as a cathode follower. An ordinary low-level triode would do just as well if the cathode follower fed a high impedance. In this case, however, the oscillator was designed to feed 500/600 lines and 250 and 50 ohm amplifier inputs. When a cathode follower is correctly matched to and loaded by such low impedances, the feedback in terms of actual voltage is so low that the permissible input voltage and gain are greatly reduced unless plate-supply voltage is boosted considerably.

Distortionless output voltage is limited to about 4 volts into 500 ohms, 0.6 volt into 250 ohms, and 0.5 volt into 50 ohms. These values are sufficiently high for almost any purpose.

The cathode follower circuit is different for each of the three impedances. In all cases the grid return is placed between two series cathode resistors since the optimum bias resistor is smaller than the total necessary load resistance for 500 ohms and larger for the lower impedances, in which case it is bypassed by C_{13} . Output is taken directly from the cathode for 500 ohms and from the junction of the two resistors for the lower values, though it could have been taken from the cathode for all loads.

S_2 is a wafer switch whose three positions select the correct resistors and feed output through C_{23} to the low-impedance terminal. C_{23} is made up of a pair of Cornell-Dubilier UP-type condensers, each of which is a dual 40 μ fd. at 450 working volts. Since the cathode voltage (d.c.) is 130 in the 500-ohm position it is essential that d.c. leakage be low to avoid transferring current to the device under test. These condensers were chosen for low leakage after a number of tests. Current transfer into a 500 ohm (resistive) load is less than 50 microamperes.

High-impedance devices may be fed by the same cathode follower with the advantage that the cathode impedance keeps the line impedance so low that hum and noise pickup is negligible even when the distance between the oscillator and the device is great. In this case, however, no d.c. at all may usually be tolerated, as it might change the bias if applied to a grid. For this reason, a high-impedance output is provided by taking signal from the cathode through a 2 μ fd. metalized paper condenser to a separate terminal. The 2 μ fd. value makes it possible to feed impedances as low

as 5000 ohms without any falling off of bass down to the oscillator's minimum calibrated frequency of 10 cycles.

When feeding a high-impedance device, the impedance switch is set on the 500 ohm position. Maximum undistorted output voltage is about 28, open circuit, and only slightly less when loaded down to 5000 ohms. The three stages are so designed that the volume control may be opened fully to obtain this voltage.

Indicator Circuits

At least one indicator circuit is needed in any beat-frequency oscillator—for calibration—and an additional one, a vacuum-tube voltmeter, is provided here to measure the output of devices under test. Both use a 6E5 electron-ray tube.

Except on extremely expensive oscillators, an indicator that calibrates by showing when the two oscillators are at the same frequency is unsatisfactory because the indication is too broad for accuracy. Despite the usual shielding the oscillators will lock when very close. It is more satisfactory to calibrate by setting the instrument for an audio output of 60 cycles and beating that with the power-line frequency, which is very accurate in most localities.

The simplest circuit is used. S_1 , a d.p.d.t. toggle switch is shown in the diagram in the "Use" position. To calibrate, it is thrown to the "Calibrate" position. The output of V_5 then goes to R_{16} and R_{17} in series to ground as a voltage divider. At the junction of the two resistors is connected one side of the center-tap-grounded filament winding of the power transformer. The same junction is connected through a section of S_1 to the grid of the 6E5. When line and oscillator audio frequencies are equal (adjustment is made by the zero beat control of the fixed oscillator) the 6E5 shadow angle stays constant. With very small differences it opens and closes very slowly, while at other frequencies it appears to remain closed.

The vacuum-tube voltmeter does not read directly in volts but merely in decibels above and below a variable (uncalibrated) reference. The v.t.v.m. input terminals are connected across the correctly terminated output of the device under test. The preset potentiometer is then set so that with R_{36} at the zero-decibel mark the 6E5 shadow just closes. For each change in v.t.v.m. input level caused by frequency discrimination in the tested unit, R_{36} is reset so that the shadow again just disappears and the decibels gain or loss is read from the R_{36} dial.

The minimum signal handled by the voltmeter is less than 10 mv., so that the lowest-level stages can usually be measured. High-level devices merely require that the R_{22} setting be low. Input resistance of the meter circuit is 11 megohms with sufficiently low

(Continued on page 165)

Under chassis view. Although wiring appears crowded, the unit functions satisfactorily.

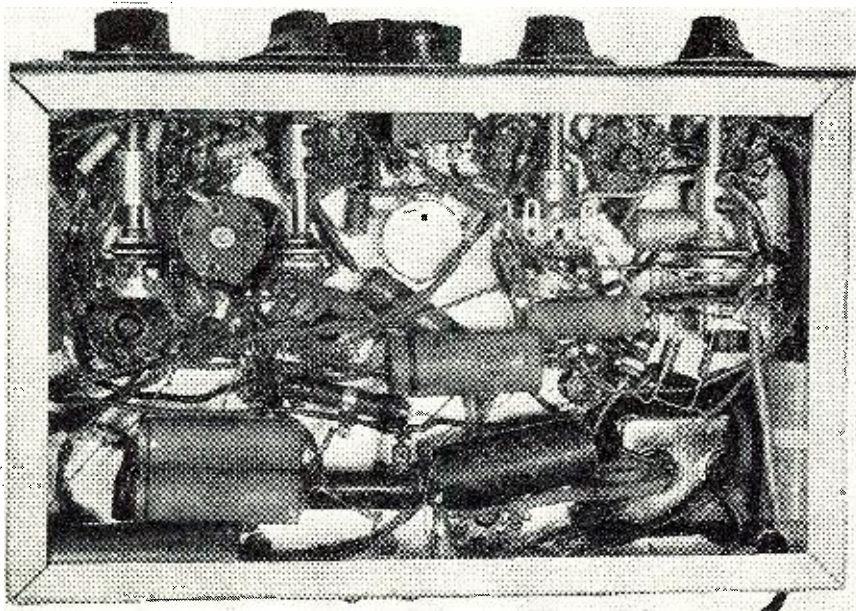

An Unusual

PUBLIC ADDRESS SYSTEM

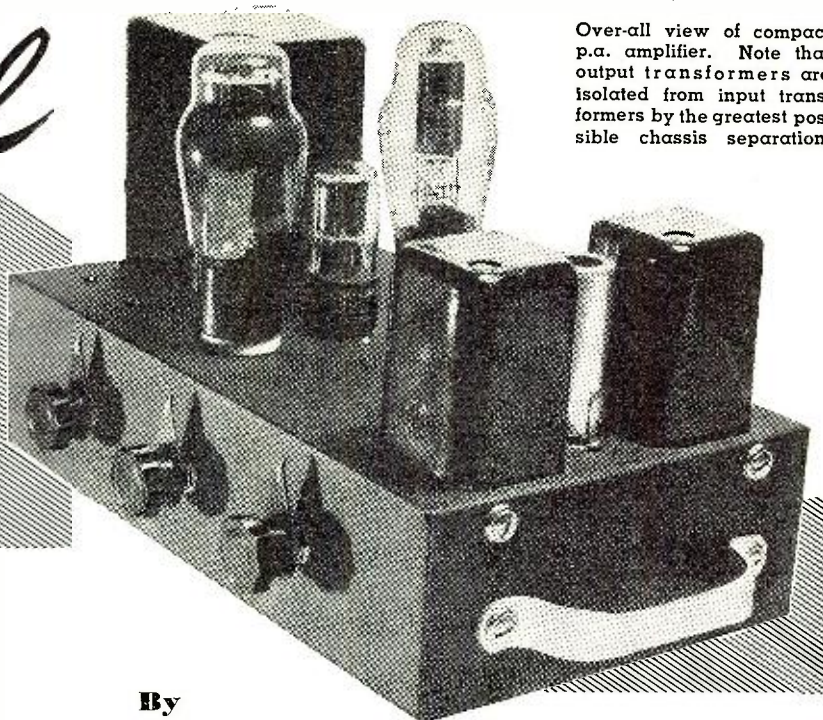

Over-all view of compact p.a. amplifier. Note that output transformers are isolated from input transformers by the greatest possible chassis separation.

By

GLEN SOUTHWORTH

This 20 watt amplifier features voltage multiplier power supply and two low impedance input circuits.

IN JUDGING the over-all utility of a particular electronic device it is often necessary to consider factors other than strictly electrical characteristics. This seems to be particularly true of equipment such as public address amplifiers, which may be used for a number of different purposes in a wide variety of situations. In the case of equipment which is continually being moved from one location to another, physical characteristics are of definite importance, with size, weight, and mechanical strength being some of the primary considerations. In the case of the conventional public address amplifier, several factors tend to produce undesirably large physical dimensions. One of these factors is the need for isolating input and output stages in a high gain system. This is often done by resorting to mere spatial separation rather than by the use of shielding. Another factor is the bulk of the amplifier components themselves. Providing adequate area for sufficient heat radiation, thus increasing the service life of the various amplifier components is an additional requirement. Another possibility is that a particular amplifier may contain circuit elements not strictly necessary for a particular application.

In practice, a worthwhile reduction in size and weight, without sacrifice of electrical performance, may be achieved by minimizing the above mentioned factors whenever possible, consistent with other considerations such as reliability of performance and ease of maintenance, both of which are important factors in professional public address work.

In conventional amplifiers a large part of the weight, bulk, and heat radiation comes from the power supply. In some cases the power supply alone may occupy half of the amplifier chassis. In addition, the mounting of heavy components, such as the power transformer, on the chassis may lead to severe mechanical stress which, in the case of a light chassis, may lead to a rupture of spot welds as well as

undue strain on circuit wiring or other components.

A very worthwhile reduction in physical dimensions, heat radiation, and weight, as well as somewhat greater economy, can be obtained through the use of selenium rectifiers in a voltage multiplier circuit. In the circuit diagram shown, a simple voltage tripler is sufficient to supply 360 volts d.c. to the plates of push-pull 6L6's operated in class AB₁. Basic power supply requirements are, therefore, reduced to three 150 ma. selenium rectifiers, three electrolytic filter condensers, and a small 6.3 volt filament transformer. Likewise, extra ruggedness and longer life are obtained by eliminating the conventional rectifier tube.

The output voltage of a multiplier system will depend upon the load resistance and the size of the condensers used in the multiplier circuit. With the 30 μ fd. condensers shown in the schematic the tripler will supply 100 milliamperes at approximately 360 volts to the 6L6 plates. Under maximum sine wave signal the voltage dropped to about 330 volts. The regulation could be improved by use of larger condensers but it was noted that under conditions of maximum undistorted output for complex sounds, such as speech, that the plate voltage change was much less. If desired, however, an additional voltage doubler stage might be included to supply well regulated voltage to the screen grids of the 6L6 tubes.

It should be realized that the volt-

age multiplier type of power supply has the disadvantage that one side of the a.c. line is connected to the electrical ground of the circuit. This is a situation found in many pieces of electronic equipment, particularly small radio sets, but it is wise to take precautions to prevent possible shock or short circuits. The simplest way of doing this is to insert the a.c. plug into the outlet in such a position as to connect the chassis to the neutral side of the line. Where polarized outlets are not available, polarity may usually be determined with a small neon testlight. One of the testlight leads is grasped by the bare fingers and the other lead touched to some exposed portion of the chassis. If the chassis is "hot," body capacity will make the testlight glow, and when the a.c. plug is reversed the glow should disappear. An additional precaution is taken in the amplifier circuit shown, *i.e.*, that of isolating the chassis and microphone inputs from the electrical ground of the circuit. The only connection between the chassis and the rest of the circuit is a .25 μ fd. condenser which greatly reduces the possibility of accidental short circuit but may lead to a somewhat greater hum level in some installations.

Turning to the power output stages of the amplifier, a number of factors might be noted. A high-grade output transformer was used, both from the standpoint of greater efficiency and the availability of a clean, wide range signal, thus making the amplifier useful for a number of applications. An-

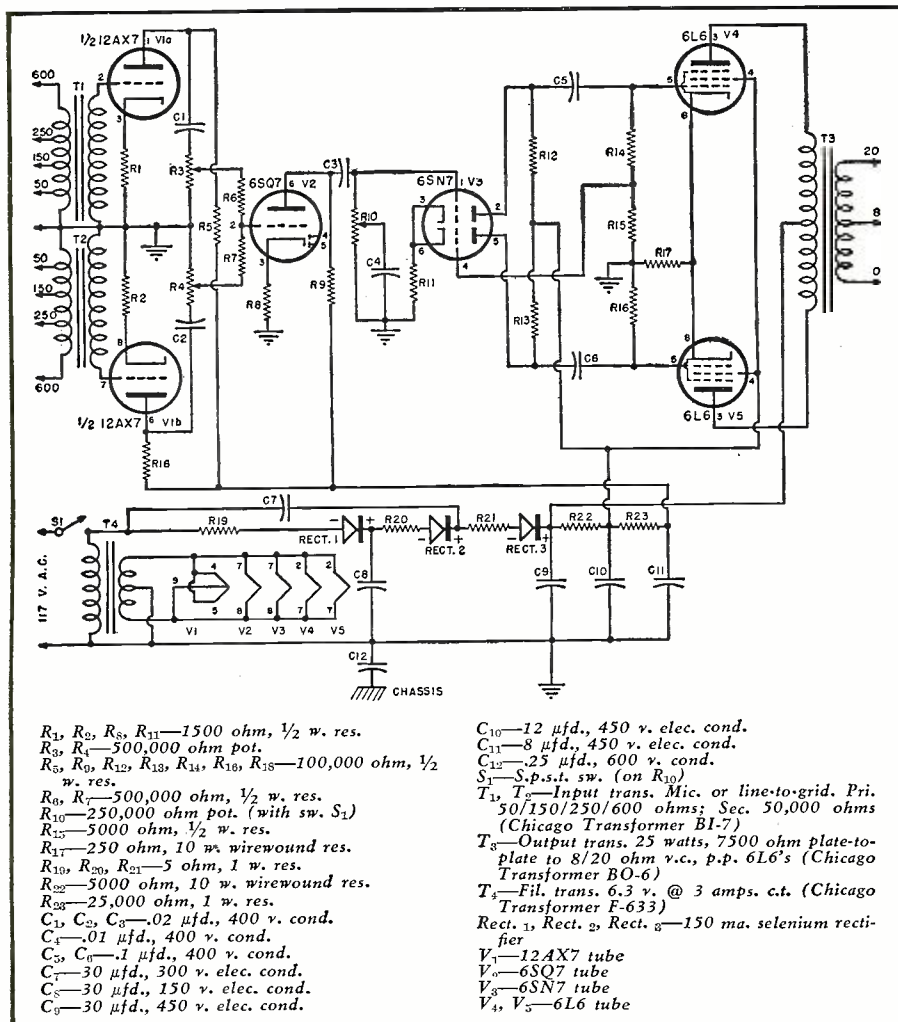

Complete schematic of the twenty-watt p.a. amplifier and its associated power supply.

- R₁, R₂, R₈, R₁₁—1500 ohm, 1/2 w. res.
- R₃, R₄—500,000 ohm pot.
- R₅, R₉, R₁₂, R₁₃, R₁₄, R₁₅, R₁₈—100,000 ohm, 1/2 w. res.
- R₆, R₇—500,000 ohm, 1/2 w. res.
- R₁₀—250,000 ohm pot. (with sw. S₂)
- R₁₇—5000 ohm, 1/2 w. res.
- R₁₆—250 ohm, 10 w. wirewound res.
- R₁₉, R₂₀, R₂₁—5 ohm, 1 w. res.
- R₂₂—5000 ohm, 10 w. wirewound res.
- R₂₃—25,000 ohm, 1 w. res.
- C₁, C₂, C₃—.02 μfd., 400 v. cond.
- C₄—.01 μfd., 400 v. cond.
- C₅, C₆—.1 μfd., 400 v. cond.
- C₇—30 μfd., 300 v. elec. cond.
- C₈—30 μfd., 150 v. elec. cond.
- C₉—30 μfd., 450 v. elec. cond.

- C₁₀—12 μfd., 450 v. elec. cond.
- C₁₁—8 μfd., 450 v. elec. cond.
- C₁₂—25 μfd., 600 v. cond.
- S₁—S.p.s.t. sw. (on R₁₀)
- T₁, T₂—Input trans. Mic. or line-to-grid. Pri. 50/150/250/600 ohms; Sec. 50,000 ohms (Chicago Transformer BL-7)
- T₃—Output trans. 25 watts, 7500 ohm plate-to-plate to 8/20 ohm v.c., p-p. 6L6's (Chicago Transformer BO-6)
- T₄—Fil. trans. 6.3 v. @ 3 amps. c.t. (Chicago Transformer F-633)
- Rect. 1, Rect. 2, Rect. 3—150 ma. selenium rectifier
- V₁—12AX7 tube
- V₂—6SQ7 tube
- V₃—6SN7 tube
- V₄, V₅—6L6 tube

other circuit feature of considerable importance is the use of low value grid resistors for the 6L6's. This tends to greatly reduce the buildup of small grid potentials on the order of a volt or so which may tend to block low level signals, giving the reproduction a "mushy" effect. The difference in quality between .1 and .5 megohm is often readily noticeable in listening tests, with considerable amounts of inverse feedback being required to achieve comparable cleanness of reproduction with the higher value of grid resistance. Another factor of interest is that due to the high quality of the output transformer employed, no condenser is used between the plates of the 6L6's. This is desirable in that any appreciable capacity across the plates may produce impulse distortion with the result that needle scratch or similar sounds are made more audible. Likewise, ceramic sockets are used in the output stages in order that the full output of the amplifier may be used without danger of high voltage arc-over to ground.

It should be noted that no cathode bypass condensers are used in the amplifier circuit. In the voltage amplifier stages these are optional, but in the output stage it was considered worthwhile to eliminate the cathode

bypass in order to generate a certain amount of out-of-phase third harmonics, which tend to make the system less critical with regard to "breaking up" when used at maximum levels, such as may be required in public address service.

The phase inverter used is of conventional design, while the mixer stage uses a single triode instead of the more common dual tube arrangement. In this type of mixer the outputs of the two volume controls are fed into the same grid through 500,000 ohm isolating resistors. This has the slight disadvantage that the gain is somewhat reduced and increasing the gain of one channel will tend to increase the gain of the other channel by a small amount. However, a circuit of this nature has the advantages of simplicity and lower distortion as well as the fact that high frequency response is virtually the same at all settings of the volume control, due to the relatively small grid-to-ground capacity. Due to the series grid resistances in the mixer circuit, a small amount of constant high frequency roll-off may be present. In critical applications this may usually be compensated for by partially bypassing the 6SQ7 cathode resistor with a condenser of from .01 to .05 μfd. capacity.

One of the most interesting features of this amplifier is the use of low impedance input circuits. Long used in broadcast equipment, low impedance inputs have several decided advantages over the high impedance circuits found in virtually all conventional public address amplifiers. In the case of crystal microphones, a load impedance of from two to five megohms is usually recommended. As a result, hum pickup is often a problem, due either to loosely braided microphone cable or a fraction of an inch of exposed grid lead. Likewise, in the case of the crystal microphone, the output diminishes as the cable length increases, thereby making adequate, hum free gain a problem where long cables are involved. The high impedance magnetic microphone is usually not quite as critical as regards hum pickup, working satisfactorily into a load resistance of the order of 100,000 ohms. However, high frequency response may suffer severe attenuation where reasonably long cable lengths are used and due to the fact that it is an inductive device, r.f. pickup may represent a problem in some installations. As both types of microphones are of relatively high impedance and the associated circuits are susceptible to unwanted noise pickup, high level mixing and switching is almost a necessity.

The use of low impedance circuits eliminates all of the previously mentioned drawbacks. Microphones may be placed at any distance desired without undue hum or noise pickup, frequency attenuation, or power loss. Circuit switching or mixing may be accomplished at the amplifier input if desired and small amounts of unshielded lead usually do not represent serious sources of hum or noise pickup. High quality input transformers were used in the amplifier design shown and provided input impedances of from 50 to 600 ohms, thereby matching virtually all commercial and broadcast type low impedance microphones as well as being readily adaptable for use with broadcast remote lines.

Nearly all broadcast microphones are of the low impedance variety so that the prospective user should have little difficulty in obtaining as high a quality microphone as desired to go with the amplifier. Likewise, it might be noted that many inexpensive, high impedance, dynamic microphones are actually of low impedance construction, but with a small matching transformer inside the case. If wished, this can be disconnected from the circuit and the microphone used as a straight low impedance unit.

The experimenter should find low impedance input circuits of definite value in work with electromagnetic devices such as pickups and microphones. The use of low impedance circuits means that matching coils can be easily wound with a relatively small number of turns. An example of this is the case of a G-E variable reluctance pickup with an open wind-

ing. The old winding was removed and replaced with a few hundred turns of larger wire. Extremely good performance was obtained when the pickup was connected across the 50 ohm tap of the input transformer and previous problems such as supersonic feedback and high frequency resonance caused by cable capacity were eliminated.

The accompanying photographs show the general parts layout used by the author. Input transformers should be mounted as far away from the output and filament transformers as practical in order to minimize electromagnetic coupling. Electrolytic condensers should be isolated from possible sources of heat for maximum life expectancy although the over-all heat radiation of this amplifier appears to be much lower than that of conventional designs. The entire amplifier was constructed on a 12" by 7" by 3" chassis, however, the resourceful constructor could probably reduce these dimensions through use of smaller, less expensive audio transformers, and miniature tubes.

It should be noted that the close spacing of parts in high gain amplifiers is not necessarily undesirable. Long audio leads should be avoided, if possible, as these provide extra capacity coupling between the chassis and other parts of the audio circuit. As 10,000 c.p.s. is defined as a low radio frequency an appreciable field may exist around the wiring in high level stages and, though the 60 cycle hum pickup of unshielded leads may be very low, difficulties may still be experienced due to supersonic feedback in wide range equipment. A chassis bottom plate is desirable as it tends to reduce the possibility of supersonic pickup from long, unshielded, speaker wires.

Small Jones plugs were used for both the input and output sockets, both from the standpoint of flexibility derived from the additional contacts and for the ease in which the circuits may be isolated from the chassis, thus reducing trouble from ground loops. It will be noted that the output transformer used has only 8 and 20 ohm taps. This, however, is sufficient to match one to four 8 ohm speakers and when speaker cables of less than one hundred feet in length are used this does not cause a serious power loss.

The over-all performance of the amplifier built by the author was very satisfactory and it contains a number of features which should be of interest to the high fidelity enthusiast as well as the public address operator. Exceptionally clean response was obtained from high quality tape recordings as well as other input sources although no inverse feedback was used in the amplifier. Maximum sine wave output is 20 watts at 60 cycles, while over-all frequency response is from 30 to 20,000 c.p.s.

A few general comments might be included for the benefit of those in-

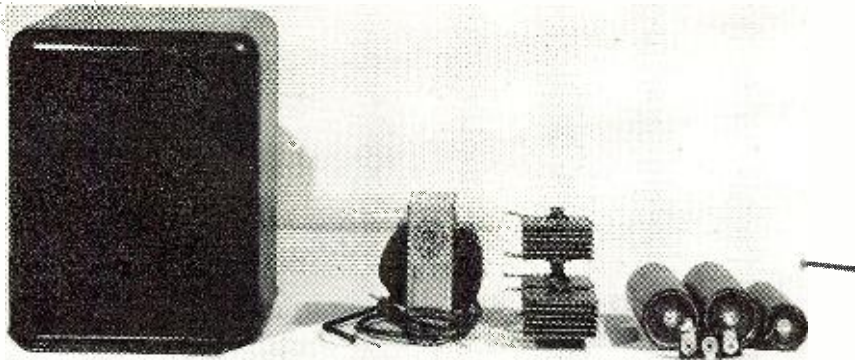

Comparison between the size of a good grade 120 ma. power transformer and the complete voltage tripler power supply used in this p.a. amplifier unit.

experienced in public address work. Although a 20 watt system may produce high sound levels in the average living room, it should be realized that apparent loudness is a function of room size and the sound absorption of the walls, furniture, and number of people in the room. Similarly, clearness or intelligibility is a function of the noise level of a given location as well as the frequency characteristics of the acoustics. The result of these factors is that careful speaker placement and high acoustic output are necessary for good coverage under some circumstances. In speaker placement it is usually desirable to use two speakers placed some distance apart and above the heads of the audience if there is any likelihood that part of the group will be standing or sitting in front of them. Similarly, high efficiency loudspeakers are often desirable in order to make the best use of the electrical output of the amplifier. In connection with this, it might be noted that sometimes small diameter loudspeakers, with relatively light cones and magnets, show surprising efficiency. One cluster of four 6 inch speakers produced about twice the out-

put of a heavy-duty 12 inch speaker in comparison tests. Likewise, where intelligibility is of primary importance, low frequency reproduction usually represents wasted power and attenuation below 500 cycles may be desirable.

Often the poor quality of public address sound draws unfavorable comment. Assuming that a good grade of audio equipment is used, the principal problem remaining is that of adequate monitoring. Through use of the long microphone cables, made possible by low impedance circuits, the amplifier and controls may be located back in the audience, making possible accurate adjustments of both volume and tonal balance.

Reliability and consistent performance are of prime importance to the serious public address operator since a single failure can disappoint a relatively large group of people and jeopardize his business reputation. In addition to the inherent advantages of the amplifier described in this article, the relatively small size and light weight should make it practical to take along a spare amplifier for emergency use when covering important events.

-30-

Under chassis view of p.a. amplifier showing parts layout and simplicity of wiring.

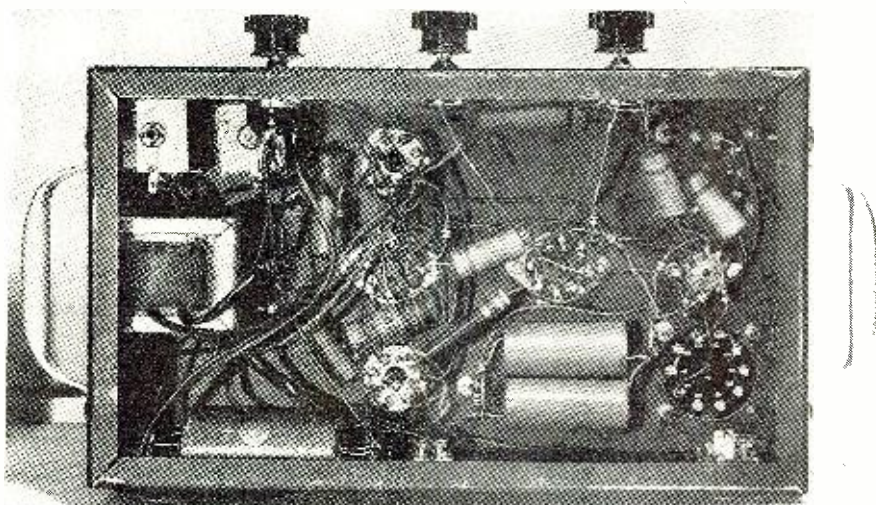



Fig. 1. Over-all view of the "Mobile Sound Studio."

SOUND ON WHEELS

By
LAWRENCE J. EPSTEIN
University Loudspeakers, Inc.

A MOBILE sound unit can be either a sideline, serving as a seasonal fill-in source of revenue for the local service technician, broadcast engineer, or ham; or it can be designed, constructed and operated as a genuine, year-round business venture. Often the difference lies only in attention to relatively minor details which increase the efficiency and dependability of the unit and its operation, and the addition or elaboration of services which make the unit truly versatile, flexible, and equal to almost any occasion.

Typical of what might be done along such lines, is the businesslike "Mobile Sound Studio" operated in the White Plains, New York, area by Jack Starr, an old-timer who really learned the hard way. "It's not how loud, but how reliable that counts," says Jack. That principle is apparent throughout the design of the "Studio." The amplifiers

Not just a p.a. system—it also features wire recorders and a 115-volt power plant for lighting purposes. Much of the equipment may be removed for use on indoor assignments.

and program equipment are standard, commercially available units which may be readily removed from the truck for use on indoor assignments. Auxiliary devices are also made from standard components, adapted in simple fashion to a particular application.

With the possible exception of the collapsible roof-top platform and the loudspeaker stand, which require a small welding machine, all equipment can be constructed and installed using ordinarily available tools.

To start with, a *Marmon-Harrington* Model DVL-4 (Indianapolis) truck was purchased because its features made it especially suitable for such work. Road clearance is only 14", and being a front wheel drive (60 hp. motor), the floor of the truck is completely flat since the customary propeller shaft is eliminated. There are 284 cubic feet of unobstructed loading space, with folding rear, side, and cab partition doors. The front half of the truck (cab) houses operating and control equipment, while the back portion holds the power supply, auxiliary, and emergency equipment as well as stowage. With six forward speeds and two reverse, the truck can creep at speeds suitable for parade participation, or as a mobile reviewing stand.

Power Plant

Perhaps one of the outstanding features of this unit is its complete self-

dependence for power, and its ability to adapt itself to a variety of changing situations. Sporting a 3 kva. gas-driven *Onan* Model W3S, a.c. power generator, the unit is capable not only of running a heavy load of electronic equipment, but will furnish spot and flood lamps (see the flood lamps mounted atop pipe on truck radiator, Fig. 1), auxiliary lighting equipment and appliances at remote locations, and has on several occasions furnished hot coffee to shivering politicians on cold November days! In fact, Starr offers his power plant facilities as an emergency lighting service which, more often as not, results in further use of the p.a. facilities for emergency direction. Lawn parties, and grand openings of commercial enterprises are other examples of p.a. work attracted by Starr as a consequence of his power plant capacity and auxiliary lighting equipment.

Fig. 3 is a block diagram of the power plant and associated equipment. The generator is self-starting, operating from the two six-volt storage batteries through the remote control "start-stop" switch located in the cab near the operator. To check the operation of the power plant, a meter panel, located at the rear of the operator (see Fig. 2) includes a 12 volt d.c. voltmeter, oil pressure gauge, d.c. ammeter, battery charge indicator and regulator, and, though not related, an

eight-day clock. A water temperature indicator is mounted alongside the panel.

Power Switch

The a.c. output of the generator is fed through a 30 ampere fuse to a *Cutler-Hammer* Model OO, C83-74 "quick make/break" d.p.d.t. handle-operated drum switch which ties the a.c. load of the unit to either the generator or an outside a.c. source. Whenever available, a line is run to the nearest commercial power outlet and fed to this selector switch through the lock-twist connector on the roof-top and through a 30 ampere fuse. Fuses used are the *Fusetron* delayed action type, so that momentary surge voltages will not interrupt service. The switch may be seen in Fig. 2 at the left side of the instrument panel. Instant switchover is thus made possible should the commercial power at the source tapped fail because of excessive load. All a.c. lines are polarized and each outlet marked for "grounded" side. When an external power source is used, the grounded side is determined by the simple light bulb method (with one side to earth, the outlet is probed for the "hot" side which will cause the light to glow). This assures consistency in grounding of electronic equipment and reduction of static charges which otherwise have a tendency to build up, causing shocks and hum.

Distribution of Load

A number of a.c. outlets and some ceiling lights are then directly fed from the power switch. Across the output are an a.c. voltmeter and ammeter. These serve to check loading condition, should a limit be necessary as a consequence of using an external power source, or to check the load on the generator.

Some devices are fairly critical when it comes to a.c. operating voltage, while others (such as turntables and recorders) require fairly accurate and stable frequency. For these reasons the line which feeds the amplifiers, turntables, and recorders first goes through a heavy duty *Variac* unit, with an output voltage indicating meter. A *J.B.T.* frequency meter is used to check the line, and should power be coming from the generator unit, the frequency can be adjusted for a given load by a knob control which governs the driver engine r.p.m.

Muffling Generator Noise

Since announcements, as well as recordings, are often made in the spacious cab, it was necessary to sound-proof the cab and as much of the truck as possible. The easiest way to do this was by enclosing the generator in a compartment lined with $\frac{3}{4}$ " *Celotex* and finished with pressed board. The rear of the generator may be seen in Fig. 2, a section of the enclosure having been removed. This muffled the engine noise considerably but presented a further problem in keeping

Wire Size B & S	SPEAKER TRANSMISSION LINE IMPEDANCE					
	4 Ohms	8 Ohms	16 Ohms	100 Ohms	250 Ohms	500 Ohms
14	125'	250'	450'	1000'	2500'	5000'
16	75'	150'	300'	750'	1500'	3000'
18	50'	100'	200'	400'	1000'	2000'
20	25'	50'	100'	250'	750'	1500'
% Power Loss	15%			5%		

Table 1. Chart showing the maximum practical speaker line lengths for sound installations.

the generator from overheating on hot days or in close quarters. A louvered air vent was installed facing the rear left wheel. A 1/10 hp. electric motor with an 18" bucket blade was then installed at the front of the enclosure, this motor deriving its power from the generator output. At least a 10% decrease in water temperature results from this forced air draft, which is then sucked in by the generator's own intake fan and the air pushed forward through the driver engine radiator and out the louvered air vent at the rear of the enclosure. This auxiliary cooling fan is turned on from the operator's position in the cab.

Should additional cooling become necessary, there is an auxiliary water-circulating centrifugal pump, driven by a 1/6 hp. electric motor, also deriving its power from the generator output, which is turned on from the cab. The gas engine uses a thermo-siphon water cooling system which depends upon water temperature for circulation. The pump produces circulation before permitting the water to reach the critical temperature, thus maintaining a low average water temperature. Although it would seem that engine efficiency should suffer, in practice these auxiliary devices have enabled the power plant to continue uninterrupted service for long periods

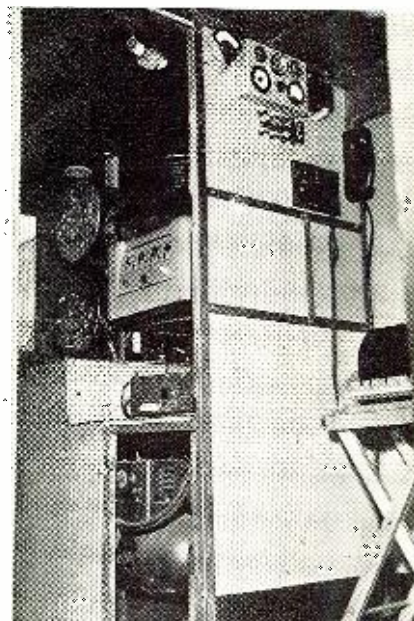

Fig. 2. Meter panel for checking operation of the truck's power plant. The panel includes a 12 volt d.c. voltmeter, oil pressure gauge, d.c. ammeter, battery charge indicator and regulator, and an 8-day clock.

of time under very trying conditions. As for fuel supply, the power plant itself holds five gallons of regular gaso-

Fig. 3. Block diagram of a typical power plant and its associated auxiliary equipment.

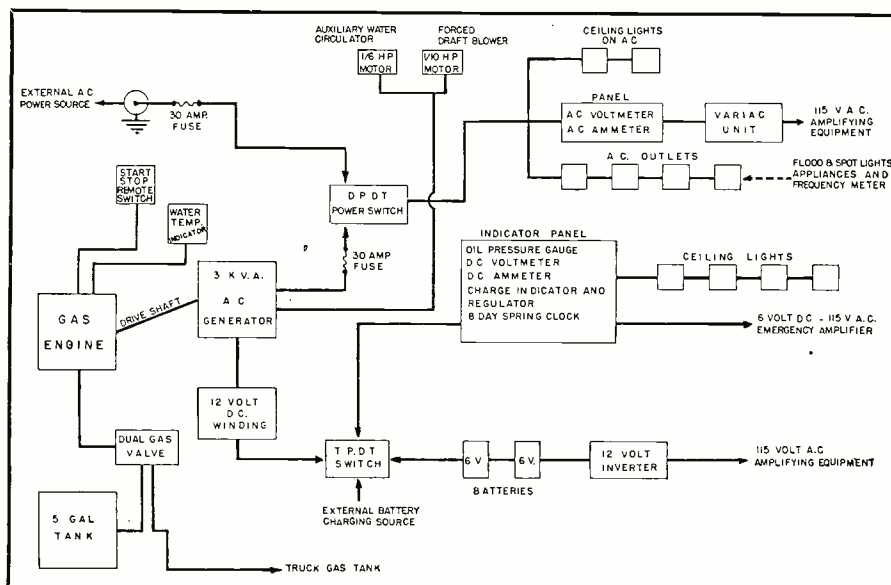
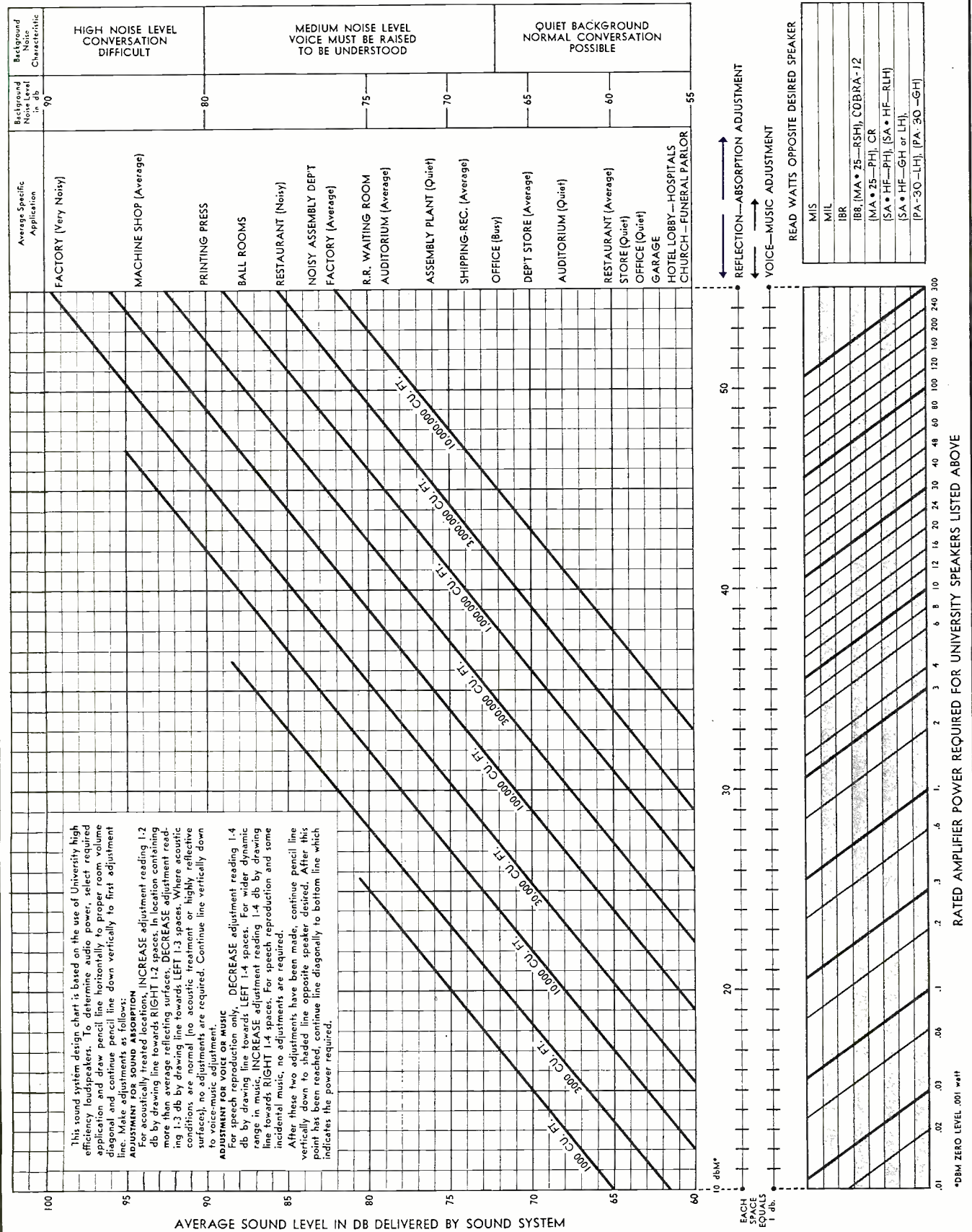

Fig. 4. Sound system design chart. Although designed specifically to be used with University loudspeakers it may be used with other comparable units.



line, enough for eight hours' operation at full load capacity. However, a dual valve is installed at the cab so that the operator can feed gas from the truck's tank to the generator, if need be!

Emergency Source

A twelve volt *ATR* inverter is also ready to swing into action should both a.c. power sources fail. The inverter is run off the same two 6-volt batteries which are used to start the generator engine. When the engine operates, it automatically charges these batteries from a secondary winding on the generator which delivers 12 volts. A t.p.d.t. knife switch (Fig. 2, just below the meter panel) provides various arrangements whereby the batteries may be charged from the generator or an outside source, used to start up the generator, or six volts tapped for direct operation of a 30 watt emergency amplifier, just in case the two a.c. power sources and the 12 volt inverter fail!

Loudspeakers

Fig. 1 shows a full view of the unit, with four *University* LH trumpets and SAHF driver units mounted at the corners, and *University* Cobra-12 wide angle speakers covering the mid-sections. When used with large trumpets the new Cobra-12 adds to the crispness and penetrating qualities of the over-all reproduction, as well as to fill in voids. As shown in the photograph, operation is set at 360° coverage. 180° coverage, at full strength, is accomplished by simply directing the two front LH trumpets straight forward and turning the two rear trumpets to face fore and aft, favoring the working side by about 15°.

The trumpets are mounted to the roof-top by a single bolt through the center hole of the "U" bracket, thus permitting simple adjustment of the trumpet direction. Vertical adjustment of the trumpets and Cobra-12 are, of course, also possible, so that the "throw" may be fixed as required. Vertical adjustment should be made to suit the size of the audience (working area) anticipated, directing the speaker axis to a point approximately $\frac{2}{3}$ the distance to be covered. Lines are brought into the cab by means of *Amphenol* feedthrough connectors, directly alongside the speakers.

Fig. 5 is a close-up of the loudspeaker stand. Again *University* Model LH trumpets are used, but this time with the Model PA-30 driver unit. There are 10 such stands, some accommodating three of the smaller PH trumpets and some for a single 6½ ft. air column GH trumpet. They are employed to cover vast areas which are too distant to be covered by the truck speakers alone. Due to losses which will be experienced with such long lines, the *University* PA-30 is used because the built-in multi-impedance line matching transformer facilitates operation of the transmission line at high impedances, to minimize the loss for a

given size wire. The chart of Table 1 indicates maximum transmission line lengths for various size wires and commonly required impedances.

Naturally, as the number of remote speakers used varies, the impedance selected at the driver varies, in order to maintain a proper match at the amplifier. Such change is readily accomplished at the base of the PA-30 driver unit which has an exposed weather-proofed terminal block, thus avoiding the need to make any internal driver connection changes.

However, in the case of the rooftop loudspeakers, the 16 ohm voice coil lines of the SAHF driver units and the 8 ohm lines of the Cobra-12 speakers are brought into junction boxes which contain a *University* #5408 multi-tap line matching transformer and selector switch. In addition to an "off" position, available impedances are 500, 1000, 1500, and 2000 ohms. Thus, if only the three speakers on one side of the truck are to be used, along with two LH/PA-30 loudspeakers at a remote location, and assuming that it is desired that the amplifier power be split evenly between the truck and the remote speakers, the following connections would be used:

(1) Speakers 1, 2, and 3 switched on, in the 1500 ohm positions. This equals 500 ohms. Speakers 4, 5, and 6 switched to "off."

2. The 1000 ohm terminals of the two PA-30 driver units paralleled and the resultant 500 ohm line run to the truck.

3. These two lines then are paralleled, resulting in 250 ohms which is then connected through the amplifier changeover switch to the 250 ohm output of the amplifier.

Any number of properly matched combinations are thus possible with a loudspeaker arrangement as provided by the equipment used by the "Studio."

As protection against lightning, the lines from the remote loudspeakers, when used, go first to a lightning ar-



Fig. 5. Closeup of loudspeaker stand.

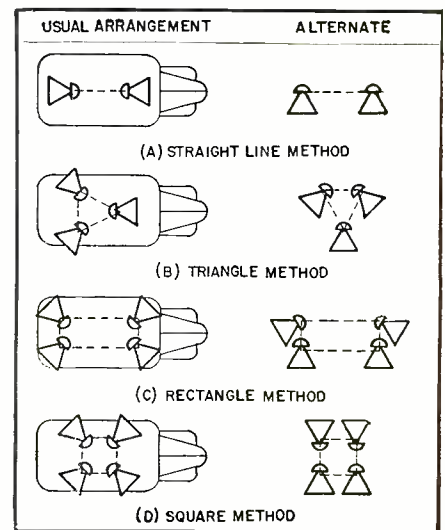
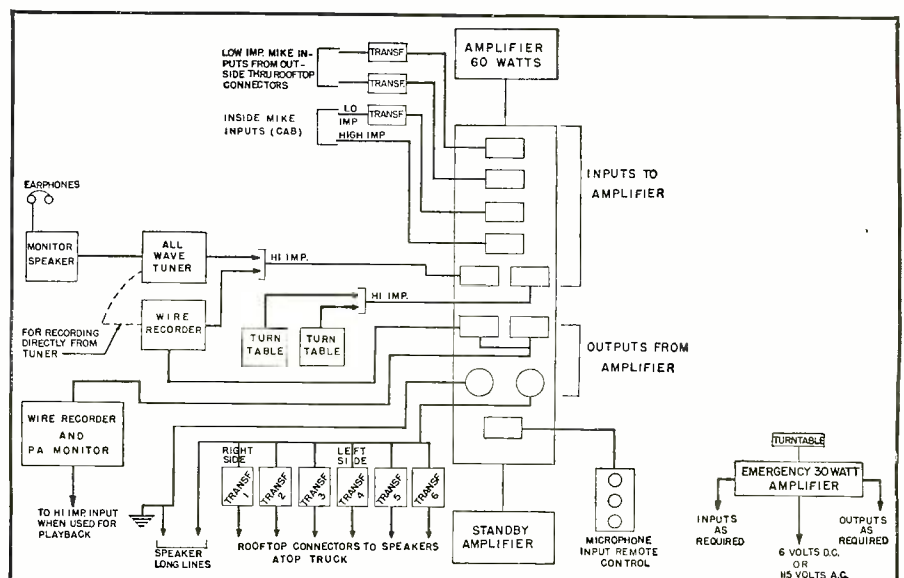

Fig. 6. Several common methods of positioning loudspeakers on the mobile sound unit.

rester before entering the truck. When external a.c. is used, the truck serves as ground, through the grounded side of the a.c. When the power plant is

Fig. 7. Block diagram of the instantaneous switching panel and associated equipment.



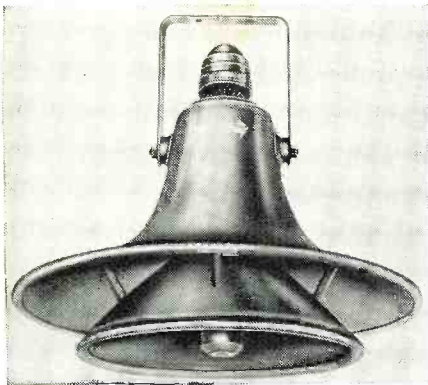

Fig. 8. University Loudspeaker, Inc.'s Model RLH radial reflex loudspeaker unit.

used, a ground stake is driven into earth or a line run to any nearby grounded metallic object.

Fig. 6 illustrates several common methods of positioning loudspeakers on mobile units. They provide a degree of necessary flexibility and may be used for most soundcasting applications. Naturally, the more speakers used to cover a given area, the higher will be the sound pressure at any one point. For example, alternate method "C" will certainly produce more sound for a 180° angle of dispersion than will alternate method "B." "B," of course, is obviously superior to "A."

Method "D" for 360° coverage is better than "C" because a more uniformly distributed sound pressure will result, but "C" will do a better job when only 180° coverage is required.

Method "B" is obviously a compromise between the two- and four-speaker systems. It will perform well for both 360° and 180° requirements.

More elaborate speaker layouts than illustrated are sometimes used, but more often than not they are designed to increase distance covering ability and to cope with special vertical propagation problems. Dispersion angle and low frequency cut-off ratings of projectors are an important factor in deciding which system should be used. These ratings are directly related to the length, flare, and mouth diameter of the projector. Contrary to what one might normally expect, the shorter, smaller trumpets have a wider dispersion angle than the larger projectors. Low frequency cut-off, a function of air column length and hence horn size, is of course lower for the larger projectors than for the small ones. Thus, there evolves a paradoxical situation where we must tolerate narrow dispersion angles for large projectors in order to obtain greater fidelity, while dispersion from the smaller trumpets, which have limited low frequency response, is relatively wide.

Re-examining the layout methods of Fig. 6, one can readily appreciate that to do a really good job, the four-speaker systems should be employed where the larger 4½' and 6½' reflex trumpets are required, the three-speaker method used for 3½' or 4½' reflex trumpets, and the two-speaker arrangement reserved for 2½'-3½' projectors. Where cost is of prime im-

portance, or a relatively small area is to be serviced, the larger trumpets can be used; or a radial reflex projector, such as the *University* RLH, can be suspended atop the vehicle to give uniform 360° propagation. When used with a Model 2YC adapter and two SAHF or PA-30 driver units, this single speaker will handle 50/60 watts of power with excellent fidelity. Sound pressure at any one point will be lower, however, than when a multiple speaker layout is used. Fig. 8 is an illustration of such type projector.

"How much power do I need?" is perhaps the most often heard question in this business. Much has been written regarding the subject, with the answer invariably being, "It all depends!" This goes without saying, but most successful sound trucks have been able to do a decent job with a good 60 watt amplifier and some top-notch loudspeakers. Merely as a guide, Fig. 4 is a chart which may be used for any type indoor or outdoor sound installation. Generally speaking, the sound pressure at any one point in an area covered, should not be less than 6 db. over the level of ambient noise reaching the same point. A leeway of 10-15 db. is preferable. The nature of the interfering noise will determine the level difference necessary. Adjustment of the frequency response of the system, using the amplifier tone controls, can be quite effective. Noise containing a heavy amount of the audio spectrum reproduced in the pro-

(Continued on page 190)

Fig. 9. The amplifiers used in the mobile "studio" operate on 115 volts a.c. and are placed at right of the truck operator.

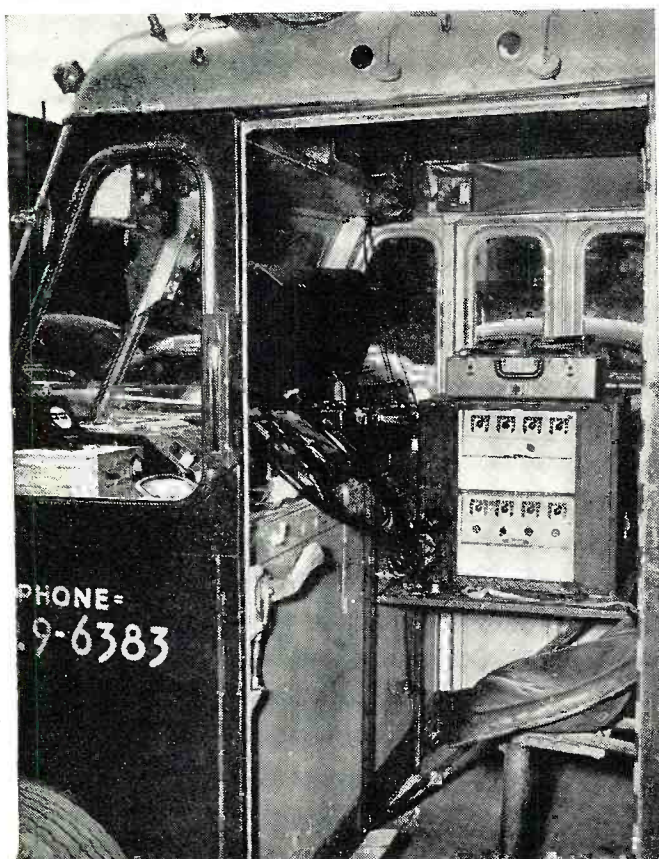
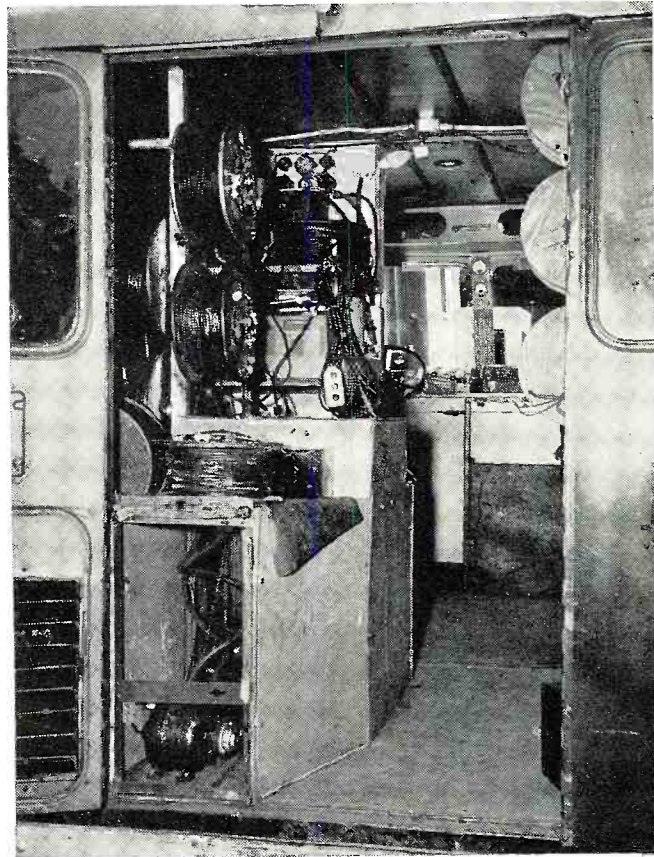

Fig. 10. View of the rear of the truck. Reels hold microphone, loudspeaker, and the power line cables for easy accessibility.





International SHORT-WAVE

Compiled by **KENNETH R. BOORD**

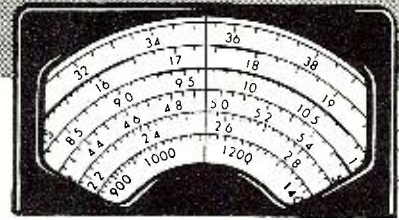

THIS month we are pleased to present some interesting data on reception from Europe as passed along by Edward E. Goodman, Fredericksburg, Virginia. Over the past ten years, Mr. Goodman has kept an informal record of reception from Europe, from which he has compiled this data showing what wave bands are best in his area at different seasons of the year and at various times during the day. His listening post is 50 miles south of Washington, D. C., 50 miles north of Richmond, Virginia, and is located on the Rappahannock River.

The data—by bands—follows:

Summer (May, June, July)—11-m., 0500, 1430; 13-m., 0400, 1600; 16-m., 0230, 1730; 19-m., 0100, 0530, 1430, 1900; 25-m., 2330, 0400, 1600, 2030; 31-m., 1730, 0230; 41-m., 1900, 0100; 49-m., 2030, 2330.

Autumn (August, September, October) and **Spring** (February, March, April)—11-m., 0700, 1300; 13-m., 0530, 1430; 16-m., 0400, 1600; 19-m., 0230, 0700, 1300, 1730; 25-m., 0100, 0530, 1430, 1900; 31-m., 2330, 0400, 1600, 2030; 41-m., 1730, 0230; 49-m., 1900, 0100; 60-m., 2030, 2330.

Winter (November, December, January)—11-m., 0830, 1130; 13-m., 0700, 1300; 16-m., 0530, 1430; 19-m., 0400, 0830, 1130, 1600; 25-m., 0230, 0700, 1300, 1730; 31-m., 0100, 0530, 1430, 1900; 41-m., 1600, 0400; 49-m., 1730, 0230; 60-m., 1900, 0100.

* * *

Club Notes

England—A new club with radio departments is *The International Friendship League*, 5, Aldred Street, Work-sop, Notts., England, founded by Eric Good and Miss Maureen Martin; welcomes overseas members; has monthly bulletin.

USA—New QRA for the *Universal Radio DX Club* is 29201 Dixon Street, Hayward, California. This club should have a new s.w. log out this month or next; is for members only. (Winch, Calif.)

* * *

This Month's Schedules

(NOTE: By the time you read this, some stations will have reverted from

(Note: Unless otherwise indicated, all time is expressed in American EST; add 5 hours for G.C.T. "News" refers to newscasts in the English language. In order to avoid confusion, the 24 hour clock has been used in designating the times of broadcasts. The hours from midnight until noon are shown as 0000 to 1200 while from 1 p.m. to midnight are shown as 1300 to 2400.) The symbol "V" following a listed frequency indicates "varying." The station may operate either above or below the frequency given.

Summer Time to Standard Time; in such cases, you may find schedules one hour later than listed herein.—KRB)

Anglo-Egyptian Sudan—Radio Omdurman, 9.745, is again being heard at good strength daily 2315-2345. (Fargo, Ga., Bellington, N. Y.)

Argentina—LRS2, 11.971, Buenos Aires, noted underneath Radio Brazzaville with weak signal 1949. (Cox, Delaware)

Australia—At the time this was compiled, Radio Australia had just replaced VLC7, 11.81, with VLC4, 15.32, for the morning program to North America 0700-1015; however, reception over the 15.32 outlet was so poor that it is likely a further change will have been effected by this time—probably back to 11.81 and possibly with the old 9.54 channel added. Sydney, 6.090, is coming through well here in West Virginia 0600 with ABC news.

Austria—The Blue Danube Network, 9.617, Salzburg, is scheduled 0000-1800 (Sundays from 0100). (ISWC, London) In verifying for Bellington, N. Y., listed news times as 0030, 0115, 0400, 0600 (followed at 0610 by local news), 0800, 1000, 1215, 1655, 1755. Station officials inform me "we verify here by QSL one hundred per-cent and do appreciate the receipt of an IRC with the reception report." QRA is Station Manager, BDN Salzburg, APO 541, c/o P.M., New York, New York, USA. All transmissions are in English.

Bechuanaland—Mafeking, 8.242, is scheduled 0600-0700, 1200-1430. (Radio Sweden)

Belgian Congo—OTC, 9.767, 50 kw., Leopoldville, has effected new schedules and by this time may be using 9.800 instead of 9.787 in the Second

Transmission, due to QRM on the 9.767 channel during transmissions to the Americas. Schedules are—*First Transmission* — 1100-1245, French, Dutch, program for Belgian missionaries and Belgian seamen and Belgium calling her countrymen in the world; 1245-1300, closedown for change of beams; 1300-1400, Dutch, Belgium calling the Netherlands and South Africa; 1400-1500, English, Belgium calling Great Britain and the British Territories in Africa; 1500-1615, French, Belgium calling France, Switzerland, and the French Union; 1615-1815, Dutch and French, program for Belgian seamen and their French and Dutch friends; 1815-1830, closedown for change of beams.

Second Transmission — 1830-2000, new Portuguese and Spanish period, Belgium calling South America; 2000-2030, Dutch and French, Belgium calling her countrymen in the world; 2030-0015, French and English, Belgium calling Canada and the United States; 0015-0100, French and Dutch, Belgium calling Belgian missionaries in the world; 0100, closedown. Each Monday at 1315-1815 and each Sunday 2030-0015 there is a non-stop musical program (listeners' requests on Monday from 1400); each Wednesday, the English programs are devoted to DX-ers and radio amateurs, giving s.w. data and radio club information; every alternating Friday at 1410 there is a special "Amongst Friends" Edition in Swedish in answer to letters from Swedish listeners; a preview of the coming week's musical programs is radiated each Sunday at 1410 for Britain and is repeated 2210 for North America.

Contrary to reports from outside the (Continued on page 150)

William N. Parker, Raleigh, N. C., likes his new NC-173. He has been a DX-er since '35.



G. Cox, Del., has built up a good log in a hurry, including some fine Far East "catches."



Selecting Your HIGH-FIDELITY SYSTEM



Test console in center permits any of units shown to be "comparison" tested.

By **JAMES F. BECKER**
Consulting Eng., Concord Radio Corp.

A description of the basic units for a home sound installation and what to look for when buying them.

Due to an ever increasing desire for "better listening" on the part of the public, the demand for high-fidelity equipment has shown a very pronounced upswing in recent years. This "sound consciousness" has been an instrumental factor in the development by radio and sound equipment houses of what is now known as the "Hi-Fi Package," a combination of individual units which provides the average music lover with a nearly true reproduction of his or her favorite music, a reproduction heretofore attained only by those few individuals who could spend substantial sums of money for such quality. It is now possible, because of new and improved design on the part of the manufacturers, for a person of moderate means to spend many enjoyable hours listening to high-fidelity reproduction at a reasonable cost.

All of this leads the music listener to ask: What is high-fidelity and how do I go about selecting the units which comprise such a system? How can I choose a "Hi-Fi Package" which will best meet my requirements? What assurance have I that the equipment I choose is the finest available for the amount of money spent? It is the purpose of this article to set forth the major considerations involved in the selection of a "Hi-Fi Package" and

thereby enable you as the average listener to get the most for your money.

"High-Fidelity" Defined

What is high-fidelity? Strangely enough, the sound engineers have not as yet been able to make any clear-cut definition of this term. However, it is generally conceded that there are certain basic characteristics which must be present if true high-fidelity reproduction is to be obtained.

The first of these characteristics is frequency response or the ability of the system to faithfully reproduce all sounds in the musical register from the lowest note on the bass viol to the highest overtone of the piccolo within the audible range. Although this range may vary among individuals, the generally accepted average limits for true reproduction are 30 cycles-per-second for the low frequency end and 15,000 cycles-per-second for the high frequency end.

In addition to wide frequency response, the high-fidelity system (or package) must not only be able to reproduce sounds in the 30 to 15,000 cycle range but reproduce them uniformly. This means that each unit in the system must be capable of reproducing the low tones in the frequency range to the same degree that it is capable of reproducing the high

tones. A system uniformly covering the above range would be considered "flat from 30 to 15,000 cycles."

However, adequate frequency response and uniformity are not enough in themselves. In order for a system to provide true reproduction, it must be free of all extraneous noises that would tend to mar the audible output. This means that it must have a "low distortion" characteristic. In technical terms, an over-all distortion level of three per-cent is considered acceptable.

Taken by and large, a sound reproducing system may be considered to be "high-fidelity" in the layman's language if it imparts life and tonal quality to the sounds being reproduced. Compared to a true high-fidelity system, the ordinary radio console or phonograph reproduction will seem lifeless and without color. The effect of the high-fidelity system is to "remove" the listener from his surroundings and transport him to the performance hall. The listener, upon hearing such a system for the first time, will be quite astounded by the amazing increase in clarity and the addition of sounds (previously inaudible) which will become apparent.

High-Fidelity Components

What are the units which comprise a Hi-Fi system and what are the basic considerations in the selection of each of these? Generally speaking, there are five basic components to a high-fidelity system:

- (1). A radio tuner (FM, AM, or both).
- (2). An automatic phonograph turntable.
- (3). An amplifier.
- (4). A speaker.
- (5). A speaker enclosure which houses the speaker and provides it with the proper baffle and air space.

You, as the buyer, will want to know which of these units is the most important. To which should you devote the greatest share of your attention and financial resources? There are almost as many opinions on this matter as there are types of equipment in use. Actually, each component is the most important one. The units are completely integrated and the over-all performance of the system is determined solely by the performance of the "weakest" individual unit. The quality of the system becomes the quality of the poorest component.

The selection of a fine tuner is entirely superfluous if it is not backed up by a fine amplifier and speaker. Similarly, the performance and ability of an amplifier to reproduce frequencies from 30 to 15,000 cycles means absolutely nothing if a speaker which can only reproduce from 100 to 8,000 cycles is attached to the output.

The speaker enclosure itself can impair the excellent reproduction quali-

ties of a first rate speaker if it is not properly designed to mount the unit in use.

The basic principle to keep in mind then is this: If one component is of inferior quality, the operation of the entire system will be reduced to that level. For this reason then, it is wise to determine first of all how much money you have available to spend and secondly, the proportionate amount you can afford to spend on each unit in order to obtain the same required degree of performance from each.

Home Requirements

Before going into the considerations involved in the selection of each unit, a brief review of the over-all home requirements of a high-fidelity system is in order.

A certain amount of thought should be given to the physical size of the room in which the system will operate. Certainly a small room such as a den will not require the power-handling capabilities of an amplifier designed to operate in a large living room; by the same token, the actual space area available for the installation of the system is apt to be considerably reduced in the smaller room. Therefore, before starting out to select your units, it would be a good idea to have some of these physical requirements in mind.

It would be an excellent idea for you as a prospective buyer to carry with you a mind's eye view of the proposed installation, or better yet, a small sketch of your ideas as you start shopping for your high-fidelity components. Not only will this serve as a reminder to you, but it will also materially aid the sales technician with whom you talk, in that he can better determine the type of system which will best suit your needs.

Individual Components

You are now ready to proceed with the main job of selecting your system, component by component. The considerations offered here are not to be thought of as all-inclusive inasmuch as there are many minor items which will depend largely upon the individual's personal likes and dislikes. These are the major considerations which will affect the over-all operation of the system.

Tuner

The tuner section of the high-fidelity system is the unit which makes possible the reproduction of programs from the radio broadcast field. It may be designed to receive the amplitude-modulated portion of the radio spectrum, or the frequency-modulated portion, or both. Generally speaking, the amplitude-modulated or AM tuner receives little consideration in a high-fidelity system due to the fact that the reproduction of audio frequencies on AM is limited, on the average, to approximately 5000 cycles. If you are limited by financial considerations to the use of a frequency-

modulated or FM tuner and are primarily a music listener, the inability of your tuner to handle AM will mean very little since most musical programs are broadcast simultaneously on FM. (The upper limit of reproduction for FM broadcasting is 15,000 cycles or three times that obtainable on AM.)

In general, the average tuner has been designed to operate on both FM and AM. The ease or ability with which a tuner will receive either type of signal from a distance is known as its sensitivity, and its ability to differentiate between stations is known as selectivity. For those individuals located in metropolitan areas, the sensitivity of the tuner is not too important since most FM stations are located well within the "fringe area." However, for those listeners located beyond the 35-mile point ("fringe area"), sensitivity becomes a prime consideration. First then, select a tuner which will provide adequate FM reception in your locality. Secondly, choose a tuner which will provide adequate selectivity. If you are located in a congested area where several stations are operating near the same frequency, be sure your tuner will easily differentiate between these stations.

Because of the high frequencies on which they operate, many FM tuners tend to "drift" from their initial dial settings thus requiring frequent retuning. Therefore, the third consideration becomes that of choosing a stable tuner. A few of the high priced tuners have an automatic frequency control feature which tends to minimize drift. This is of course a desirable feature. However, the average tuner usually becomes stable once normal operating temperature has been reached.

The fourth major requirement is that of frequency response. Here again, the purse becomes a determining factor since the broader the response the higher the cost. A good tuner, however, should have the ability to reproduce uniformly the audible frequency range from 30 to 15,000 cycles. Furthermore, hum and distortion levels should be inaudible, and separate bass and treble controls should be provided on the tuner if they are not incorporated in the amplifier.

The appearance of the unit is also

important, but this is a matter of individual taste since some will like one design while others prefer another. The physical size can become a major consideration when space is at a premium. This is particularly true where the tuner is to be utilized as a replacement for an existing unit already mounted in a special cabinet.

Phonograph

Selection of a phonograph for the high-fidelity system involves many considerations, both electrical and mechanical. Here again, adequate frequency response is a major factor. Most present day recordings have a top frequency range of 10,000 cycles. The advent of improved recording disc materials and methods has further boosted this range so that special high-fidelity records with a frequency response from 30 to 14,000 cycles are now available. If you plan to buy recordings in this bracket, a phonograph with cartridges designed to reproduce these frequencies should become a part of your system.

The type of head in the pickup arm, whether of the crystal or magnetic cartridge variety, also plays an important part in the selection of the proper phonograph for your need. The output from a crystal cartridge is considerably more than that which can be obtained from the magnetic types, but the frequency response, in most cases, is limited. Some crystal cartridges, recently developed, offer smooth, wide-range response for the new high-fidelity recordings.

The advent of long-playing micro-groove records, designed to operate at speeds of 33½ and 45 revolutions-per-minute, has created a demand for three-speed changers and triple-play or interchangeable heads. As a general rule, today's buyer will almost always purchase a three-speed changer. Two-speed and single-speed changers are rapidly becoming obsolete. The main factor to be considered is the purchase of a changer which will provide the desired degree of reproduction at all three speeds and still stay within the range of one's purse.

Needle arrangements are provided with the better pickup cartridges and their affect on the operation of the head is taken into consideration in the

(Continued on page 163)

A section of the sound room at Concord Radio Corporation's Chicago showrooms. Here a prospective buyer may try out a wide variety of high-fidelity audio components.

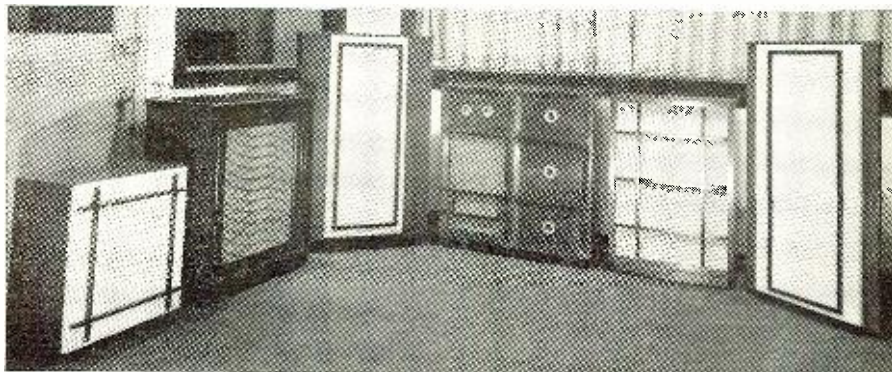

Mac's RADIO SERVICE SHOP

By JOHN T. FRYE



A SOUND SIDELINE

THE crisp, starry November night was filled with the pungent autumn incense of burning leaves as Barney, whistling softly, strode along the empty street on his way home from a picture show. As he passed the radio shop where he worked, the whistle suddenly broke off in the middle of a bar. Something was wrong! He could not see the night light over the service bench that ordinarily was clearly visible through the deliberately left-open door of the service department.

Flattening his freckled nose against the shop window and cupping his hands around his eyes, the youth saw that the service door was closed; furthermore, judging by the ribbon of white light escaping through a crack at the bottom of the door, someone had the main fluorescent lights of the service department turned on.

Wheeling around, Barney shot a quick glance at the cars standing at the curb; then, as he recognized Mac's trim little sedan, the cops-and-robbers melodrama that had already started to flare in his imagination—with you-know-who as the hero—began to fade. Fishing his store key from his pocket, the boy softly opened the door and stepped inside.

Instantly his ears were assailed by a mournful and rather faltering rendition of "Home Sweet Home" being played on a harmonica. He tiptoed across to the service-room door and opened it a crack. A strange sight met his eyes. Mac, his eyes tightly closed, was breathing the melody into a microphone that was set so close in front of him that the backs of his hands, with which he was doing a very professional job of "tremoloing,"

almost brushed it. The floor at his feet was littered with crating boards and packing paper. On the bench in front of him, its plastic reels gleaming as they whirled about, was a brand-new and very resplendent tape recorder.

"Holding out on me, huh" Barney shouted as he banged the door wide open and stepped inside.

Mac's head jerked back beneath his shoulders like a turtle's, and he nearly swallowed his musical instrument at this rude and unexpected interruption of his recital.

"I might have known!" he complained bitterly as he recognized the intruder. "I was going to surprise you with this in the morning, but keeping a secret from a nosey Irishman like you is harder than keeping the medicinal whiskey hidden from Grandpa."

"Never mind that; why the midnight solo?"

"I was just trying out this new tape job. A French-harp is the only instrument that I know well enough to know how it *should* sound. Listen."

He flipped the rewind switches and, after a few seconds of rapid rewinding, started the tape through again. Out of the speaker came the sound of the harmonica with such startling naturalness, even to the breath sounds, that it was hard to realize it *was* a recording.

"Some gadget, eh?" Mac questioned proudly. "It ought to be; it cost enough. Notice that tape is pulled at a steady fifteen inches per second *all* the time and *every* time. That accounts, in part, for those highs. Get a load of how it catches this cymbal." With this he switched the recorder to

"Record" and whanged an old brass cymbal with a screwdriver handle. When it was played back, the brassy sound echoed through the shop exactly the same as it had done before.

"Yes, but what are you going to do with it?" Barney asked.

"Sell records."

"Ha! It sounded just like you said, 'Sell records.'"

"That's what I *did* say. This tape recorder is going to be used to boost our disc recording business, which has never been too robust. My idea is that I shall take down anything I intend to put on disc on this tape-recorder first. That will give me a chance to get a perfect recording before I start cutting a platter. Any needed editing can be done on the tape. If a mistake bobs up, we can simply erase the tape and start over. That will mean a substantial saving in spoiled blanks, and it will allow the customer to be recorded at his best.

"But even better, it will allow me to do 'free-lance' recording. By that I mean that I can take this tape job to high school entertainments, amateur shows, and so on and take down various events that I think some of the performers may be willing to purchase in disc form. Then I can invite those people down to listen to themselves—a hard invitation to resist—and then if they want a permanent disc recording of their performance we can make it for them. If they don't, all we are out is our time."

"Hey, that sounds all right!" Barney said. "You can take programs off the local radio station, too, especially those street-interview sort of things. Lots of people would like to have a record of their voices on a radio station. Since next year is the Year of the Big Wind, election year, you ought to get lots of business from political candidates. Instead of quoting what his honorable opponent said, the rival candidate can actually play a recording of the quotation, which will be a lot more effective."

"And then," Mac chimed in, "there are many special events, such as weddings and so forth, that people would like to have preserved—at least in part. We can take the whole thing down on tape and then let the customers select the portions they want on disc."

"Sounds to me like Mac's Radio Service Shop is going to put a heavier accent on the sideline."

"On several sidelines," Mac corrected. "I have been thinking that we are kind of in a rut just working on radio and TV about ninety-five percent of the time and are letting a lot of good money-making business slip away from us. This is particularly true in the sound field. From now on we are going out aggressively after the sale, rental, service, and installation of all kinds of sound equipment."

"I thought we were doing reasonably well in the rental and service fields," Barney offered.

(Continued on page 168)

RADIO & TELEVISION NEWS

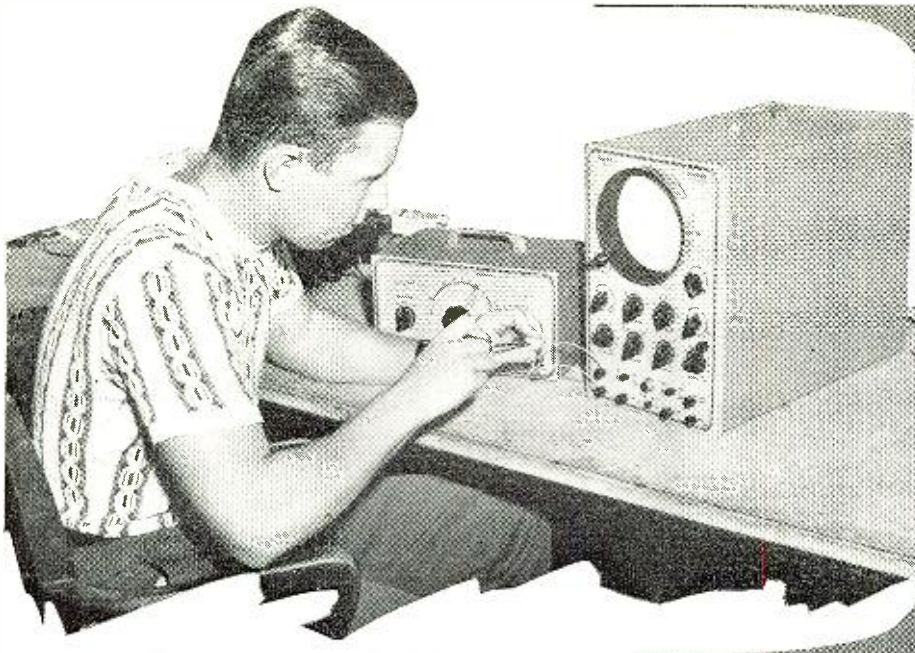

Using compensating circuit to observe square wave patterns.

Let's Put SQUARE WAVES To Work

By
HOWARD ANTHONY
The Heath Company

A discussion of the applications of square wave testing techniques for checking audio amplifiers.

NUMEROUS articles have appeared recently about the theory of square waves but in the busy world of television most of us do not have the time to interpret and apply these theories. Television, however, with its FM sound, makes the applications of square wave testing particularly important. This article deals with a few of the many possible applications.

Once understood, the user will find that square waves simplify and speed audio servicing. One square wave test is the equivalent of ten or more sine wave measurements plotted on a graph. Square wave tests at two points are usually sufficient to establish the response characteristics of the average audio system. One large television manufacturer uses two square wave test frequencies as the only fidelity check on the sound portion of the TV receivers. This saving of testing time is extremely important when thousands of units must be tested. The time in this case is held to a few seconds per unit. The system has been found to be extremely satisfactory. The same technique applied to service work can result in a remarkable saving of service time and better customer satisfaction.

The easiest way to understand the various square wave shapes obtainable is to actually obtain a variety of shapes by use of simple adjustable compensating circuits. By means of these, it is possible to see for yourself the effect of both high and low fre-

quency attenuation or emphasis. Fig. 1 shows such a circuit. The practical start is to build this network and observe its effects. More understanding can be gained this way than in studying hundreds of traces. A square wave may be considered a graph of the performance of the instrument under test at the fundamental and to the thirtieth harmonic of the frequency being used. Thus if the gain of the higher frequencies is more than the fundamental, the square wave will tilt upward while if the higher frequencies are attenuated, the square wave will round off at its forward edge. Using the circuit shown in Fig. 1, it is possible to emphasize or attenuate the higher harmonics and see this effect.

For further understanding and classroom demonstration, a single amplifier stage with variable controls used for each resistive element will show the many possible effects. Where an amplifier is to be used for a special purpose, the use of a square wave of

desired frequency and variable elements will often enable the experimenter to secure several times the normal gain obtained when the standard tube loadings as shown on the tube charts are used.

A suggested procedure for obtaining optimum amplification is as follows. Use a low frequency square wave of 100 cycles. Try several sizes of coupling condensers and establish the minimum size which does not affect the square wave. Replace the cathode resistor with a suitable variable control. A 10,000 ohm control is usually adequate. Replace the plate resistor and screen resistor with variable controls providing ample range of resistance. Initially set each control to the approximate resistance replaced. Adjust each control to obtain the maximum size of square wave without distorting the shape. As there will be interaction between the control settings, the plate and screen controls must be adjusted for each change of the cathode control. After the optimum settings are obtained, the resistance of each control should be noted. This will assure best performance of the amplifier between 100 and 3000 cycles. The entire procedure should then be repeated with the square wave generator set at 1000 cycles giving an indication of the amplifier's performance to well above 20,000 cycles. If there is an appreciable difference between the resistances of the two tests, a compromise can be effected. The variable controls are then replaced by resistors of proper value. The writer has often obtained gains of one and one-half to twice the normal gain of amplifier stages by this method.

In normal service testing of amplifiers, the square wave is fed through the entire instrument. If distortion is found to exist, the oscilloscope connec-

(Continued on page 197)

Fig. 1. Frequency compensating circuit for use in observing square wave shapes.

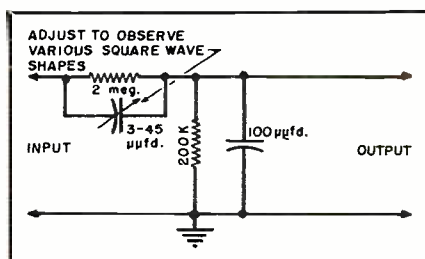

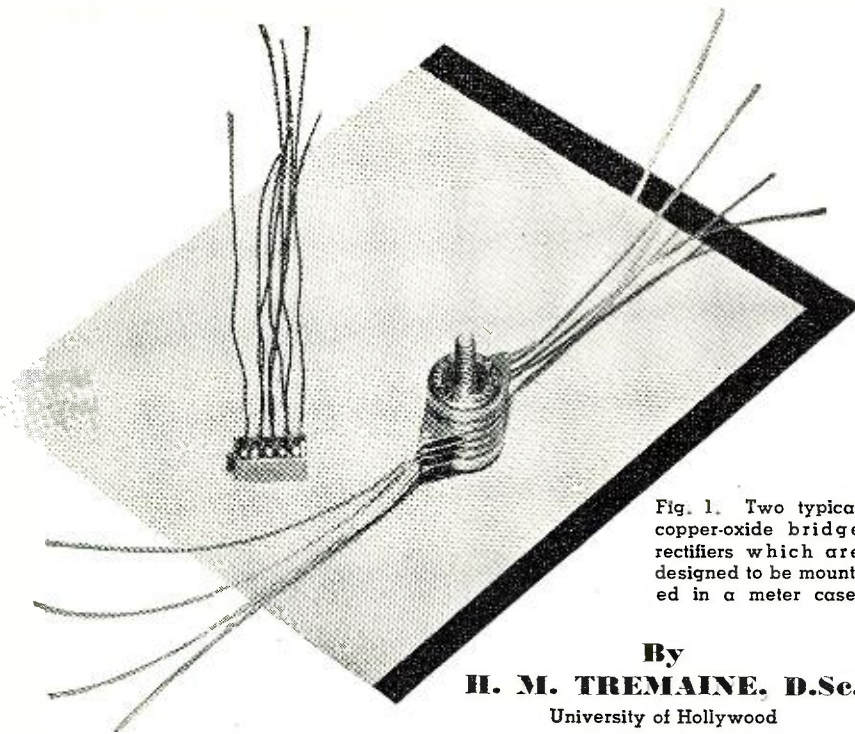

Fig. 1. Two typical copper-oxide bridge rectifiers which are designed to be mounted in a meter case.

By
H. M. TREMAINE, D.Sc.
 University of Hollywood

Power Level and Volume Indicator Meters

A review of the accepted standards used in conjunction with the design and application of db. and vu. meters.

THE measurement of power or program levels in sound circuits is of primary importance to the audio engineer. Meters designed for this purpose are known as "volume indicator (v.i.)" meters and have been in use by the telephone company, radio broadcasting stations, recording companies, and the motion picture industry for many years.

The purpose of these meters, or volume indicators, is to indicate the variation in electrical sound levels. This does not mean that the meter measures the actual volume of sound, but rather the level of voltages generated by the reproducing equipment. Measurement by electrical means is made possible by the fact that the sound intensity is directly proportional to the voltage amplitude in an electrical circuit.

As the voltages generated are of an alternating nature, an a.c. type meter will be required for their measurement. The conventional type a.c. meter used for power measurement is not suitable for this purpose because of its characteristic low impedance and limited response to frequency.

Volume indicator meters are, in reality, sensitive high impedance a.c. voltmeters of wide frequency range,

calibrated either in decibels or volume units relative to one of the two existing reference levels in use by the electronic industry. The device may be either electronic or of the copper-oxide rectifier type.

From a study of the waveforms involved in the transmission of speech and music, at first thought it appears that the measuring instrument should respond to the peak or crest of the wave, rather than the r.m.s. value. Further study, however, indicates that either type meter will be satisfactory. Also, it has been found that phase distortion affects the readings of peak indicating meters, although it may not

Fig. 2. (A) A half-wave rectifier and (B) a full-wave bridge rectifier.

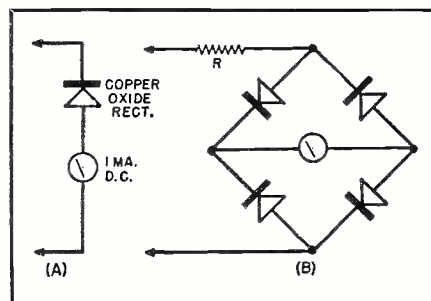

be apparent to the ear, thus possibly causing overloading of the system because of incorrect readings.

Two terms are in general usage in regard to meters used for audio frequency measurements. They are the volume level indicator and the power level indicator. The first term applies only to meters used for monitoring program material of complex waveforms which is varying in both amplitude and frequency. The second term is applied to meters used for the measurement of sound circuits where steady-state conditions are maintained by using sine wave power.

Power Level Indicator

The principal difference between the volume level indicator and the power level meter is in damping. In the volume level indicator definite characteristics have been standardized by the industry and are built into the meter movement to control its sensitivity, damping, frequency range, and input impedance. In the power level meter, only the frequency range and sensitivity are of importance. Volume level meters may be used to measure both steady-state conditions and complex waveforms; however, this does not apply to power level meters.

In the early days of broadcasting and recording, the volume level indicator was of the electronic type, having characteristics which were considered by its designers to be the most suitable. This situation led to considerable confusion throughout the industry as measurements made in one connection could not be correlated with other measurements. In addition, the meter employed one or more vacuum tubes and required both a high and low voltage source for its operation. This feature restricted the use of these meters to the laboratory or studio control room.

Around 1929 the copper-oxide rectifier volume level indicator made its appearance. This meter employed a 1 ma. d.c. D'Arsonval type movement which utilized a half-wave copper-oxide rectifier connected in series with one side of the meter. See Fig. 2A. This resulted in a fairly sensitive meter which was handicapped, however, by a limited frequency response and poor damping. The use of the half-wave rectifier resulted in a non-symmetrical response to complex waveforms. Later the rectifier was changed to a full-wave bridge type, Fig. 2B, which eliminated the distortion introduced by the half-wave rectifier.

Full-wave rectification is essential in meters used for audio frequency measurements since the human voice consistently generates peaks of greater amplitude for one polarity than the other. Under these conditions it would be impracticable to use half-wave rectification unless the circuits were poled and the meter polarity was fixed. Furthermore, if a bi-directional microphone was in use and it was reversed 180 degrees, the peaks, as indicated by the meter, would also be reversed and, depending on the original polarity,

might cause overloading of the electrical circuits due to the incorrect meter readings.

With the adoption of the full-wave rectifier, the meter sensitivity was increased by replacing the 1 ma. movement with one of 500 microampere sensitivity. A resistance was placed in series with the movement to increase the meter impedance to 5000 ohms and at the same time adjust its sensitivity to some definite reference level. When this meter was introduced, the reference level for audio frequency measurements was 6 milliwatts of power in a 500 ohm circuit. For this amount of power, 1.73 volts is developed across the circuit. The meter movement indicated this 1.73 volt reference point on the scale slightly to the left of its center position. See Fig. 3.

Power level meters are used for setting the levels of recording or reproducing systems and are generally connected in the circuit at a point where the signal is distributed to other portions of the system. This point is, as a rule, the bridging bus.

The power level indicator meter is used strictly for steady-state sine wave measurements and is not suitable for monitoring program material as its damping is such that the meter tends to overshoot its mark, thus giving rise to false indications with changing levels.

Three types of meter movements are available for power level indicators: 1. the "high speed" or HS movement used for high speed measurements; 2. the "general purpose" or GP movement work; and 3. the "slow speed" or SS movement which is generally employed in making acoustic measurements. The different types of movements may be identified by the symbols "GP," "SS," or "HS" which appear on the meter face.

To increase the operating range of the meter movement above the reference level, a 5000 ohm "L" type attenuator is placed ahead of the meter. See Fig. 4. The attenuator performs two functions, i.e., it extends the range above the reference level, and permits this extension without affecting the 5000 ohm input impedance. A constant input impedance is essential as it allows the input attenuator setting to be changed during operation without upsetting the impedance of the circuit bridged by the meter.

The "L" type attenuator does not present a constant impedance looking in both directions, but only to the source bridged. The arms R_1 and R_2 are connected mechanically by the common shaft and are varied inversely. Therefore, R_2 may drop to only a few ohms when the attenuator is set to the higher ranges. The loss potentiometer should be thought of as a meter multiplier. For the power level meter, the settings of the attenuator usually start at zero and continue in steps of 1 or 2 db. to at least +30 db. above the reference level. The meter face is calibrated from -10 db. to +6

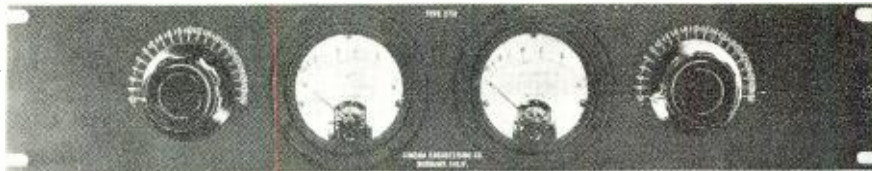

Fig. 3. Panel view of a dual power level indicator, manufactured by Cinema Engineering Co.

db. Adding the meter dial readings and the attenuator settings algebraically results in a range of from -10 db. to a +36 db., or a total spread of 46 db.

Copper-oxide instrument rectifiers are approximately 70% efficient and are excellent for rectification at audio frequencies providing the voltage across any one element in the bridge does not exceed 11 volts and that the temperature does not rise above 160 degrees F. With the attenuator placed ahead of the meter, the voltage across the rectifier elements, under normal operating conditions, does not exceed 4 volts. Two typical bridge type rectifiers, designed to be mounted in the meter movement case, are shown in Fig. 1.

The frequency response of the early instrument rectifiers was deficient at frequencies above 6000 cycles, dropping off as much as 4 db. at 10,000 cycles. At first this was attributed to the capacity between the plates of the rectifying elements, but subsequent investigation proved that this was not entirely the case. While it is true that some effect was contributed by the capacity, the major factor was the rectifying qualities of the elements at the higher frequencies.

Present day instrument rectifiers are highly developed and will respond to several hundred thousand cycles-per-second. The frequency response of a typical copper-oxide rectifier is shown in Fig. 5.

The VU. Meter

Because of the inaccuracies inherent in the copper-oxide rectifier power level meter and because of the fact that it was not satisfactory for program monitoring, the development of an entirely new meter was jointly undertaken by the *Bell Telephone Laboratories*, *Columbia Broadcasting System*, and the *National Broadcasting Company*. The result of this research was the development not only of a new type volume indicator meter but also a new reference level of 1 milliwatt, a

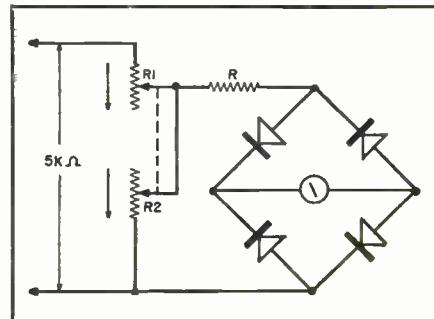

Fig. 4. Circuit diagram of a rectifier-type meter with an "L" type variable attenuator.

unit which was adopted by the electronic industry in May 1939.

This new meter, shown in Fig. 6, is termed a "volume unit (vu.)" meter. This instrument is calibrated in volume units numerically equal to the number of decibels above the reference level of 1 milliwatt of power in a 600 ohm circuit. With this new meter came a new term, "zero dbm.," meaning that the level under discussion is in relation to 1 milliwatt of power in a 600 ohm circuit. In discussing reference levels, the term "dbm." applies only to the 1 milliwatt reference level, while "db." is used to express levels referring to the 6 milliwatt reference level.

The 1 milliwatt reference level has three distinct advantages. It is a unit quantity, hence it is readily applicable to the decimal system, being related to the watt by the factor 10^{-3} which results in positive values for the majority of measurements. A further advantage of the vu. meter is that all meters of this type are exactly alike in construction and characteristics and, when several are connected across the same circuit, may be tested by the application of a 1000 cycle signal for checking their operation.

VU. Meter Characteristics

The characteristics for the vu. meter were adopted after careful consideration as being most suitable for all applications.

Fig. 5. The frequency response of a conventional copper-oxide instrument rectifier.

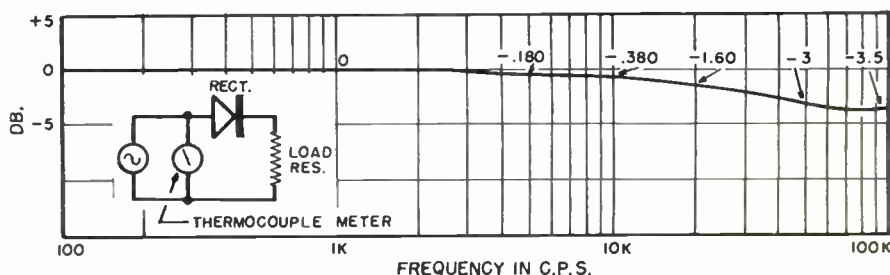

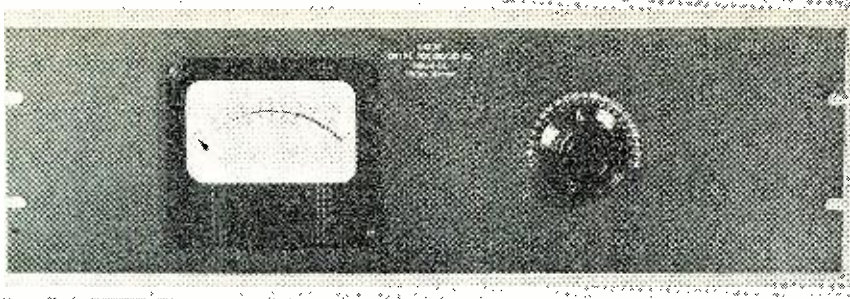

Fig. 6. Panel view of Cinema Engineering Co.'s volume unit (or vu.) meter.

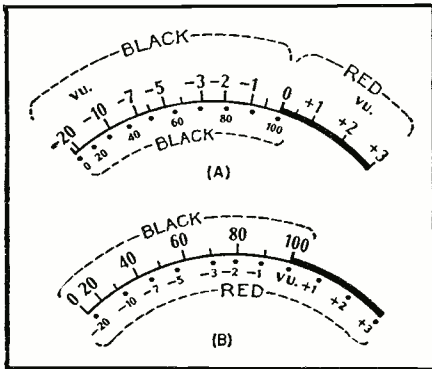

Fig. 7. Two of the scale cards used on vu. meters. (A) Card calibrated in percentages of modulation for b.c. and recording applications. (B) calibrated in db. for general test work and laboratory applications.

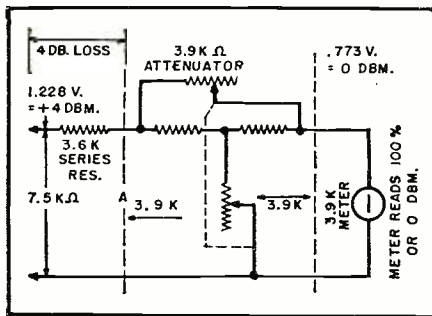
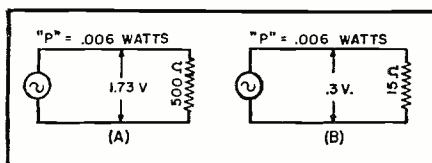

Fig. 8. Circuit diagram of the vu. meter.

1. *General.* The volume indicator employs a d.c. meter movement with a non-corrosive, full-wave, copper-oxide rectifier unit, and responds approximately to the r.m.s. value of the impressed voltage. This will vary somewhat depending on the waveforms and the per-cent harmonics present in the signal.

2. *Scale of instrument.* The face of the instrument may have either of the two scale cards shown in Fig. 7. Each card has two scales, one a vu. scale ranging from -20 to +3 vu., and the other a per-cent voltage scale ranging from 0 to 100 with the 100 point coinciding with the 0 point on the vu. scale. The normal point for reading

Fig. 9. Comparison of voltages in a 500 ohm and 15 ohm circuit for same power.



volume levels is at the 0 vu. or 100 scale point which is located to the right of the center at about 71% of the full-scale arc.

3. *Dynamic characteristics.* With the instrument connected across a 600 ohm external resistance, the sudden application of a sine wave voltage sufficient to give a steady-state deflection at the 0 vu. or 100 scale point, should cause the pointer to overshoot not less than 1% nor more than 1.5% (.15 db.). It should be capable of reaching 99 on the per-cent voltage scale in .3 second.

4. *Response vs. frequency.* The instrument sensitivity should not depart from that at 1000 c.p.s. by more than .2 db. between 35 and 10,000 c.p.s. nor more than .5 db. between 25 and 16,000 c.p.s.

5. *Sensitivity.* The application of a sinusoidal potential of 1.228 volts (4 db. above 1 milliwatt in 600 ohms) to the instrument, in series with the proper external resistance (3600 ohms), will cause a deflection to the 0 vu. or 100% point.

6. *Impedance.* For bridging across a line the volume indicator, including the instrument and proper series resistance (3600 ohms), should have an impedance of 7500 ohms when measured with a sinusoidal voltage sufficient to deflect the meter to the 0 vu. or 100% scale point.

7. *Harmonic distortion.* The harmonic distortion introduced in a 600 ohm circuit when a volume indicator is bridged across it is less than .3% under the worst possible condition (when there is no loss in the variable attenuator).

8. *Overload.* The instrument must be capable of withstanding, without injury or effect on the calibration, peaks of *ten times* the voltage equivalent to a reading of 0 vu. or 100% for .5 second, and a continuous overload of *five times* that voltage.

The selection of the scale for the meter face will depend on its application. For broadcasting and recording purposes where it is desirable to know the percentages of modulation the scale of Fig. 7B is used. For laboratory and general test work the scale of Fig. 7A is employed because most of the readings will be in vu.

The circuit diagram of the complete vu. meter is shown in Fig. 8. The meter movement consists of a 50 microampere d.c. D'Arsonval movement and a full-wave bridge rectifier. The meter impedance, including the rectifier, is 3900 ohms.

A 3900 ohm variable attenuator and a 3600 ohm series resistor are connected ahead of the meter. As a rule, devices which are to be bridged across circuits of 600 ohms should have at least ten times the impedance of the circuit being bridged. Connecting the 3600 ohm resistor ahead of the attenuator provides a bridging impedance of 7500 ohms.

Attenuators designed for use with vu. meters are constructed with the attenuator dial calibrations starting at +4 dbm. and continuing in steps of 2 db. up to +44 dbm. No. 0 dbm. position is provided. The reason for this is that by placing a 3600 ohm resistor ahead of the attenuator to raise the input impedance, a loss of 4 db. is incurred.

If the 3900 ohm meter movement and the attenuator (the attenuator in its +4 dbm. position has zero loss) is placed across a 600 ohm circuit in which 1 milliwatt of power is flowing, the pointer will be deflected to the 100% or 0 dbm. mark. When the 3600 ohm series resistor is inserted in the circuit the sensitivity of the meter is lowered by 4 db. To bring the deflection back to the 100% mark will now require +4 dbm. at the input.

It is the practice of the telephone company to allow signal levels from +4 dbm. to +8 dbm. to be transmitted over the average cable pair. Thus, with the meter connected as shown in Fig. 8, the 100% mark will indicate a +4 dbm. signal level.

The advantage to be obtained by the use of the vu. meter over the power level and older type v.i. meters are: a 7500 ohm bridging impedance; the 100% or 0 dbm. mark may be set to represent a maximum signal level permitted by the telephone company and if associated with a line feeding a radio transmitter or recording system, it will indicate the percentage of modulation; uniform damping; and frequency response which allows the correlation of measurements with other activities.

An important point to remember in using the attenuator is that the zero calibration point on the meter always becomes that of the attenuator setting and the meter indications are in reference to that setting. The greatest accuracy for either the power level or volume indicator meter lies between the -1 db. and the +1 db. calibration points on the meter scale. Thus, all readings should be made between these points, if possible, by adjusting the input attenuator and then adding the readings algebraically.

Power Level Meters

Power level meters are generally calibrated in reference to 6 milliwatts of power in a 500 ohm circuit and if placed across an impedance other than 500 ohms will not read correctly. To obtain the correct reading a "correction factor" is applied to the indicated reading to obtain the true power in the circuit. Fig. 9 demonstrates why the meter does not read correctly.

(Continued on page 94)

**You GET
THE BEST IN
Heathkits**

Heathkits are the Quality Line of TEST INSTRUMENT KITS

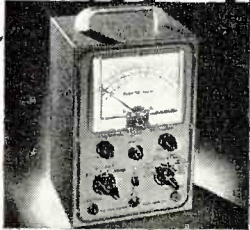

Modern STYLING KITS THAT MATCH

Heathkits are styled in the most modern manner by leading industrial stylists. They add beauty and utility to any laboratory or service bench. There is a complete line of Heathkit instruments allowing a uniformity of appearance.

An attractive service shop builds a feeling of confidence. Many organizations have standardized on Heathkits providing uniform service departments.

There is no waste space or false effort to appear large in Heathkits — space on service benches is limited and the size of Heathkit instruments is kept as small as is consistent with good engineering practice.

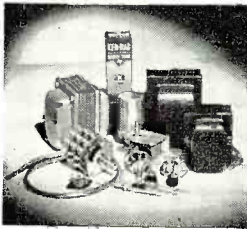

Accuracy ASSURED BY PRECISION PARTS

Wherever required, the finest quality 1% ceramic resistors are supplied. These require no aging and do not shift. No matching of common resistors is required. You find in Heathkit the same quality voltage divider resistors as in the most expensive equipment.

The transformers are designed especially for the Heathkit unit. The scope transformer has two electrostatic shields to prevent interaction of AC fields.

These transformers are built by several of the finest transformer companies in the United States.

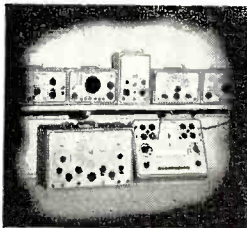

Manufacturers assemble Heathkits in quantity for their own use thus keeping purchase cost down.

Used BY LEADING MANUFACTURERS

Leading TV and radio manufacturers use hundreds of Heathkits on the assembly lines. Heathkit scopes are used in the alignment of TV tuners. Impedance bridges are serving every day in the manufacture of transformers. Heathkit VTVM's are built into the production lines and test benches. Many manufacturers purchase Heathkits in quantity for their own use thus keeping

Famous HEATHKIT PARTS

- MALLORY FILTER CONDENSERS
- WILKOR PRECISION RESISTORS
- GRIGSBY ALLISON SWITCHES
- ALLEN-BRADLEY RESISTORS
- GENERAL ELECTRIC TUBES
- CHICAGO TRANSFORMER
- CENTRALAB CONTROLS
- SIMPSON METERS
- CINCH SOCKETS

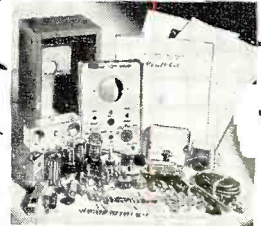

Complete KITS WITH PARTS THAT FIT...

When you receive your Heathkit, you are assured of every necessary part for the proper operation of the instrument.

Beautiful cabinets, handles, two-color panels, all tubes, test leads where they are a necessary part of the instrument, quality rubber line cords and plugs, rubber feet for each instrument, all scales and dials ready printed and calibrated. Every Heathkit is 110 V 60 Cy. power transformer operated by a husky transformer especially designed for the job. Heathkit chassis are precision punched for ease of assembly. Special engineering for simplicity of assembly is carefully considered.

Complete INSTRUCTION MANUALS

Heathkit instruction manuals contain complete assembly data arranged in a step-by-step manner. There are pictorials of each phase of the assembly drawn by competent artists with detail allowing the actual identification of parts. Where necessary, a separate section is devoted to the use of the instrument. Actual photos are included to aid in the proper location of wiring.

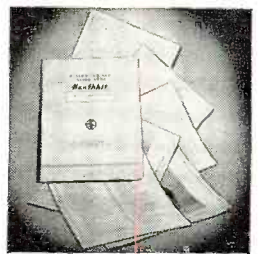

Used BY LEADING UNIVERSITIES

Heathkits are found in every leading university from Massachusetts to California. Students learn much more when they actually assemble the instrument they use. Technical schools often include Heathkits in their course and these become the property of the students. High schools, too, find that the purchase of inexpensive Heathkits allows their budget to go much further and provides much more complete laboratories.

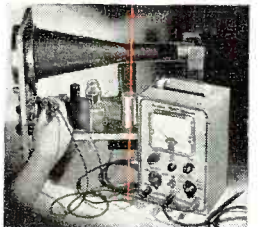

YOU SAVE BY ORDERING DIRECT FROM MANUFACTURER — USE ORDER BLANK ON LAST PAGE

IMPORT AGENT
ROCKE INTERNATIONAL CORP.
135 E. 40th ST.
NEW YORK CITY (16)
CABLE: ARLAB-NY

The HEATH COMPANY

... BENTON HARBOR 15, MICHIGAN

12 Improvements IN NEW 1951

MODEL O-6

PUSH-PULL

Heathkit OSCILLOSCOPE KIT

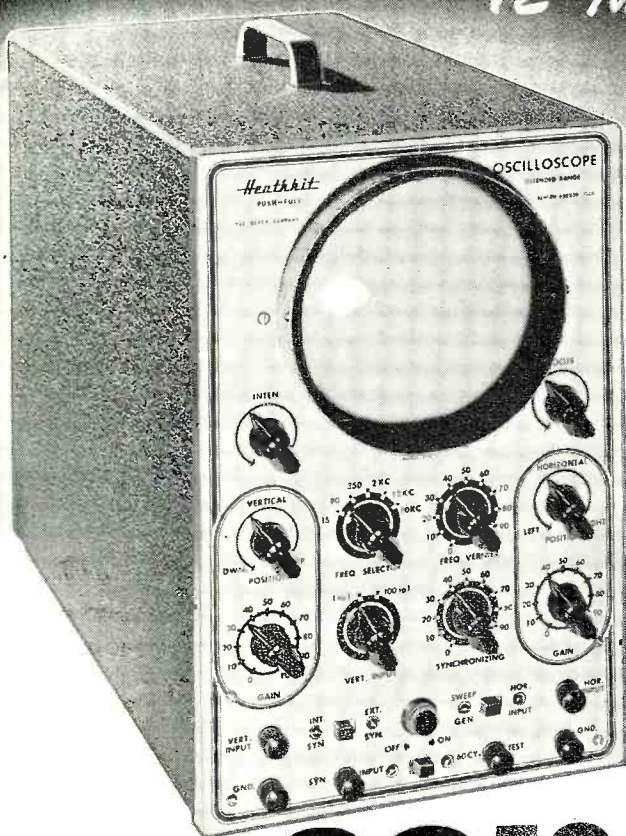

Only **\$39.50**

New INEXPENSIVE MODEL S-2 ELECTRONIC SWITCH KIT

Twice as much fun with your oscilloscope — observe two traces at once — see both the input and output traces of an amplifier, and amazingly you can control the size and position of each trace separately — superimpose them for comparison or separate for observation — no connections inside scope. All operation electronic, nothing mechanical — ideal for classroom demonstrations — checking for intermittents, etc. Distortion, phase shift and other defects show up instantly. Can be used with any type or make of oscilloscope. So inexpensive you can't afford to be without one.

Has individual gain controls, positioning control and coarse and fine switching rate controls — can also be used as square wave generator over limited range. 110 Volt transformer operated comes complete with tubes, cabinet and all parts. Occupies very little space beside the scope. Better get one. You'll enjoy it immensely. Model S-2. Shipping Wt., 11 lbs.

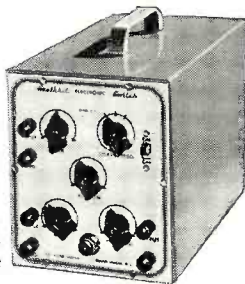

Only **\$19.50**

- ★ New AC and DC push-pull amplifier.
- ★ New step attenuator frequency compensated input.
- ★ New non frequency discriminating input control.
- ★ New heavy duty power transformer has 68% less magnetic field.
- ★ New filter condenser has separate vertical and horizontal sections.
- ★ New intensity circuit gives greater brilliance.
- ★ Improved amplifiers for better response useful to 2 megacycles.
- ★ High gain amplifiers .04 Volts RMS per inch deflection.
- ★ Improved Allegheny Ludlum magnetic metal CR tube shield.
- ★ New synchronization circuit works with either positive or negative peaks of signal.
- ★ New extended range sweep circuit 15 cycles to over 100,000 cycles.
- ★ Both vertical and horizontal amplifier use push-pull pentodes for maximum gain.

The new 1951 Heathkit Push-Pull Oscilloscope Kit is again the best buy. No other kit offers half the features — check them. Measure either AC or DC on this new scope — the first oscilloscope under \$100.00 with a DC amplifier.

The vertical amplifier has frequency compensated step attenuator input into a cathode follower stage. The gain control is of the non frequency discriminating type — accurate response at any setting. A push-pull pentode stage feeds the C.R. tube. New type positioning control has wide range for observing any portion of the trace.

The horizontal amplifiers are direct coupled to the C.R. tube and may be used as either AC or DC amplifiers. Separate binding posts are provided for AC or DC.

The multivibrator type sweep generator has new frequency compensation for the high range it covers; 15 cycles to cover 100,000 cycles. The new model O-6 Scope uses 10 tubes in all — several more than any other. Only Heathkit Scopes have all the features.

New husky heavy duty power transformer has 50% more laminations. It runs cool and has the lowest possible magnetic field. A complete electrostatic shield covers primary and other necessary windings and has lead brought out for proper grounding.

The new filter condenser has separate filters for the vertical and horizontal screen grids and prevents interaction between them. An improved intensity circuit provides almost double previous brilliance and better intensity modulation.

A new synchronization circuit allows the trace to be synchronized with either the positive or negative pulse, an important feature in observing the complex pulses encountered in television servicing.

The magnetic alloy shield supplied for the C.R. tube is of new design and uses a special metal developed by Allegheny Ludlum for such applications.

The Heathkit scope cabinet is of aluminum alloy for lightness of portability.

The kit is complete, all tubes, cabinet, transformer, controls, grid screen, tube shield, etc. The instruction manual has complete step-by-step assembly and pictorials of every section. Compare it with all others and you will buy a Heathkit. Model O-6. Shipping Wt., 30 lbs.

YOU SAVE BY ORDERING DIRECT FROM MANUFACTURER — USE ORDER BLANK ON LAST PAGE

EXPORT AGENT
ROCKE INTERNATIONAL CORP.
13 E. 40th ST.
NEW YORK CITY (10)
CABLE: ARLAB-N.Y.

The **HEATH COMPANY**

... BENTON HARBOR 15, MICHIGAN

New 1951 • • MODEL V-4A

Heathkit VTVM KIT

HAS EVERY EXPENSIVE Feature

- ★ Higher AC input impedance, (greater than 1 megohm at 1000 cycles).
- ★ New AC voltmeter flat within 1 db 20 cycles to 2 megacycles (600 ohm source).
- ★ New accessory probe (extra) extends DC range to 30,000 Volts.
- ★ New high quality Simpson 200 microampere meter.
- ★ New 1/2% voltage divider resistors (finest available).
- ★ 24 Complete ranges.
- ★ Low voltage range 3 Volts full scale (1/3 of scale per volt).
- ★ Crystal probe (extra) extends RF range to 250 megacycles.
- ★ Modern push-pull electronic voltmeter on both AC and DC.
- ★ Completely transformer operated isolated from line for safety.
- ★ Largest scale available on streamline 4 1/2 inch meter.
- ★ Burn-out proof meter circuit.
- ★ Isolated probe for dynamic testing no circuit loading.
- ★ New simplified switches for easy assembly.

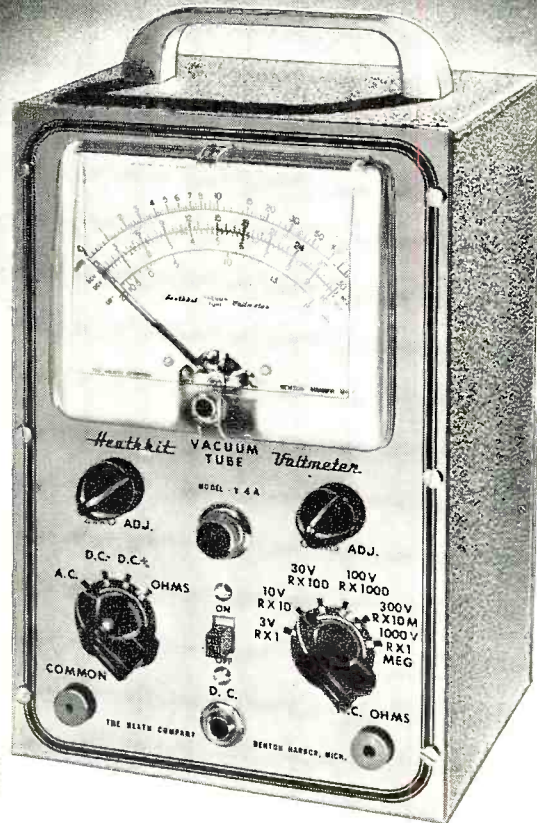

New
LOW PRICE **\$23.50**

The new Heathkit Model V-4A VTVM Kit measures to 30,000 Volts DC and 250 megacycles with accessory probes — think of it, all in one electronic instrument more useful than ever before. The AC voltmeter is so flat and extended in its response it eliminates the need for separate expensive AC VTVM's. + or - db from 20 cycles to 2 megacycles. Meter has decibel ranges for direct reading. New zero center on meter scale for quick FM alignment.

There are six complete ranges for each function. Four functions give total of 24 ranges. The 3 Volt range allows 33 1/3% of the scale for reading one volt as against only 20% of the scale on 5 Volt types.

The ranges decade for quick reading.

New 1/2% ceramic precision are the most accurate commercial resistors available — you find the same make and quality in the finest laboratory equipment selling for thousands of dollars. The entire voltage divider decade uses these 1/2% resistors.

New 200 microampere 4 1/2" streamline meter with Simpson quality movement. Five times as sensitive as commonly used 1 MA meters.

Shatterproof plastic meter face for maximum protection. Both AC and DC voltmeter use push-pull electronic voltmeter circuit with burn-out proof meter circuit.

Electronic ohmmeter circuit measures resistance over the amazing range of 1/10 ohm to one billion ohms all with internal 3 Volt battery. Ohmmeter batteries mount on the chassis in snap-in mounting for easy replacement.

Voltage ranges are full scale 3 Volts, 10 Volts, 30 Volts, 100 Volts, 300 Volts, 1000 Volts. Complete decading coverage without gaps.

The DC probe is isolated for dynamic measurements. Negligible circuit loading. Gets the accurate reading without disturbing the operation of the instrument under test. Kit comes complete, cabinet, transformer, Simpson meter, test leads, complete assembly and instruction manual. Compare it with all others and you will buy a Heathkit. Model V-4A. Shipping Wt., 8 lbs. Note new low price, \$23.50



New 30,000 VOLT DC PROBE KIT

Beautiful new red and black plastic high voltage probe. Increases input resistance to 1100 megohms, reads 30,000 Volts on 300 Volt range. High input impedance for minimum loading of weak television voltages. Has large plastic insulator rings between handle and point for maximum safety. Comes complete with PL55 type plug.

No. 3366 High Voltage Probe Kit.
Shipping Wt., 2 pounds. **\$550**

Heathkit RF PROBE KIT

Crystal diode probe kit extends range to 250 megacycles = 10% comes complete with all parts, crystal, cable and PL55 type plug.

No. 309 RF Probe Kit.
Shipping Wt., 1 lb. **\$550**



YOU SAVE BY ORDERING DIRECT FROM MANUFACTURER — USE ORDER BLANK ON LAST PAGE

EXPORT AGENT
ROCKE INTERNATIONAL CORP.
131 E. 40th ST.
NEW YORK CITY (16)
CABLE: ARAB-N.Y.

The HEATH COMPANY

... BENTON HARBOR 15, MICHIGAN

NEW Heathkit T.V. ALIGNMENT GENERATOR KIT

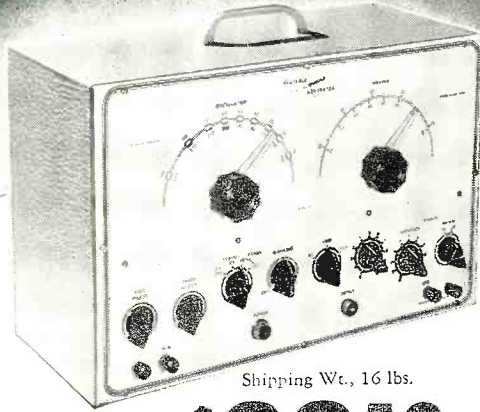

Shipping Wt., 16 lbs.

\$39.50

- ★ New simplified circuit for easy calibration and assembly.
- ★ New 2 band built-in marker covers 19 to 75 Mc.
- ★ New dual spider sweep motor for long life.
- ★ New blanking circuit gives base line for better alignment.
- ★ New variable oscillator gives high output fundamentals on high TV band.
- ★ New standby switch keeps instrument ready for instant use.
- ★ New 6 to 1 slow speed drive on both master oscillator and marker tuners.

The new Heathkit TV Alignment Generator incorporates the new developments required for modern TV servicing. An absorption marker circuit covering all possible 1F bands and even several of the RF bands. The new blanking circuit provides a base reference line which is invaluable in establishing proper traces. The new sweep motor incorporates dual spiders in the speaker frame assuring better alignment and long life. The mounting of the speaker sweep motor has been simplified for easy alignment.

The variable master oscillator covers 140 to 230 Mc. thus giving high output fundamentals where they are most needed. Low band coverage 2 Mc. to 90 Mc.

A new step attenuator provides excellent control of output.

Planetary 6 to 1 drives on both oscillator and marker provides smooth easy control settings.

A standby position is provided making the instrument always instantly available.

Horizontal sweep voltage with phasing control is provided. No other sweep generator under \$100.00 provides all these features — comes complete with instruction manual. Model TS-2.

Heathkit CONDENSER CHECKER KIT

Only **\$19.50**

Features

- Power factor scale.
- Measures resistance.
- Measures leakage.
- Checks paper-mica electrolytics.
- Bridge type circuit.
- Magic eye indicator.
- 110 V. transformer operated.
- All scales on panel.

Checks all types of condensers over a range of .00001 MFD to 1,000 MFD. All on readable scales that are read direct from the panel. NO CHARTS OR MULTIPLIERS NECESSARY. A condenser checker anyone can read. A leakage test and polarizing voltage for 20 to 500 Volts provided. Measures power factor of electrolytics between 0% and 50%. 110 V. 60 cycle transformer operated complete with rectifier and magic eye tube, cabinet, calibrated panel, test leads and all other parts. Clear detailed instructions for assembly and use. Model C-2. Shipping Wt., 7 lbs.

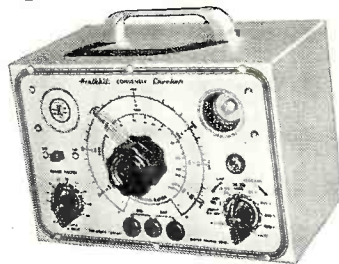

NEW Heathkit SIGNAL TRACER AND UNIVERSAL TEST SPEAKER KIT

\$19.50

Features

- High sensitivity
- Complete set of speaker impedances
- Tests microphones and PA systems
- Tests both single and push-pull speaker circuits

The popular Heathkit Signal Tracer has now been combined with a universal test speaker at no increase in price. The same high quality tracer follows signal from antenna to speaker — locates intermittents — defective parts quicker — saves valuable service time — gives greater income per service hour. Works equally well on broadcast — FM or TV receivers. The test speaker has assortment of switching ranges to match push-pull or single output impedance. Also test microphones, power transformer — comes complete — cabinet, 110 V. 60 cycle power transformer — tubes, test probe, all parts and detailed instructions for assembly and use. Model T-2. Shipping Wt., 8 lbs.

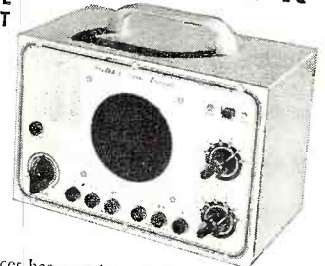

Heathkit TUBE CHECKER KIT

Features

Sockets for every modern tube — blank for new types.

Fastest method of testing tubes — saves time — makes more profit.

Rugged counter type birch cabinet.

Test your tubes the modern way — dynamically — the simplest, yet fastest and surest method — your Heathkit has a switch for each tube element and measures that element — no chance for open or shorted elements slipping by, all the advantages of the mutual conductance type without the slow cumbersome time consuming setups.

Your Heathkit Tube Checker has all the features — beautiful 3 color BAD-GOOD meter — complete selection of voltages — roller chart listing hundreds of tubes including the new 9 pin miniatures — finest quality Centralab lever switches for each element — high grade birch counter type cabinet — continuously variable line adjust control — every feature you need to sell tubes properly. The most modern type tube checker with complete protection against obsolescence. The best of parts — rugged oversize 110 V. 60 cycle power transformer — finest of Mallory and Centralab switches and controls, complete set of sockets for all type tubes with blank spare for future types. Fast action brass gear driven roller chart quickly locates the settings for any type tube. Simplified switching cuts necessary testing time to minimum and saves valuable service time. Short and open element check. Simple method allows instant setup of new tube types without waiting for factory data. No matter what the arrangements of tube elements, the Heathkit flexible switching arrangement easily handles it. Order your Heathkit Tube Checker Kit today. See for yourself that Heath again saves you two-thirds and yet retains all the quality — this tube checker will pay for itself in a few weeks — better assemble it now. Complete with instructions — pictorial diagrams — all parts — cabinet — ready to wire up and operate. Model TC-1 Shipping Wt., 12 lbs.

Gear driven roller chart gives instant setup for all types.

Tests each element separately for open or short and quality.

Beautiful 3 color meter — reads good-bad and line set point.

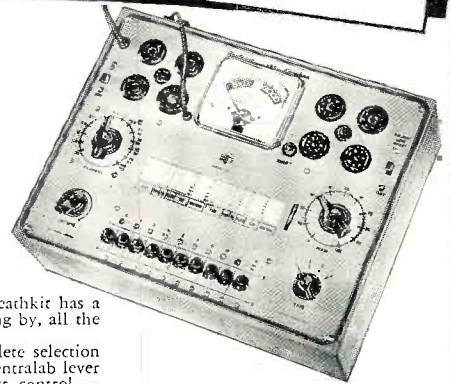

\$29.50

YOU SAVE BY ORDERING DIRECT FROM MANUFACTURER — USE ORDER BLANK ON LAST PAGE

REPORT AGENT
ROCKE INTERNATIONAL CORP.
13 E. 40th ST.
NEW YORK CITY (16)
CABLE: RELAB-N.Y.

The HEATH COMPANY

... BENTON HARBOR 15, MICHIGAN

NEW 1951
Heathkit

SIGNAL GENERATOR KIT

Features

- Sine wave audio modulation.
- Extended range 160 Kc. to 50 megacycles fundamentals.
- New step attenuator output.
- New miniature HF tubes.
- Transformer operated for safety.
- Calibrated harmonics to 150 megacycles.
- New external modulation switch.
- 5 to 1 vernier tuning for accurate settings.

A completely new Heathkit Signal Generator Kit. Dozens of improvements. The range on fundamentals has been extended to over 50 megacycles; makes this Heathkit ideal as a marker oscillator for T.V. New step attenuator gives controlled outputs from very low values to high output. A continuously variable control is used with each step. New miniature HF tubes are required for the high frequencies covered.

Uses 6C4 master oscillator and 6C4 sine wave audio oscillator. The set is transformer operated and a husky selenium rectifier is used in the power supply. The coils are precision wound and checked for calibration making only one adjustment necessary for all bands.

New sine wave audio oscillator provides internal modulation and is also available for external audio testing. Switch provided allows the oscillator to be modulated by an external audio oscillator for fidelity testing of receivers.

A best buy — think of all the features for less than \$20.00. The entire coil and tuning assembly are assembled on a separate turret for quick assembly — comes complete — all tubes — cabinet — test leads — every part. The instruction manual has step-by-step instructions and pictorials. It's easy and fun to build a Heathkit Model SG-6 Signal Generator. Shipping Wt., 7 lbs.



\$19.50

Heathkit SINE AND SQUARE WAVE AUDIO GENERATOR KIT

Either sine or square wave.
Stable RC bridge circuit.
Covers 20 to 20,000 cycles.
Less than 1% distortion.

Hundreds of Heathkit Audio Generators are used by speaker manufacturers—definite proof of their quality and dependability. The added feature of square wave opens up an entirely new field of amplifier testing. Uses the best of parts, 4 gang condenser, 1% calibrating resistors, metal cased filter condensers, 5 tubes, completely calibrated panel and detailed instruction manual. One of our best and most useful kits. Model G-2. Shipping Wt., 12 lbs.



\$34.50

THE NEW *Heathkit* HANDITESTER KIT

- Beautiful streamline Bakelite case.
- AC and DC ranges to 5,000 Volts.
- 1% Precision ceramic resistors.
- Convenient thumb type adjust control.
- 400 Microampere meter movement.
- Quality Bradley AC rectifier.
- Multiplying type ohms ranges.
- All the convenient ranges 10-30-300-1,000-5,000 Volts.
- Large quality 3" built-in meter.



\$13.50

A precision portable volt-ohm-milliammeter. An ideal instrument for students, radio service, experimenters, hobbyists, electricians, mechanics, etc. Rugged 400 ua meter movement. Twelve complete ranges, precision dividers for accuracy. Easily assembled from complete instructions and pictorial diagrams. An hour of assembly saves one-half the cost. Order today. Model M-1. Shipping Wt., 2 lbs.

NEW *Heathkit* BATTERY ELIMINATOR KIT

Features

- Provides variable DC voltage for all checks.
- Voltmeter for accurate check.
- Locates sticky vibrators-intermittents.
- Has 4000 MFD Mallory filter for ripple-free voltage.

Even the smallest shop can afford the Heathkit Battery Eliminator Kit. A few auto radio repair jobs will pay for it. It's fast for service, the voltage can be lowered to find sticky vibrators or raised to ferret out intermittents. Provides variable DC voltage 5 to 7½ Volts at 10 Amperes continuous or 15 Amperes intermittent. Also serves as storage battery charger. Ideal for all auto radio testing and demonstrating.



\$22.50

A well filtered rugged power supply uses heavy duty selenium rectifier, choke input filter with 4,000 MFD of electrolytic filter for clean DC. 0-15 V. voltmeter indicates output which is variable in eight steps. Easily constructed in a few hours from our instructions and diagrams — better be equipped for all types of service — it means more income. Model BE-2. Shipping Wt., 19 lbs.

YOU SAVE BY ORDERING DIRECT FROM MANUFACTURER—USE ORDER BLANK ON LAST PAGE

EXPORT AGENT
ROCKE INTERNATIONAL CORP.
13 E. 40th ST.
NEW YORK CITY (16)
CABLE: ARLAS-N.Y.

The **HEATH COMPANY**

... BENTON HARBOR 15, MICHIGAN

**New
LABORATORY
INSTRUMENT KITS**



**HUNDREDS OF LABORATORIES USE
Heathkit IMPEDANCE BRIDGE as Standard**

Features

- Measures inductance 10 microhenries to 100 henries • Measures resistance .01 ohms to 10 megohms • Measures capacitance .00001 MFD to 100 MFD • Measures "Q" and power factor.

Measures inductance from 10 microhenries to 100 henries, capacitance from .00001 MFD to 100 MFD. Resistance from .01 ohms to 10 megohms. Dissipation factor from .001 to 1. "Q" from 1 to 1,000. Ideal for schools, laboratories, service shops, serious experimenters. An impedance bridge for everyone — the most useful instrument of all, which heretofore has been out of the price range of serious experimenters and service shops. Now at the lowest price possible. All highest quality parts. General Radio main calibrated control. General Radio 1,000 cycle hummer. Mallory ceramic switches with 60 degree indexing — 200 microamp type binding posts with standard 3/4" centers. Beautiful birch cabinet. Directly calibrated "Q" and dissipation factor scales. Ready calibrated capacity and inductance standards of Silver Mica, accurate to 1/2 of 1% and with dissipation factors of less than 30 parts in one million. Provisions on panel for external generator and detector. Measure all your unknowns the way laboratories do — with a bridge for accuracy and speed.

\$69.50

Internal 6 Volt battery for resistance and hummer operations. Circuit utilizes Wheatstone, Hay and Maxwell circuits for different measurements. Supplied complete with every quality part — all calibrations completed and instruction manual for assembly and use. Deliveries are limited. Model IB-1. Shipping Wt., 15 lbs.

**NEW Heathkit LABORATORY
RESISTANCE DECADE KIT**

Features

- 1/2% Accuracy
- Birch Cabinet
- Ceramic Switches
- Covers 1 ohm to 99,999 ohms

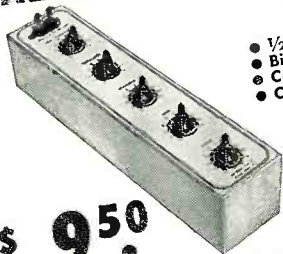

\$ 9.50

The new Heathkit Resistance Decade is a handy tool for laboratory, school and service shop. Ideal for test setups, calibrating instruments, bridge measurements, selecting multipliers, etc.

Uses the finest Centralab ceramic switches, 1/2% ceramic decade resistors and heavy birch cabinet matching other laboratory equipment. The range is 1 ohm to 99,999 ohms in one ohm steps.

Finest quality throughout to withstand school usage — heavy aluminum panel — laboratory type binding posts — the fine decades are extremely simple to assemble — complete kit. Model RD-1. Shipping Wt., 4 lbs.

**NEW Heathkit LABORATORY
POWER SUPPLY KIT**

Features

- Supplies 6.3 V. AC at 4.5 Amps.
- Heavy duty construction.
- Handy for schools, labs., and service shops.
- Supplies variable DC 50-300 Volts.
- Shows voltage or current on 3 1/2" meter.



\$29.50

This new Heathkit Variable Power Supply Kit fills hundreds of needs — use it for experimental circuits — no need to build a separate power supply — use it for a test voltage to determine proper coefficients in unknown circuits — calibrate instruments with its variable voltage, etc. This new Heathkit supplies 50 to 300 Volts continuously variable DC together with an AC filament voltage of 6.3 Volts at 4.5 Amperes. A built-in 1 MA 3 1/2" meter has proper shunts to read 0-500 Volts and 0-200 Milliamperes. The circuit uses a 5Y3 rectifier, two 1619 tubes as electronic control 7 1/8" x 13" x 7 1/8". Has instruction manual for assembly and use. Model PS-1. Shipping Wt., 18 lbs.

Heathkit RECEIVER & TUNER KITS for AM and FM

**TWO HIGH QUALITY Heathkit SUPERHETERODYNE
RECEIVER KITS**

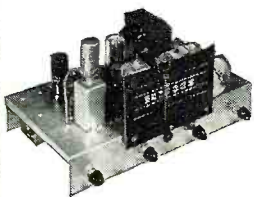

Model BR-1 Broadcast Model Kit covers 550 to 1600 Kc. Shipping Wt., 10 pounds.

\$19.50

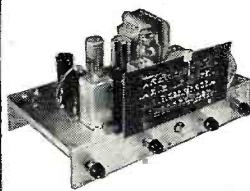

Model AR-1 3 Band Receiver Kit covers 550 Kc. to over 20 Mc. continuous. Extremely high sensitivity. Shipping Wt., 10 lbs.

\$23.50

Two new Heathkits. Ideal for schools, replacement of worn out receivers, amateurs and custom installations.

Both are transformer operated quality units. The best of materials are used throughout — six inch calibrated slide rule dial — quality power and output transformers — dual iron core shielded I.F. coils — metal filter condensers and all other parts. The chassis has phono input jack — 110 Volt outlet for phono motor and there is a phono-radio switch on panel. A large metal panel simplifying installation in used console cabinets is included. Comes complete with tubes and instruction manual incorporating pictorials and step-by-step instructions (less speaker and cabinet). The three band model has simple coil turret which is assembled separately for ease of construction.

**TRUE FM FROM Heathkit
FM TUNER KIT**

\$22.50



The Heathkit FM Tuner Model FM-2 was designed for best possible tonal reproduction. The circuit incorporates the most desirable FM features — true FM — ready wound and adjusted coils — 3 stages of 10.7 Mc. I.F. (including limiter).

Tube lineup: 7E5 oscillator, 6SH7 mixer, two 6SH7 I.F. stages, 6SH7 limiter, two 7C4 diodes as discriminator, 6X5 rectifier.

The instrument is transformer operated making it safe for connection to any type receiver or amplifier. The R.F. coils are ready wound — mounted on the tuning condenser and the condenser is adjusted — no R.F. coils to wind or adjust.

A calibrated six inch slide rule dial has vernier drive for easy tuning. The finest parts are provided with all tubes, punched and formed chassis, transformers, condensers and complete instruction manual. Model FM-2. Shipping Wt., 10 lbs.

EXPORT AGENT
ROCKE INTERNATIONAL CORP.
13 E. 40th ST.
NEW YORK CITY (16)
CABLE: ARLAB-N.Y.

The HEATH COMPANY

... BENTON HARBOR 15, MICHIGAN

ENJOY MUSIC AT ITS *Finest* WITH *Heathkit* AMPLIFIERS

NEW *Heathkit* HIGH FIDELITY 20 WATT AMPLIFIER KIT



\$21.50

Features

- Push-pull 6L6's.
- Full 20 Watts output.
- Fully enclosed chassis.
- Provisions for reluctance pickup compensation stage.
- Cased high fidelity output transformer.
- Treble and bass boost tone controls.
- Full range of output impedances 3.2 ohms to 500 ohms.

The finest amplifier kit we have ever offered — check the features. This inexpensive amplifier compares favorably with instruments costing five times as much. Nothing has been spared to provide the best reproduction — an ideal amplifier for the new Heathkit FM Tuner listed below.

Dual tone controls for control of both treble and bass. Bass control is of the boost type for maximum listening pleasure. Optional preamplifier stage for use with G. E. reluctance pickup or microphone. Uses inverse feedback to give excellent response over entire range. Tube lineup: 6SJ7 preamplifier stage, 6J5 phase splitter stage, two 6L6's in push-pull and 5Y3 rectifier. (6SC7 as optional compensation stage).

Uses highest quality Chicago Transformer Corporation cased output transformer with taps of 3.2, 8, 15, 60 and 500 ohms to match any speaker combination. Power transformer is conservatively rated for continuous operation in sound systems. Tone control gives maximum bass boost of 6 db at 70 cycles. Amplifier has maximum gain of 75 db. Response within 3 db 20 to 20,000 cycles. Shipping Wt., 17 lbs. Complete with all parts, tubes and instruction manual.

Model A-5A Amplifier with preamplifier for G. E. cartridges or microphone **\$23.50**
12" 20 Watt Speaker, No. 326..... **7.50**

Heathkit ECONOMY 6 WATT PUSH-PULL AMPLIFIER KIT



\$12.50

No. 304,
12-inch Speaker... **\$6.95**

This new Heathkit Amplifier was designed to give quality reproduction at a very low price. Has two preamp stages, complete with six tubes, quality output transformer (to 3-4 ohm voice coil), husky cased power transformer and all other parts. Has tone and volume controls. Instruction manual flat $\pm 1\frac{1}{2}$ db from 50 to 15,000 cycles. A quality amplifier kit at new low price. Better build one. Model A-4. Shipping Wt., 7 lbs.

Heathkit RECEIVERS and TUNER CABINETS



\$4.95

Order No. 350 for FM tuner

Blonde birch veneer cabinet for either the receivers or tuner. Modern styling is an asset to any room. 5" speaker fits in end of cabinet when used with receivers. Size 7 x 13½ x 8¼ inches. Shipping Wt., 5 lbs.
Order No. 345 for either receiver

Metal professional type communications receiver cabinet. Finished in deep grey to fit the panel supplied with Heathkit BR-1 and AR-1 Receivers (panel shown not included with cabinet). 5" speaker mounts in end of cabinet. Gives professional appearance to Heathkit receivers. Size 7 x 14 x 7¾ inches. Shipping Wt., 6 lbs.

5" Permoflux Speaker for either cabinet for use with either Heathkit Receiver No. 320 5" Speaker..... **\$2.75**

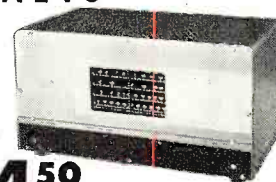

\$4.50

No. 355 Cabinet for receivers only.

ORDER BLANK

7c HEATH COMPANY
BENTON HARBOR 15,
MICHIGAN

From _____

SHIP VIA

- Parcel Post
- Express
- Freight
- Best Way

(PLEASE PRINT)

Quantity	Item	Price	Quantity	Item	Price
	Heathkit Oscilloscope Kit — Model O-6			Heathkit VTVM Kit — Model V-4A	
	Heathkit T.V. Alignment Gen. Kit — TS-2			Heathkit R.F. Probe Kit — No. 309	
	Heathkit FM Tuner Kit — FM-2			Heathkit H.V. Probe Kit — No. 336	
	Heathkit Broadcast Receiver Kit — Model BR-1			Heathkit R.F. Signal Gen. Kit — Model SG-6	
	Heathkit Three Band Receiver Kit — Model AR-1			Heathkit Condenser Checker Kit — Model C-2	
	Heathkit Amplifier Kit — Model A-4			Heathkit Handitester Kit — Model M-1	
	Heathkit Amplifier Kit — Model A-5 (or A-5A)			Heathkit Variable Power Supply Kit — Model PS-1	
	Heathkit Tube Checker Kit — Model TC-1			Heathkit Resistance Decade Kit — Model RD-1	
	Heathkit Audio Generator Kit — Model G-2			Heathkit Impedance Bridge Kit — Model IB-1	
	Heathkit Battery Eliminator Kit — Model BE-2			Heathkit Signal Tracer Kit — Model T-2	
	Heathkit Electronic Switch Kit — Model S-2				

On Parcel Post Orders, include postage for weight shown and insurance. (We insure all shipments.)

On Express Orders, do not include transportation charges — they will be collected by the Express Agency at time of delivery.

Enclosed find Check Money Order for _____

Please ship C.O.D. Postage enclosed for _____ lbs.

EXPORT AGENT
ROCKE INTERNATIONAL CORP.
12 E. 40th ST.
NEW YORK CITY (16)
CABLE: ARLAB, N.Y.

The HEATH COMPANY

... BENTON HARBOR 15, MICHIGAN

Wide Range Reproduction for the Home!!

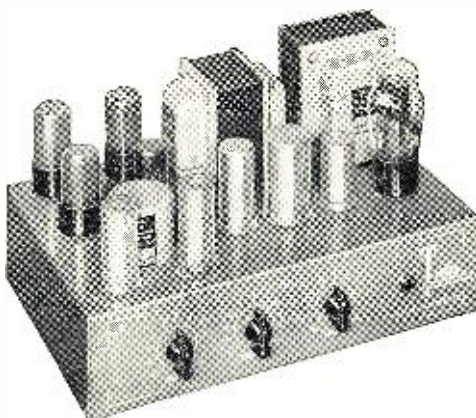

Triad Hi-Fidelity Amplifier Kit...

The Triad HF-10 Amplifier, from a circuit designed in cooperation with J. N. A. Hawkins, prominent sound engineer, has been produced especially for those who like to build their own sound reproducing systems. When used with the high quality speakers, tuners, turntables, and pick-ups now available, a system can be built that will meet the requirements of even the most critical music lover. The Triad HF-10 kit supplies the basic engineering and solves the most difficult mechanical layout problems. With 18 db. of feedback, affording a reflected impedance of less than 2 ohms to the 16 ohm speaker tap, within 1 db. linear frequency response from 20 to 20,000 cycles, and with a minimum of distortion over this same range, the HF-10 is worthy of use in the very finest home music installations.

* Features...

- Wide Frequency Response:** Within one db. from 20-20,000 cycles.
- Low Distortion:** Less than 2% from 50-18,000 cycles at full 10 watts output. Less than 1% from 20-20,000 cycles at 5 watts.
- Heavy Speaker Damping:** Reflects less than 2 ohms to speaker from 16 ohm tap.
- Equalization:** Continuously variable to +12 db. or -30 db. at 50 or 8000 cycles.
- High Gain:** 74 db. from crystal microphone or radio receiver; 96 db. (equalized for magnetic pickup) through preamplifier.
- Low Noise:** Hum and other noise 60 db. below maximum output. A-74J equalizing coil has 70 db. shielding.
- Beautiful Appearance:** Gray hammertone chassis with ivory silk-screened lettering, matching gray Triad transformers.

* Prices...

- HF-10 Kit**—Includes S-31A, R-14A, A-74J, and C-10X Triad transformers, chassis, prints and assembly instructions. **List Price \$39.85**
- HF-10A Kit**—Same as above except for substitution of HS-81 output transformer for S-31A. **List Price \$57.75**

Displayed in Room 530, Audio Fair, Hotel New Yorker, Oct. 26, 27, 28. See your dealer or write for Bulletin HF-10, and Catalog TR-49A which describes the complete Triad line.

2254 Sepulveda Blvd.
Los Angeles 64, Calif.



DB. and VU. Meters (Continued from page 86)

In the diagram a 500 ohm and a 15 ohm circuit are shown. It will be noted that the same amount of power is being dissipated in both circuits; however, the voltage across the circuits is not the same. If a power level meter, calibrated for 500 ohms, is placed across the 500 ohm circuit, it will be deflected to its zero reference mark. Connecting the same meter across the 15 ohm circuit will cause it to read low by 15.22 db. This is true because for the same amount of power the voltage across the 15 ohm circuit is only .3 volt. Thus the meter will not be deflected the same amount as for the 500 ohm circuit where 1.73 volts may be obtained.

The correction factor for any impedance may be obtained with the aid of the following equation: $db. correction = 10 \log_{10} (Z_1/Z_2)$ (or $10 \log_{10} (Z_2/Z_1)$ if the impedance of the circuit is higher than that for which the meter was calibrated) where Z_1 is the impedance for which the meter is calibrated and Z_2 the impedance to be bridged.

As an example, assume that a db. meter calibrated for 500 ohms is connected across a line impedance of 8 ohms with its attenuator set to zero. The signal deflects the pointer to the zero mark. What is the true power level of the circuit? It is $db. = 10 \log_{10} (Z_1/Z_2) = 10 \log_{10} (500/8) = 10 \log_{10} 62.5 = 10 \times 1.796 = 17.96$ db.

The correction factor 17.96 db. is added to the meter reading, thus when the meter indicates zero the true level is +17.96 db. If the meter is placed across an impedance higher than that for which it was originally calibrated, the second equation is used and the correction factor is subtracted from the meter reading. The most commonly used correction factors are given in Table 1.

When a meter is bridged across a circuit a slight power loss takes place. This is called "bridging loss." To determine how much the circuit level will be affected when the meter is bridged across it, the following equation may be used: $db. = 20 \log_{10} [(2BR + R)/2BR]$ where BR is the meter impedance and R is the impedance of the circuit bridged.

For example, assume a v.i. meter of 5000 ohms is bridged across a circuit of 500 ohms. What is the bridging loss

Table 1. The most commonly used correction factors for power level meters.

CORRECTION FACTORS		
LINE Z (in ohms)	METER CAL. (500 ohms) (in db.)	METER CAL. (600 ohms) (in db.)
600	-0.791	0.000
500	0.000	+0.791
250	+3.01	+3.80
200	+3.97	+4.77
125	+6.02	+6.81
100	+6.99	+7.78
50	+10.00	+10.79
30	+12.22	+13.01
15	+15.22	+16.02
8	+17.96	+18.75
4	+20.97	+21.76

Are You Preparing for a Good Paying Job in TV-Electronics?



Whether you're headed for Essential Industry—or the Armed Services—CREI Technical Training qualifies you for more interesting jobs at better pay!

Television technicians are in demand in stations, factories, research labs; in installation and trouble-shooting jobs. In the Armed Services, the men who know electronics are sure of interesting, supervisory jobs.

CREI Home Study can help you step ahead!

By **E. H. RIETZKE**
President CREI

YOUR future success can best be assured by the steps you take today to prepare for it. No field offers a properly qualified young man greater opportunity than electronics. In the Armed Services, electronics gives rockets "brains" to make scientific observations, gives airplanes "eyes" and "ears" to navigate, gives explosives target directions.

In industry, electronics prepares the vast number of devices utilized by the Armed Services—the countless radars, two-way radios, and communications equipment used by modern armies, fleets, and planes. In peace, electronics provides good jobs for trained engineers and technicians. Television's fantastic growth from 10,000 sets in 1945 to 8 million by the end of 1950—with set production currently at the rate of 6 million—is typical of the speed at which the electronics band-wagon is moving. It is the *new* field, where know-how is rewarded with excellent jobs and lifetime careers. And authorities are agreed that the one sure way to acquire this training is from a good school.

How can a young man select a "good school?" By its reputation in the industry . . . the professional standing of its faculty . . . the quality of its courses . . . the length of time it has been in existence . . . and its accomplishments.

CREI invites investigation and

comparison. An accredited technical institute founded in 1927, CREI's home-study graduates today fill important engineering, research, and radio-TV posts through the industry. While CREI makes no job promises to its graduates, the Placement Bureau generally has on hand more requests than it can fill. During World War II CREI trained thousands of technicians for the Army, Navy and Coast Guard. Hundreds of thousands of special CREI technical texts were used in the Navy's own training program. Leading industrial firms—RCA Victor, United Air Lines, TWA, Pan American Airways, All America Cables & Radio, Inc., Sears Roebuck & Co., to name only a few—have selected CREI for technical training for their technicians *at company expense*.

CREI, through home study, offers *practical* training that starts with basic principles and goes step-by-step through the more advanced subjects

of TV and its related fields. Each student is grounded thoroughly in the fundamentals required for development work in TV, guided missiles, communications and industrial electronics. You study Optics; Pulse Techniques; Deflection Circuits; RF, IF, AF and Video Amplifiers; FM; Receiving Antennas; Power Supplies; Cathode Ray, Iconoscope, Image Orthicon and Projection Tubes; UHF Techniques, TV Test Equipment, and many other subjects.

There are three basic CREI courses: Practical Radio Engineering (fundamental course in all phases of radio-electronics); Practical Television Engineering (specialized training for professional radiomen); Television and FM Servicing (streamlined course for men in top third of field). Courses are also available at the Residence School in Washington, D. C.

Write immediately for complete information. The cost is within reach of all, the terms easy. *Mail this coupon at once.*

CAPITOL RADIO ENGINEERING INSTITUTE

Dept. 1111B, 16th & Park Rd., N. W., Washington 10, D. C.

Gentlemen: Send booklet, "Your Future in the New World of Electronics," together with details of your home study training, CREI self-improvement program and outline of course. I am attaching a brief resume of my experience, education and present position.

Check the Field of Greatest Interest: PRACTICAL TELEVISION ENGINEERING. PRACTICAL RADIO ENGINEERING. TV, FM & ADVANCED AM SERVICING. AERONAUTICAL RADIO ENGINEERING. BROADCAST RADIO ENGINEERING (AM, FM, TV). RADIO-ELECTRONICS IN INDUSTRY.

NAME.....AGE.....

ADDRESS.....

CITY.....ZONE.....STATE.....

If Residence School in Washington, D. C. preferred, check here



REVOLUTIONARY

GIVES YOU

maximum replacement

WITH A

minimum of cartridges!

THIS MEANS MONEY TO YOU!

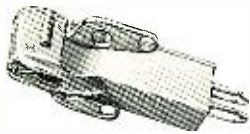

ORTHOGONAL SERIES 32, 33 and 34

This TORQUE DRIVE* vertical-type crystal cartridge is being used more and more in original equipment and for replacement. The 32 series greatly improves 78 rpm reproduction—saves record wear. The 34 series for 33½ and 45 rpm beautifully plays the new wide-range, high fidelity recordings—tracks perfectly at 5 grams pressure. The 33 series handles all three speeds, with remarkable efficiency. All specially moisture protected for extra long life. Has ½" and ⅝" hole spacing. Color coded. Simple to install. Replaceable osmium-tip or sapphire-tip needles.

*E-V Pat. Pend. Licensed under Brush patents.

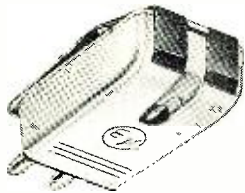

SERIES 12 and 14

The Series 12 TORQUE DRIVE crystal cartridge replaces over 150 types in general use for 78 rpm. Saves time and work—speeds servicing. Gives better reproduction and longer record life. Series 14 for 33½ and 45 rpm is performing brilliantly in thousands of record changers. Tracks perfectly at 5 grams pressure. Color coded. Replaceable osmium-tip or sapphire-tip needle.

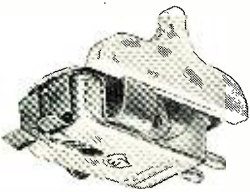

SERIES 16 TWILT FOR ALL 3 SPEEDS

Superbly plays 33½, 45 and 78 rpm records with a single twin-tip replaceable needle without weight change, with tracking pressure of only 6 grams, and does it with TORQUE DRIVE efficiency. You merely tilt the Twilt and select the 1-mil or 3-mil needle tip for fast or slow speed records. Setdown is accurate. Mounts easily in most any standard pickup arm, with nothing more required than reducing needle pressure. Also available without tilting mechanism.



SERIES 60 REPLACES OVER 20

New Econo-Cartridge for economical replacement of over 20 conventional Bimorph crystal types. Frequency response to 6000 cps. Output is 3.5 volts with compliant needle, and 4.5-5 volts with straight shank needle. Has exclusive E-V needle stop which prevents chuck from rotating excessively and damaging crystal.

Electro-Voice INCORPORATED

410 CARROLL STREET • BUCHANAN, MICHIGAN

Export: 13 East 40th Street, New York 16, N.Y., U.S.A. Cable: Arlab
Research-Engineered Phono Pickups, Microphones, High-Fidelity Speakers

ASK YOUR E-V
DISTRIBUTOR OR
WRITE FOR
FREE BULLETINS

BRIDGING LOSSES		
METER Z (in ohms)	LINE Z (in ohms)	BRIDGING LOSS (in db.)
5000	500	0.42
5000	600	0.51
7500	500	0.28
7500	600	0.34
10,000	500	0.21
10,000	600	0.26

Table 2. Tabulation of bridging losses for lines of different impedances and volume indicator meters of various bridging impedances. See text for the related formulas.

in decibels? It is $db. = 20 \log_{10} [(2BR + R)/2BR] = 20 \log_{10} [(10,000 + 500)/10,000] = 20 \log_{10} 1.05 = 20 \times .0212 = .424$ db. Thus, when the meter is bridged across the circuit the original level will be lowered by .424 db. Generally speaking, unless very precise measurements are to be made, this small loss in level may be ignored. Bridging losses for lines of different impedances and v.i. meters of various bridging impedances are shown in Table 2.

The difference in decibels between any two reference levels may be determined by the equation $db. = 10 \log_{10} P_1/P_2$. For example, the difference between a reference level of 1 milliwatt and one of 6 milliwatts would be: $db. = 10 \log_{10} P_1/P_2 = 10 \log_{10} 6/1 = 10 \log_{10} 6 = 10 \times .778 = 7.78$ db.

Conclusion

In closing it might be well to mention that copper-oxide rectifier meters, irrespective of type, will at times introduce distortion into the circuit being bridged, if used in conjunction with distortion measuring equipment. The vu. attenuator should be set to its maximum position after the proper level has been obtained and then the distortion reading should be taken.

The distortion introduced by the vu. meter is caused by the rectifier clipping the peaks of the impressed waveforms. The amount of distortion introduced will depend on how much isolation is provided by the attenuator network resistance.

Another precaution which should be taken is that since the vu. meter is designed to be mounted on dural or aluminum panels because of the high coercive force magnet used in the movement, the shunting effect of the steel on the magnetic circuit reduces the flux and affects the meter characteristics if the meters are mounted on steel panels.

-30-



4 Pages of TEST EQUIPMENT at prices every serviceman can afford!

MONEY BACK?

Every single unit described on this and the following pages is offered on a strict "money-back-if-not-satisfied-basis." No ifs—no but's—no maybe's. Simply send your order for any

unit or units you select and try them out for 10 days. If not completely satisfied—return for refund in full. No explanation necessary. You are sole judge.

GUARANTEE?

Every instrument sold by us is covered by a one-year guarantee. Guarantee registration card is included with shipment.

KITS?

We have discontinued advertising TEST EQUIPMENT in Kit form. The units offered on these 4 pages are completed instruments, NOT KITS! Every model is factory-wired, calibrated and ready to operate.

TUBE TESTERS

THE NEW MODEL 247



Check octals, loctals, bantam jr., peanuts, television miniatures, magic eye, hearing aids, thyratrons, the new type H.F. miniatures, etc.

Features:

★ A newly designed element selector switch reduces the possibility of obsolescence to an absolute minimum.

★ When checking Diode, Triode and Pentode sections of multi-purpose tubes, sections can be tested individually. A special isolating circuit allows each

section to be tested as if it were in a separate envelope.

★ The Model 247 provides a supersensitive method of checking for shorts and leakages up to 5 Megohms between any and all of the terminals.

★ One of the most important improvements, we believe, is the fact that the 4-position fast-action snap switches are all numbered in exact accordance with the standard R.M.A. numbering system. Thus, if the element terminating in pin No. 7 of a tube is under test, button No. 7 is used for that test.

Model 247 comes complete with new speed-read chart. Comes housed in handsome hand-rubbed oak cabinet sloped for bench use. A slip-on portable hinged cover is indicated for outside use. Size: 10³/₄"x8³/₄"x5³/₄".

\$29⁹⁰
NET

SUPERIOR'S NEW MODEL TV-10



★ Tests all tubes including 4, 5, 6, 7, Octal, Lock-in, Peanut, Bantam, Hearing-Aid, Thyratron, Miniatures, Sub-Miniatures, Novals, etc. Will also test Pilot Lights.

★ Tests by the well-established emission method for tube quality, directly read on the scale of the meter.

★ Tests for "shorts" and "leakages" up to 5 Megohms.

★ Uses the new self-cleaning Lever Action Switches for individual element testing. Because all elements are numbered according to pin-number in the RMA base number

system, the user can instantly identify which element is under test. Tubes having tapped filaments and tubes with filaments terminating in more than one pin are truly tested with the Model TV-10 as any of the pins may be placed in the neutral position when necessary.

★ The TV-10 does not use any combination type sockets. Instead individual sockets are used for each type of tube. Thus it is impossible to damage a tube by inserting it in the wrong socket.

★ Newly designed Line Voltage Control compensates for variation of any line voltage between 105 Volts and 130 Volts.

★ Free-moving built-in roll chart with complete data on all tubes.

The Model TV-10 operates on 105-130 Volt 60 Cycles A.C. Comes housed in a beautiful hand-rubbed oak cabinet complete with portable cover.

\$39⁵⁰
NET

TO ORDER—TURN TO PAGE 100 FOR RUSH ORDER FORM

GENERAL ELECTRONIC DISTRIBUTING CO.

DEPT. RN-11, 98 PARK PLACE

NEW YORK 7, N. Y.

1

BUY WITH CONFIDENCE!!

WE KNOW THE PRICE IS UNBELIEVABLY LOW...

But that's not all! In addition, this finely engineered instrument provides a degree of accuracy never before attained in a unit selling for even double this price. Furthermore—in designing this unit, we took advantage of every recent improvement in components. For example, by using slug-tuned coils, we are able to efficiently adjust each instrument for

perfect accuracy. This feature will also enable you to recalibrate the model 200 periodically without having to return it to the factory. The use of a Noval tube (the 12AU7) with its extremely low inter-electrode capacity enabled us to reach a higher frequency range than was heretofore possible in a unit of this type.

THE NEW MODEL 200 **AM and FM** **SIGNAL GENERATOR**

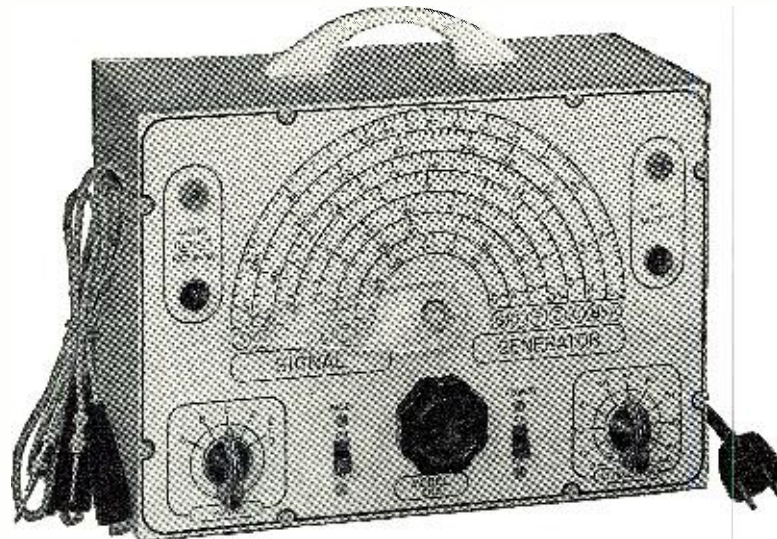

SPECIFICATIONS

- ★ **R.F. FREQUENCY RANGES:** 100 Kilocycles to 150 Megacycles.
- ★ **MODULATING FREQUENCY:** 400 Cycles. May be used for modulating the R. F. signal. Also available separately.
- ★ **ATTENUATION:** The constant impedance attenuator is isolated from the oscillating circuit by the buffer tube. Output impedance of this model is only 100 ohms. This low impedance reduces losses in the output cable.
- ★ **OSCILLATORY CIRCUIT:** Hartley oscillator with cathode follower buffer tube. Frequency stability is assured by modulating the buffer tube.
- ★ **ACCURACY:** Use of high-Q permeability, tuned coils adjusted against 1/10th of 1% standards assures an accuracy of 1% on all ranges from 100 Kilocycles to 10 Megacycles and an accuracy of 2% on the higher frequencies.
- ★ **TUBES USED:** 12AU7—One section is used as oscillator and the second is modulated cathode follower. T-2 is used as modulator. 6C4 is used as rectifier.

The Model 200 operates on 110 Volts A.C. Comes complete with output cable and operating instructions.

\$ **18⁸⁵**
NET

2

TO ORDER—TURN TO PAGE 100 FOR RUSH ORDER FORM

GENERAL ELECTRONIC DISTRIBUTING CO.

DEPT. RN-11, 98 PARK PLACE, NEW YORK 7, N. Y.

MONEY BACK GUARANTEE!!

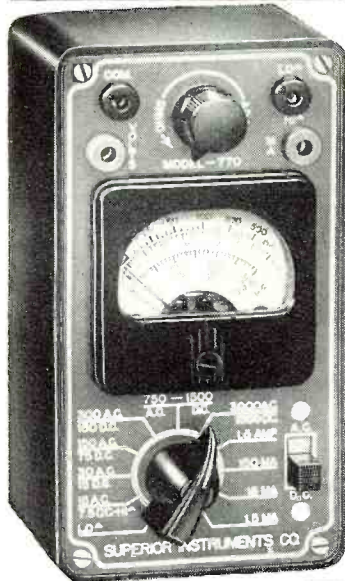

SUPERIOR'S new model 770 AN ACCURATE POCKET-SIZE VOLT-OHM MILLIAMMETER

(SENSITIVITY: 1000 OHMS PER VOLT)

FEATURES

- ★ Compact-measure 3 1/8" x 5 7/8" x 2 1/4".
- ★ Uses latest design 2% accurate 1 Mil. D'Arsonval type meter.
- ★ Same zero adjustment holds for both resistance ranges. It is not necessary to readjust when switching from one resistance range to another. This is an important time-saving feature never before included in a V.O.M. in this price range.

★ Housed in round-cornered, molded case.

★ Beautiful black etched panel. Depressed letters filled with permanent white, insures long-life even with constant use.

The Model 770 comes complete with self-contained batteries, test leads and all operating instructions.

SPECIFICATIONS

- | | |
|--|---|
| 6 A.C. VOLTAGE RANGES:
0—15/30/150/300/1500/3000 VOLTS | 4 D.C. CURRENT RANGES:
0—1.5/15/150 MA. 0—1.5 AMPS. |
| 6 D.C. VOLTAGE RANGES:
0—7.5/15/75/150/750/1500 VOLTS | 2 RESISTANCE RANGES:
0—500 OHMS 0—1 MEGOHM |

\$13.90
NET



SUPERIOR'S new model 670 SUPER-METER A COMBINATION VOLT-OHM MILLIAMMETER PLUS CAPACITY REACTANCE INDUCTANCE AND DECIBEL MEASUREMENTS

SPECIFICATIONS:

- D.C. VOLTS:** 0 to 7.5/15/75/150/750/1,500/7,500 Volts
- A.C. VOLTS:** 0 to 15/30/150/300/1,500/3,000 Volts
- OUTPUT VOLTS:** 0 to 15/30/150/300/1,500/3,000 Volts
- D.C. CURRENT:** 0 to 1.5/15/150 Ma. 0 to 1.5 Amperes
- RESISTANCE:** 0 to 500/100,000 Ohms 0 to 10 Megohms
- CAPACITY:** .001 to .2 Mfd. .1 to 4 Mfd. (Quality test for electrolytics)
- REACTANCE:** 700 to 27,000 Ohms 13,000 Ohms to 3 Megohms

INDUCTANCE: 1.75 to 70 Henries 35 to 8,000 Henries

DECIBELS: —10 to +18 +10 to +38 +30 to +58

ADDED FEATURE:

The Model 670 includes a special GOOD-BAD scale for checking the quality of electrolytic condensers at a test potential of 150 Volts.

The Model 670 comes housed in a rugged, crackle-finished steel cabinet complete with test leads and operating instructions. Size 5 1/2" x 7 1/2" x 3".

\$28.40
NET

SUPERIOR'S
new model TV-20

20,000 OHMS PER VOLT MULTI-METER and TELEVISION KILOVOLT METER

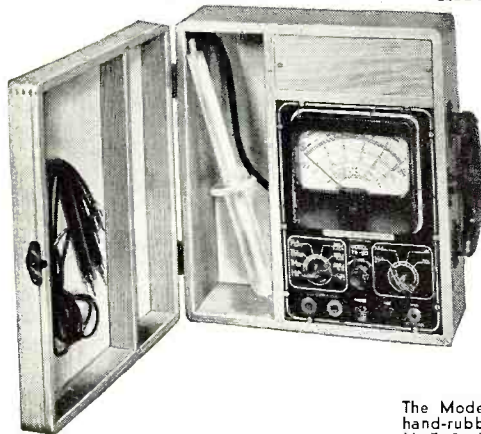

SPECIFICATIONS

- 9 D. C. VOLTAGE RANGES: (At 20,000 ohms per Volt)
0-2.5/10/50/100/250/500/1,000/5,000/50,000 Volts
- 8 A. C. VOLTAGE RANGES: (At 1,000 ohms per Volt)
0-2.5/10/50/100/250/500/1,000/5,000 Volts
- 5 D. C. CURRENT RANGES
0-50 Microamperes
0-5/50/500 Milliamperes
0-5 Amperes
- 4 RESISTANCE RANGES:
0-2,000/20,000 ohms 0-2/20 Megohms
- 7 D. B. RANGES: (All D. B. ranges based on
Odb = 1 Mv. into a 600 ohm line)
— 4 to +10 db + 36 to +50 db
+ 8 to +22 db + 42 to +56 db
+ 22 to +36 db + 48 to +62 db
+ 28 to +42 db
- 7 OUTPUT VOLTAGE RANGES:
0 to 2.5/10/50/100/250/500/1,000 Volts

ADDED FEATURE:

The Model TV-20 includes an Ultra High Frequency Voltmeter Probe. A Silicon V. H. F. Diode together with a resistance capacity network provides a frequency range up to 1,000 MEGACYCLES. When plugged into the Model TV-20, the V. H. Probe converts the unit into a Negative Peak-Reading H. F. Voltmeter which will measure gain and loss in all circuits including F. M. and T. V.; check capacity and impedance; test efficiency of all oscillator circuits; measure band-width of F. M. and T. V.; etc.

\$39.95
NET

The Model TV-20 operates on self-contained batteries. Comes housed in beautiful hand-rubbed oak cabinet complete with portable cover. Built-in High Voltage Probe, H. F. Probe, Test Leads and all operating instructions. Measures 4 1/2" x 10 1/4" x 11 1/2". Shipping Weight 10 lbs.

TO ORDER—TURN TO PAGE 100 FOR RUSH ORDER FORM

GENERAL ELECTRONIC DISTRIBUTING CO.

93 PARK PLACE

DEPT. RN-11

NEW YORK 7, N. Y.

3

Superior's model CA-12

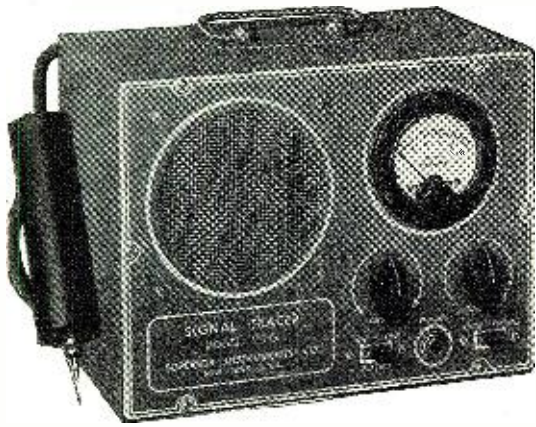

MODEL CA-12 COMES COMPLETE WITH ALL LEADS AND OPERATING INSTRUCTIONS

SIGNAL TRACER

THE WELL KNOWN MODEL CA-12 IS THE ONLY SIGNAL TRACER IN THE LOW PRICE RANGE INCLUDING BOTH METER AND SPEAKER!!!

SPECIFICATIONS

- ★ Comparative Intensity of the signal is read directly on the meter—quality of the signal is heard in the speaker.
- ★ Simple to Operate—only one connecting cable—no tuning controls.
- ★ Highly Sensitive—uses an improved vacuum-tube voltmeter circuit.
- ★ Tube and Resistor Capacity Network are built into the detector probe.
- ★ Built-in High Gain Amplifier—Alnico V Speaker.
- ★ Completely Portable—weighs 8 pounds—measures 5 1/2" x 6 1/2" x 9".

\$29.95
NET

Superior's new model TV-30

TELEVISION SIGNAL GENERATOR

ENABLES ALIGNMENT OF TELEVISION I. F. AND FRONT ENDS WITHOUT THE USE OF AN OSCILLOSCOPE!



FEATURES Built-in modulator may be used to modulate the R. F. Frequency, also to localize the cause of trouble in the audio circuits of T. V. Receivers.

Double shielding of oscillatory circuit assures stability and reduces radiation to absolute minimum. Provision made for external modulation by A. F. or R. F. source to provide frequency modulation. All I. F. frequencies and 2 to 13 channel frequencies are calibrated direct in Megacycles on the Vernier dial. Markers for the Video and Audio carriers within their respective channels are also calibrated on the dial.

Linear calibrations throughout are achieved by the use of a Straight Line Frequency Variable Condenser together with a permeability trimmed coil.

Stability assured by cathode follower buffer tube and double shielding of component parts.

SPECIFICATIONS Frequency Range: 4 Bands—No switching; 18-32 Mc., 35-65 Mc., 54-98 Mc., 150-250 Mc.

Audio Modulating Frequency: 400 cycles (Sine Wave). Attenuator: 4 position, ladder type with constant impedance control for fine adjustment. Tubes Used: 6C4 as Cathode follower and modulated buffer. 6C4 as R.F. Oscillator. 6SN7 as Audio Oscillator and power rectifier.

Model TV-30 comes complete with shielded co-axial lead and all operating instructions. Measure 6" x 7" x 9". Shipping Weight 10 lbs.

\$29.95
NET

**RUSH
ORDER
FORM**

**CUT
OUT
AND
MAIL
TODAY!**

GENERAL ELECTRONIC DISTRIBUTING CO.
DEPT. RN-11, 98 PARK PLACE, NEW YORK 7, N. Y.
GENTLEMEN:

PLEASE RUSH THE MATERIAL LISTED BELOW:

QUANTITY	MODEL	PRICE

TOTAL

\$.....(Payment in Full Enclosed)

\$.....(Deposit Enclosed—Ship Balance C.O.D.)

SHIP TO:

Name

Address

City Zone State

4

For additional information on any of the items described herein, readers are asked to write direct to the manufacturer. By mentioning RADIO & TELEVISION NEWS, the page, and the issue number, delay will be avoided.

SWR BRIDGE

A new and compact standing wave ratio bridge has been designed and is being produced by *James Millen Manufacturing Company, Inc.* of Malden, Massachusetts.

Designated Catalogue number 90671, the new bridge is of the resistance



type and is intended to be used with coaxial lines of either the 52 or 75 ohm type. The compact size of the bridge, 4 1/4" x 2 1/4" x 1 5/8", makes it convenient to use in almost any location. It will work with any low range d.c. instrument such as a 0-1 milliammeter thus making possible an inexpensive means for obtaining certain necessary transmitter measurements.

REGULATED POWER SUPPLY

Kepeco Laboratories, Inc. of 149-14 41st Ave., Flushing, New York, has recently introduced a new voltage regulated power supply, the Model 515.

The new instrument features one regulated "B" supply, one regulated "C" supply, and one unregulated filament supply. The "B" supply is continuously variable from 0 to 500 volts and delivers from 0 to 200 ma. In the range 20 to 500 volts the output volt-

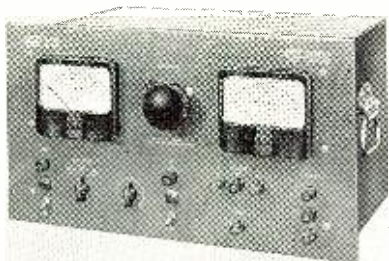

age variation is less than 1/2% for both line fluctuations from 105 to 125 volts and load variations from minimum to maximum current. Ripple is less than 5 millivolts.

The "C" supply is continuously variable from 0 to 150 volts and delivers 5 ma. For all output voltages the output voltage variation is less than 10 millivolts for line fluctuations of 105

to 125 volts. At 150 volts, the regulation is less than 1/2% between 0 and 5 ma. At other settings below 150 volts the internal resistance of the supply will increase to a maximum of 25,000 ohms. Ripple is less than 5 millivolts. The a.c. output is 6.3 volts, 10 amperes, center-tapped and unregulated.

The power supply is designed for relay rack mounting or bench use. It measures 19" wide, 10 1/2" high, and 13" deep.

TUBE PULLERS

Macgowan Electric Specialty Company of 5040 Thomas Avenue So., Minneapolis 10, Minnesota, is currently in production on a handy tube puller designed for the service technician.

Available in four models, the "EE-Zee" tube pullers lift out tubes by wedging between the base and socket without applying strain to the glass. Tubes are held securely while extracting and there is no need to touch hot

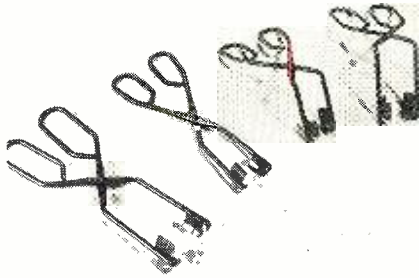

tubes. The puller will also extract small vibrators and pull knobs.

The large straight and angle models handle metal, GT, loctal, and most regular glass tubes, while the small straight and angle models handle the miniature type tubes.

Additional details and prices are available on request from the company.

STORAGE BINS

In the interest of speeding servicing operations, facilitating ordering, and increasing the sale of small parts and fixtures, *Service Parts Systems* of 4607 St. Aubin Street, Detroit, Michigan, has recently introduced two new service bins.

The 700 bin is a wall unit with 100 separate compartments. All are tilted forward to meet the eye and are built on the "cash drawer" principle with rounded bottoms to make parts easier to pick out. Each compartment carries a bin tag holder for labels of part number, price, and specifications. The wall unit is 56 inches high, 44 inches wide, and 12 inches thick at the base.

USE PHOTOFAC

the world's best Radio-TV service data—it pays for itself every working day



Try PHOTOFAC!

FREE We'll send you any Photofact Folder listed in the Photofact Cumulative Index

WE'LL PROVE YOU'LL SAVE TIME and EARN MORE WITH PHOTOFAC

NOW—learn for yourself—at our expense—how PHOTOFAC makes your Radio and TV work *quicker, easier, more profitable!* Examine an actual PHOTOFAC Folder. Use it. You'll learn first-hand why over 35,000 successful service technicians use PHOTOFAC daily. You'll learn that no other service gives you PHOTOFAC's *completeness, accuracy, uniformity, and lowest cost.* PHOTOFAC is the *only* radio and TV service data prepared from laboratory analysis of the actual equipment. Know the facts—get your FREE Folder now. Examine, use, compare—learn why no modern service shop can afford to be without PHOTOFAC!

WRITE FOR FREE INDEX

PAY AS YOU EARN! Ask your distributor about this amazing plan. Only \$18.39 puts the entire profit-boosting Photofact library in your shop now!

NOTE: Our FREE Folder offer is limited to Service Technicians only. Attach coupon below to your letterhead and mention your jobber's name. If you have no letterhead, send coupon to your jobber. Experimenters and others may obtain the Photofact Folder by remitting amount shown below.

HOWARD W. SAMS & CO., INC.
2201 E. 46th St., Indianapolis 5, Ind.

- Send FREE Photofact Cumulative Index
 Send Full Easy-Pay Details

I am a Service Technician:

- Send FREE Folder for set model.....

I am an Experimenter: Enclosed \$.....

- Send Folder for set model.....
TV-\$1.00. Record Changer or Comm. Receiver-75c. AM/TM-50c

Name.....

Address.....

City.....Zone...State.....

ODDS 'N ENDS SALE

DIEHL MOTOR



Fan duty, brushless induction type (no TV interference). For 115 VAC 60 cycles. 46 watt. 1800 R.P.M. Shaft 1/4" diam. 1" long. Noiseless ball-bearings—heavy cast construction. Shpg. wt. 6 lbs.

Brand new.....\$4.50

SILVER CERAMIC TRIMMERS

5-20 Mmfd. Zero Temp.....24c
5-20 Mmfd. Neg. 300.....24c
4.5-25 Mmfd. Zero Temp.....24c
20-125 Mmfd. Neg. 630.....33c

MISCELLANEOUS—LIMITED QUANTITIES

Grain-O-Wheat Bulbs, type 323, 3 volts. Doz. \$1.50
Westinghouse Mtr. multipl. res. 1/4 meg. 1/2 meg. .89
Circuit Breaker, 10 Ampere thermal.....50
140 mmdf air trimmers, screwdriver adjust.....35
Weston 506 2 1/2" rd. 0-15 ma. Brand New.....2.95
Shunt 50 mv. 150 Amps. Westinghouse.....2.00
Ceramic couplings 1/4" to 1/2"......25
Micro-switch YZ-R85 SPST (N.O.)......25
8 MFD 660 VAC Oil Condenser C-D.....3.50
2 X .1 MFD 600 V. Bathub C-D......25
1/32 Ampere SAG Littelfuse..... per doz. 1.00
.5 MFD 400 VDC rectangular Oil Aerovox......35
Guardian Relay 24 VDC 8 Ohm coil 1/4" silver contacts, aircraft starting.....1.95
8 MFD 3000 V. Pk. Foto-flash cond. Sprague.....2.49
Phase Inverter MC-413-A FTR.....5.00
40 MFD 150 VDC PF electrolytic......20
40 MFD 450 VDC PF electrolytic......35
Thordarson Choke 10 Hys 55 ma. fully cased......85

DC POWER SUPPLY



Limited quantity—Gov't Surplus. Ready to operate. Full wave bridge copper-oxide rectifier heavy duty multi-tapped transformer.

Input: 85/95/105/115/VAC 50/60 cps.
Output: 2.5/24/28/32/36 VDC at 5 amperes, unfiltered.

For wall or bench mounting. Overall dimen. 9"x8 1/2"x8 1/2" high. Shpg. wt. 30 lbs. Tested and guaranteed.....\$36.00
Filter Kit, 2% ripple.....6.65

WHILE THEY LAST METER SPECIAL



0-300 VDC. Basic 0-1 ma. 2 1/4" rd. Bakelite case. New, in original boxes. Shpg. wt. 2 lbs.
Bargain price.....\$2.25

SELENIUM RECTIFIERS

and associated transformers, filter chokes and condensers are listed in our Catalog No. 719. Write for your copy.

VACUUM CAPACITORS



Standard Bra nds
12 Mmfd. 20 Kv \$4.95
50 Mmfd. 32 Kv 5.95
Overall length 6 1/2", diameter 2 3/4", terminal diameter 3/8". Shpg. wt. 2 lbs.

EDISON THERMO TIME DELAY RELAY

Heater voltage 115 V. Norm. open SPST contacts. 15-30 sec. delay. Contact rating 115 V. 3A., 440 V. 2A. Size 3 3/4"x1 1/2" diam. Plug in type for standard 4-prong tube base. Each.....98c

HI-VOLTAGE!

Oil condenser, voltage doubler type 2X .15 MFD-8000 VDC. Use both sections in parallel for .3 MFD 8 KV, or in series for .075 MFD 16 KV. G.E. 26F 381 New, Each.....\$3.25
Lots of 6
in orig. box Each.....\$3.00



TEST EQUIPMENT

TS-34AP Oscilloscope, like new with cords, probe, carrying case and technical manual. Price on request.
Leeds & Northrup Capacitor Decade, Cat. No. 1071. Price on request.

General Radio Variable Condenser 722-D. Dual range 110 MMFD and 1100 MMFD with hardwood case.....\$85.00

Industrial Instruments Decade Resistor Type DR50 11,111 Ohms total in steps of .1 Ohm, like new \$25.00

AUDIO CHOKE

SM Choke Type U7402 Hermetically sealed.
50 Hys. .04 Amps DC
1780 RMS Test Voltage 3 1/2"x3 1/2"x3 1/2". Shpg. wt. 6 lbs.....\$2.25



PILOT LIGHT ASSEMBLIES

Aircraft type, panel mounting, amber jewel only. Knurled rim, controls "Dim-Bright." Bakelite and aluminum construction. Bulb replaceable from front panel. For single contact bayonet bulbs. T-3 1/2" or G-3 1/2" size. Dimensions: 2 1/2" overall length, 3 1/4" diameter. 5/8" panel mtg. hole.



IMMEDIATE DELIVERY—500 to carton, nested. \$50.00 per carton. Prices on larger quantities on request.

WESTINGHOUSE AIRCRAFT MOTOR

Brand new—24 VDC reversible. 1/50 H.P. 4800 RPM continuous duty. Length of leads 18". Dimensions 3 1/2"x2 1/2", shaft 1/4" diam. by 3/5" long.



Price.....\$2.95
Reversing switch with "off" position. Each.....79c

Minimum order \$5.00. All prices are FOB shipping point. Send check or MO. We will ship transportation charges collect. Rated concerns send P.O.. Terms Net 10 days.

The 320 bin is an island unit with compartments on both sides of the stand. It provides 320 separate compartments in a unit measuring 65 inches high, 44 inches wide, and 20 inches thick at the base.

All the compartments in both units



lift from the rack for stock rotation and cleaning. Shelves at the top and bottom of the wall unit provide extra space for storage of packaged goods. Both bins are built of 18 and 20 gauge steel and are painted in buff and maroon.

VOLTAGE REGULATORS

A new series of line adjusters has been recently introduced by Standard Transformer Corporation of 3580 N. Elston Avenue, Chicago 18, Illinois.

These four units permit operation of electrical devices at 115 volts when the supplied voltage is 65, 75, 90, 100, 115, 130, or 145. They meet power requirements up to 750 va., 50-60 cycles. The line adjuster input is correctable in seven steps by means of a selector switch and indicated by an output voltmeter.

The new units are also useful for altering a 115 volt line above or below



that level. They come equipped with a line cord and plug to fit a standard outlet and a plug-in receptacle to accommodate devices to be operated.

TUBE TESTER KIT

To assist service technicians and dealers in marketing radio tubes, Electronic Instrument Co., Inc., of 276 Newport Street, Brooklyn 12, New York, has just introduced a new counter-display tube tester kit, the Model 625-CK.

The new merchandiser, which features individual switches for separate testing of every tube element, tests conventional receiving and TV tubes including 4, 5, 6, large and small 7, octal, loctal, noval, Hytron, VR, magic
(Continued on page 144)

OPAD-GREEN COMPANY

71-3 WARREN ST., NEW YORK 7, N. Y. PHONE: BEkman 3-7385-6

NOW!
AT Hy-Grade!

the SKY-HIGHEST VALUE in Television Today!

World Famous Quality

630

TV CHASSIS
only

\$153.00
less CRT

Yes, you can believe your eyes! Here's the exact duplicate of the incomparable RCA 630TS Circuit—television's unmatched standard for super-sensitivity and stability—now with all the newest features of trigger-fast Keyed AGC, Voltage Doubler, Standard Tuner, molded condensers, plus the finest quality components, Yoke, Focus Coil, Mounting Brackets, plus 30 tubes. Supplies 13 to 14KV underload for full brilliance and width for all rectangular and round 12 1/2, 16 and 19" tubes. At only \$153.00 this is the TV super-value you can't afford to miss! Order several NOW! Immediate Delivery! 2.5% deposit with order, balance C.O.D., f.o.b., Brooklyn, N. Y.



for SKY-HY VALUES
at rock-bottom costs—
it's HY-GRADE!

Hy-Grade Electronics, inc.

1509 EAST NEW YORK AVE., BROOKLYN 12, N. Y.

National Distributors
of Electronic Parts
and Equipment

When television won its wings

How multiple uses for airborne cameras and equipment were revealed by experiment

No. 10 in a series outlining high points in television history

Photos from the historical collection of RCA

● Put a television camera in the nose of an observation plane, and generals—many miles away—can watch and direct the course of a battle. Such, in World War II, was one of the suggested uses of airborne television as an “optic nerve.”

Feasible? Absolutely—yet this is only one of the many ways in which television can serve in fields outside those of news and entertainment. The entire subject of the use of television cameras and receivers in the air has been carefully investigated by RCA.

Not too long ago, at the time when plans for our inter-city television networks were in discussion, the

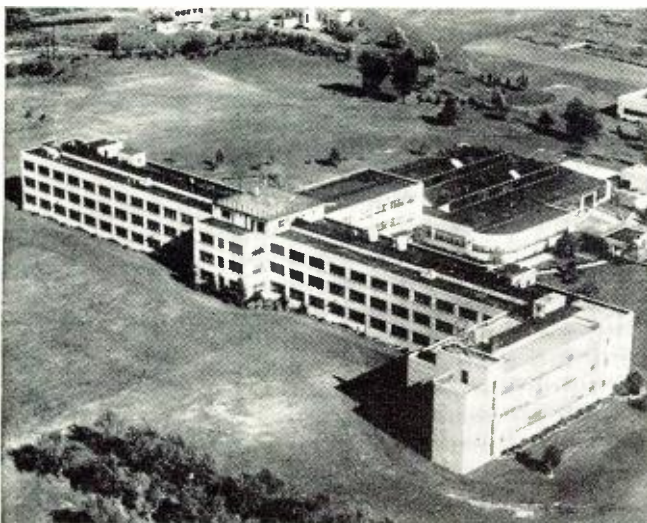

RCA Laboratories in Princeton, N. J., as seen from the air. New uses for television—including, for example, its adaptation to aviation—are one part of this progressive institution's research program. November, 1950



Mounted in the nose of an airplane, special RCA airborne television equipment will give ground observers a sharp, clear, bird's-eye view of land and sea.

idea of making telecasts from planes high in the air was proposed.

From New York, a plane equipped with a television receiver, set off on a flight to Washington—200 miles away. When above Washington, at an altitude of 18,000 feet, passengers in the plane clearly saw Brig. General David Sarnoff, of RCA, talking to them from Radio City! Later, RCA placed a camera and transmitting equipment in an airliner, and a bird's-eye view of New York was successfully telecast to observers below!

It has also been proposed by authorities, that a television camera might be used as the “eye” of a guided missile. Placed in a rocket's nose it would let a distant operator see where the missile was headed. If need be he could steer it in any direction to hit a moving target.

But less on the destructive side, and more important to us now, are the possible uses of television in “blind flying” conditions, when airports would normally be closed in from bad weather. With a television receiver in the cockpit, and a transmitter sending information from the landing field ahead, the pilot could clearly see conditions on runways and approaches—come in with far greater security than when guided by radio alone!



Radio Corporation of America
WORLD LEADER IN RADIO—FIRST IN TELEVISION

McGEE'S 20TH ANNIVERSARY SALE IS NOW ON—LOOK TO McGEE FOR VALUES
NEW 1951 MODEL 12-INCH "COAXIAL" SPEAKER!

- WIDE RANGE RESPONSE—40 to 17,500 CPS.
- ONLY 2 WIRES TO CONNECT TO ANY AMP OR RADIO
- NEW HEAVY DUTY CONSTRUCTION



"WHY PAY MORE?"

SALE PRICE **\$12⁹⁵**

McGee announces our new 1951 model 12-inch coaxial speaker, designed for the critical music listener; for use with high fidelity audio systems. It is improved over our last model in that the 12" woofer now has a heavy duty 31 oz. Alnico 3 magnet. This reproduces the lower musical register down to 40 cycles! The coaxially suspended tweeter has a specially designed cone for the higher register of music and voice. It will respond up to 17,500 CPS. The high pass filter is attached and combined impedance will hook up to any 8 ohm output transformer. It will connect in place of any ordinary speaker (only 2 wires to connect). Why pay \$20 to \$40 for a speaker? McGee has made it to their own specifications. By the thousands and passes the savings on to you. We have sold over 10,000 coaxial speakers. Why pay more than McGee's price? McGee's 12" 20 watt wide range coaxial PM speaker, Model CU-14X. Net price, \$12.95; 2 for \$25.00. Shipping weight 10 lbs.

SUPER HEAVY DUTY 10" PM \$4.95

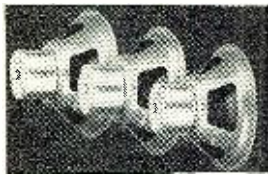

We made a special purchase on several hundred 20 watt 10" 32 oz. Alnico 3 magnet PM speakers. Deep throat and easy moving cone. Ideal for all high fidelity sound systems and radio replacement. The magnet on this speaker is usually used on a 15" size. Very efficient, good high and bass response. You'll appreciate it when you get your hands on this speaker. Attractive corner finish, 8 ohm voice coil. Stock No. 1025PS. Weight 7 lbs. Net price \$4.95 each.

Order three of these and use them in a cluster of three. They will take 60 watts of audio and have more cone area than your 15" speaker. For high power, top quality P.A. work. Think this over. 3 No. 1025PS speakers for only \$13.95.

REG. \$54.00 LIST 25 WATT DRIVER AND TRUMPET \$23.95

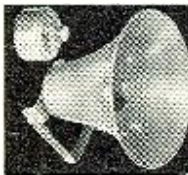

This trumpet and driver is especially designed for all outdoor speaker uses; churches, sound trucks, etc. It is the most popular size sold today. McGee offers you more for your money. Each speaker is fully guaranteed.

Model X-100 all weather proof 3 1/2 foot trumpet, made of aluminum castings and spinners. 19" bell trumpet can be used with any standard driver. Regular \$29.00 list. Ship. weight 15 lbs. Net price \$13.50. Model RM-30, standard 15 ohm, 25 watt driver for use with above trumpet. Quality second to none. Shipping weight 6 lbs. Net \$12.50. Combination offer. Buy the X-100 trumpet and RM-30 25 watt driver, both for \$23.95.



10 WATT PAGING SPEAKER \$11.95

Model 10-XXP, 10 watt paging speaker with built-in 1 1/2-in. weather proof driver. Spun aluminum construction, 8 ohm voice coil. Regular net on this speaker is over \$15.00. A special purchase by McGee makes this \$11.95 price possible. Shipping weight 4 lbs.

HIGH FIDELITY OUTPUT TRANS. 20 20,000 CPS

Only\$6.95
BEST VALUE IN U.S.A.
 A-403—6600 ohms. Plate to Plate.

Why pay \$20.00 or \$30.00 for an output? Supreme quality and high fidelity output transformer. Designed to match push-pull plates (2-6L6, 2-6V6, or 2-6A05) class AB, to 4-8-15-250 and 500 ohm; with 10% feedback winding. Housed in aluminum plated case. 3 7/8 x 4 1/8". Actual net weight 6 lbs. If you want the best quality from your audio system, order this transformer. Response essentially flat from 20 to 20,000 cycles. We have tried several high fidelity outputs in our lab and find this to be the best value. Even though your amplifier only puts out 10 or 15 watts, this 34 watt job is what you should have. Connecting instructions are furnished. Stock No. A-403, shipping weight 8 lbs. Net price...\$6.95

10" HEAVY DUTY P.M. WITH RED HOT SPECIAL \$7.49



Super heavy duty 10" 32 oz. Alnico 3 PM speaker, with 8 ohm voice coil. Ideal for music box operators and all sound installations. A lucky purchase makes this unusual value possible. The baffle is of the conventional slanting wall type mounting, made of plywood and covered with leatherette. Stock No. MP-10. Net price \$7.49 each. In lots of 3 or more, \$7.00 each.

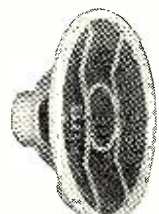

NEW 1951 MODEL 15" "COAXIAL" PM SPEAKER

20TH ANNIVERSARY SALE PRICE

\$17⁹⁵

McGee's new 1951 Model 15" coaxial PM speaker here! And at a price everyone can afford, \$17.95. This speaker is ideal for all types of radio and audio amplifier use. It may be connected to any 8 ohm output transformer. The 15" woofer has a 32 oz. Alnico 3 magnet and the coaxially suspended tweeter has its own magnet and voice coil. A true coaxially built speaker. The high pass filter prevents low frequency notes from reaching the tweeter. The response of this 15" coaxial is from below 20 CPS to above 17,500 CPS. It is the best speaker value in the U.S. today. We buy these by the carload and pass our savings on to you. If you have or are building one of our high fidelity amplifier kits, this speaker is the one you should have. It is a tremendous value. Why pay more than McGee's price, for a 15" coaxial PM speaker? Stock No. P15-9. Shipping weight 14 lbs. 20th Anniversary sale price \$17.95 each, 2 for \$34.00.

20TH ANNIVERSARY INTERCOM SALE!

\$25,000 WORTH OF INTERCOMS AT SCOOP PRICES

5-STATION INTERCOM MASTER

MASTER STATION **\$1495**
 SUB STATION **\$395** EACH

5 station intercom master station, in an attractive walnut cabinet, 10x5 1/2x8". 5 pushbuttons, you can call any one or more substations. Talk-listen switch has a silent position. You have control of the panel for easy access. The amplifier is of the conventional AC-DC design, with plenty of power. Equipped with a full size Alnico V magnet intercom master is new 1950 production by a well known factory. Made to sell at a much higher price. Only 300 to sell this special purchase price. \$14.95 each. 5 station intercom master No. 2700. Weight 7 lbs. Net price \$14.95.

Molded walnut plastic substations for use with Model 2700 Master. Full size Alnico V magnet PM speaker, spring return call-back switch, size 5 1/2 x 8 1/4 x 3 1/4". Shipping weight 2 lbs. each. Mounts either on the wall or may be set on a desk. Very attractive. Net price \$3.95 each. 5 for \$18.95. 3-wire plastic intercom cable, 1000 ft. \$4.00, 500 ft. \$7.50, 1000 ft. \$12.60.

10-STATION A.C. MASTER STATION \$24.95



- Powerful—6V6 Output Tube
- Walnut Vernier Cabinet
- Push Button Selector
- Sub Stations \$3.95 Each

Super heavy duty, 10 station intercom master, designed for continuous service. A powerful AC transformer type with rectifier, 6V6 output driver, 5" speaker with 2.15 oz. Alnico V magnet. Housed in a walnut cabinet 14" long, 9 1/2" deep and 7 1/2" high. Designed to sell for a much higher price. McGee made a fortunate purchase and passes the bargain on to you. Shipping weight 12 lbs. Stock No. 2520. Net \$24.95 each. We have a few Model 2520. Built for Master to Master use. Price on Master to Master \$25.95.

Attractive walnut plastic cabinet, sub station for use with the model 2520 master. Has lever acting call back switch and Alnico V PM speaker. Net price \$3.95 each, 10 for \$37.50. 3 conductor plastic intercom cable, \$1.50 per 100 ft. 500 ft. \$7.50, 1000 ft. \$12.60.

Our Leader Changer Scoop \$10.95, 2 for \$20.90



Our leader, automatic changer scoop. Base size 13 x 13". Plays 10 1/2" or 12 1/2" 78 RPM records automatically. Has Astatic L-10 cartridge. Prices complete with a metal base, which can be used in slide away compartment or as a table top base, or changer can be lifted off base to suit needs. Stock No. AD-12. Shipping weight 17 lbs. Scoop price \$10.95 each.

1950 MODEL TAPE RECORDER \$79.95



Our brand new 1950 model portable tape recorder. Reel-to-reel. 8000 CPS. With this you make and record your own recordings. Tape speed, 7 1/2 in. per second. New mechanism records 1 hour on 1200 ft. reel of tape. Fast rewind, record 30 minutes, turn spool over and record second 30 minutes on 1200 ft. reel. Has an AC transformer type amplifier with 6" speaker. Inputs for mike and radio. External speaker jack. Price includes 30 minute reel of tape and mike. Hinged lid is removable. Case is attractive leatherette covered. Size 10x13x14". Shipping weight 29 lbs. Stock No. FLT-3. Net price \$79.95.

S-56 HALLICRAFTERS

11-TUBE FM-AM CUSTOM CHASSIS. A \$110.00 VALUE \$59.95 AT McGEE FOR ONLY . . .

- WIDE RANGE • AUTOMATIC FREQUENCY

Receives 88 to 108 MC FM, and Broadcast 550 to 1650 K.C.
 Fine for Custom Installation
 Model S-56 Hallicrafter, 11 tube AM-FM radio receiver chassis for broadcast and FM 88 to 108 mc. Automatic frequency control on FM, holds the receiver in position on rear of base to suit output of chassis. Full range tone control with bass boost. Push-pull 6R6 tubes in audio system. Frequency response essentially flat, from 50 to 14,000 CPS. Wide vision accurately calibrated slide rule dial, with pre-selection on broadcast band. Output transformer matches any 8 ohm speaker. 4 antenna terminals, two for AM and two for FM. This is the finest type of home radio that we know of today. Better get your order in early. Designed to be used in commercial radio selling in the \$400 to \$600 class. The regular dealer's net on this chassis is \$110.00. However, a lucky purchase enables us to offer these brand new, factory cartoned S-56 Hallicrafters, complete with tubes and operating instructions, at only \$59.95 less speaker. Chassis size 12 1/2 x 10 x 7 1/2. Weight 2 1/2 lbs. Brand new factory cartoned. Buy your S-56 with a wide range PM speaker.

Pre-amplifier for S-56 \$3.95

Dual purpose pre-amplifier for either S-56. Only 4 wires to connect (instructions furnished). Size 1 1/2 x 1 1/2 x 1 1/2 in. This you can convert set to operate either a G.E. variable reluctance pick-up or a crystal or dynamic mike, making your S-56 a home P.A. system. Preamp Model SS-69, 1 1/2 x 1 1/2 x 3 1/2. Shipping weight 2 lbs. Net price, \$3.95. Crystal mike and desk stand, \$4.95 extra.

MODEL CN-1232 12 INCH 25 WATT PM \$5.95
 Another McGee red hot special 12" 32 oz. Alnico 3 ring magnet PM, 8 ohm voice coil speaker. Made by Consolidated. A regular \$17.00 list. Shipping weight 15 lbs. Net price, \$5.95 each, 4 for \$22.00.

78 R.P.M. RECORD PLAYER \$11.95
 Self-Contained Amplifier and Speaker. Here is a red hot value. A complete self-contained 78 rpm record player with its own amplifier, built in. It has a 1.5 oz. Alnico V PM speaker. Extra heavy duty 78 rpm phono motor. The amp and speaker are concealed under the attractive plastic base. This is a complete built-up player and has better tone and more power than you would expect from a player of its size. Only 100 to sell. Stock No. E-100P. Sale price, \$11.95.

G.E. RECORD PLAYER ATTACHMENTS SALE PRICE \$6.95
 General Elec. 78 RPM Record Players to attach to any radio or amplifier. Heavy duty crystal phono pick-up. Volume control and off-on switch. Shpg. weight 8 lbs. (No pre-amp necessary.) 78 RPM Model, Stock No. GE-33, \$6.95. 33 1/3 RPM Model, Stock No. GE-33 has Webster crystal pick-up with needle. Net, \$6.95. Buy 3 for \$19.50.

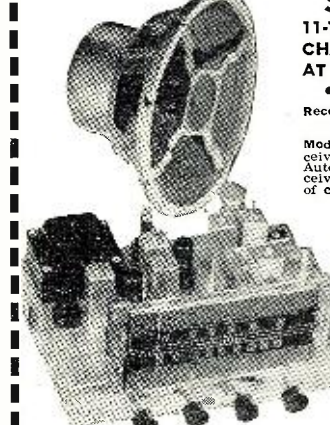

S-56 chassis with our \$32.50 list 12" coaxial (CU-14X) PM speaker, both for \$69.50.
 S-56 chassis with our Model P15-9 15" coaxial speaker. Both for \$75.95.
 S-56 chassis with our new 12" curvilinear cone (1202-X) PM speaker, both for \$67.95.
 VM-950 Tri-O-Matic, 3 speed changer \$28.35.
 VM-930-GE, 3 speed changer with new GE RFX-050 V.R. cartridge \$31.27.

BUILD A HI-FIDELITY AMPLIFIER WITH A MCGEE KIT

COMPLETE 5-TUBE A.C. SELF-POWERED BROADCAST TUNER KIT
USE WITH ANY AMPLIFIER

A self powered, 3 gang superhet tuner kit, with R.F. stage. When wired according to our diagram will make the best possible broadcast tuner, (550 to 1650kc) for use with any amplifier. Has a G.E. lighted slide rule dial. Don't class this with ordinary tuners, this has its own transformer. The complete kit is furnished with a diagram and photo, with tubes: 6SK7 R.F., 6SA7 converter, 6XK7 I.F., 6IG detector, 6X4 rectifier. Connect to any audio amplifier. Ideal for use with our XX-34, TM-15 or S-2020 amp. kits. Chassis size: 9 1/2 x 8 1/2 x 4 1/2" high. Shipping weight 8 lbs. Broadcast tuner kit, Model BT-35. Net price \$11.95.

COMPLETE 18-WATT WIDE RANGE AMPLIFIER KIT
RESPONSE 20 TO 20,000 CPS.
INPUTS FOR—RADIO TUNER—MIKE AND RECORD PLAYER

This kit, when wired, will make a 20 to 20,000 CPS. wide range, all purpose, 18 watt music appreciation amplifier. Inputs for a radio tuner, crystal or dynamic mike and crystal phono pickup. Also, has preamplifier for GE, variable reluctance pickup. Nothing but the finest quality material is furnished with well regulated power supply. Separate base and trouble boost controls and fader circuit. Designed with convenient location. Photos and schematic furnished with this kit, will build the finest all purpose amp. complete with tubes, less speaker. Model S-2020. Shipping weight 16 lbs. Net price \$19.95. Crystal mike and desk stand \$4.95 extra.

BROADCAST QUALITY TRANSFORMER KIT

Response 18 to 22000 C.P.S. The Same Quality as Used in the Finest Quality Audio Amplifiers

Why Pay More **Sale Price \$11.95**



Here is the hottest transformer kit we have ever offered. Originally intended for use in the high priced, top grade amplifier. Made of the best possible material to give broadcast station frequency response: 18 to 22,000 CPS. A suggested diagram is furnished to build your own amplifier; with inputs for G.E. variable reluctance phono pickup, crystal phono pickup or radio tuner. Here are the transformer specifications: 18 to 22,000 CPS, matches 2-6V in push-pull (15-watts), output taps match 0 or 4 1/2" full, weight 8 1/4 lbs. This transformer is a fully shielded upright model, 3 1/2 x 4 1/2 x 4 1/2" tall, easy to hook up, full details included, which relieves 300 volts at 200 volt filament, (easy to hook up, full details included), which relieves 300 volts at 200 volt filament, with the best possible voltage regulation. Also has a 6.3 volt 3 amp. filament winding. The selenium rectifier comes in a full wave selenium vacuum tube, and is schematic. You get full description of the kit, including a suggested diagram of how to connect and also how to wire a 3 tube converter to enable the wire recorder to be used in conjunction with any radio or amplifier. St. George wire recording mechanism, Series 1100. Shipping weight 15 lbs. Net price \$19.95 each. Crystal phono pickup arm and cartridge \$1.95 extra. Recording wire: 15 minute \$1.79. Net price \$1.79. 1 hour 30 minute \$2.79. Crystal mike and desk stand \$4.95 extra.

\$19.95 BUYS A NEW St. George Wire Recording Mechanism

ONLY 200 TO SELL

McGee offers you at a terrific saving the St. George Series 1100 wire recording mechanism. Brand new and factory cartoned. This unit will record and playback from a standard recording wire, up to 1 hour. The wire take-up reel turns at 78 RPM. Also plays and records from a 78 RPM phonograph record. The base is punched for a phono pickup. Space required, 9x3x1 1/2". Shipped with a diagram of how to connect and also how to wire a 3 tube converter to enable the wire recorder to be used in conjunction with any radio or amplifier. St. George wire recording mechanism, Series 1100. Shipping weight 15 lbs. Net price \$19.95 each. Crystal phono pickup arm and cartridge \$1.95 extra. Recording wire: 15 minute \$1.79. Net price \$1.79. 1 hour 30 minute \$2.79. Crystal mike and desk stand \$4.95 extra.

RECORD PLAYER \$9.95 KIT

Complete record player kit, for 78 RPM records. All parts, tubes and diagram for building a 70L7 type amplifier. Attractive ready cut walnut base (speaker cut-out on top). Ballentine phono motor and Astatic pickup with permanent magnet. Shipping weight 10 lbs. Model No. MD-78. Net price \$9.95. Three-speed model No. D-3378, same as above only has 3 speed motor and fly weight crystal pick up arm with Universal 3-speed needle. Net price \$13.95.

10 OZ4 TUBES 10 4-PRONG VIBRATORS

ALL FOR **\$16.95**

RED HOT SPECIAL

Here's a red hot deal for you fellows that do a lot of auto radio service. Ten standard brand metal OZ4 tubes and 10 of our famous 4-prong serrated can vibrators. This vibrator is of the latest design, for long life. Standard diameter car, motorcycle, etc. Our 20th Anniversary, big deal No. RN-V10. You can get 10 OZ4 metal tubes and 10 4-prong vibrators, all for \$16.95. Shipping weight 5 lbs.

100 MOLDED PLASTIC BYPASSES \$8.95

100 molded plastic tubular by-pass condensers. All 600 volt. And all by the same nationally known mfr. Regular dealers net is over two and one half times our 20th Anniversary sale price. You'll chuckle when you look these over. Here's what you get: 10-.001, 10-.002, 20-.005, 20-.01, 20-.02, 10-.05 and 10-.1. Our big deal No. RN-202. 100 plastic tubulars. Shipping weight 2 lbs. Net price \$8.95.

1 or 4 VOLT CRYSTAL CARTRIDGES \$1.99

McGee offers you a famous make crystal cartridge. Standard size and shape, but very light weight. Will track on 34 oz. or more pressure. Stock A-6, 1/25 volt output, replaces Astatic L-70 etc., Net \$1.99. Stock No. A-10, 4 volt output, replaces Astatic L-72 and L-82, etc., Net \$1.99. Buy 10 assorted for \$19.00.

100 KNOBS Set-Screw Type 3.95

100 bakelite set screw knobs, for radio set replacement. All fit standard 1/4" shaft. Assorted walnut, black and ivory. Enough of each style to give you matched sets. This value worth \$7.50. Shipping weight 3 lbs. Deal No. RN-10K, 100 knobs. Net \$3.95.

SELENIUM RECTIFIERS

65 Mill Selenium Rectifier.....49c
 75 Mill Selenium Rectifier.....59c
 100 Mill Selenium Rectifier.....59c
 150 Mill Selenium Rectifier.....73c
 200 Mill Selenium Rectifier.....99c
 250 Mill Selenium Rectifier.....\$1.09
 Mc Gee's XX quality selenium rectifiers. Small size, compact construction. All 1950 production, by a No. 1 factory. Not surplus, but uniform quality. Fully guaranteed. 130 volt RMS rated.

Picture TUBES

16" 16JP4\$19.95
 12 1/2" 12LP4\$14.95

Number one quality television picture tubes. Guaranteed by us; unconditionally for 90 days. Best quality, with neutral or white face. Factory design changes made this value possible. Why pay more than McGee's price? Only 500 left to sell, 1000 already sold. No more will be available, when these are gone. 16 tube, weight 25 lbs. 12 1/2 tube, weight 19 lbs. Order now, these 12 and 16" tubes will replace most of the glass tubes types, 12RP4, 12" Aluminumized screen tube, 90 day guarantee, while 50 last. Net price \$14.95 each. 12LP4, 90 day guarantee, but slightly irregular, but give perfect picture, Net price \$11.95.

100 TOP QUALITY 600 VOLT TUBULARS \$5.95

100 top quality 600 volt tubular by-pass condensers. Made this year by a famous condenser factory. Don't confuse these with grab bag surplus. McGee's deals are guaranteed to please. Here's what you get: 10-.001, 10-.002, 20-.005, 20-.01, 10-.02, 20-.05 and 10-.1 600 volt condensers. Our big deal No. RN-208. Shipping weight 2 lbs. Net price \$5.95.

8-TUBE—ALL TRIODE-HI-FIDELITY 20-WATT AMPLIFIER KIT

MODEL TE5 29.95

CONTROLS—ON CHASSIS OR EXTENSION LEADS

A newly designed all triode amplifier kit, with separate base and trouble electronic tone compensation, to extend the frequency response from 20 to 20,000 CPS. Inputs for a radio tuner, crystal or Variable reluctance phono pickup and dynamic mike. Chassis size, 12 x 12". Controls may be mounted on the chassis, or on extension leads, so that you may install the amplifier in most any space available. All parts and tubes furnished including diagram, super high fidelity shielded output transformer matches any 8 ohm PM speaker. Power transformer is full size and is incorporated in the power supply. This is as fine an amplifier kit as we have ever made. Will get 20 watts output. Tubes furnished: 6-7E5, 6-7E7, 6-7E6 plus 5U4 rectifier. Shipping weight 20 lbs. Stock No. TE5, kit complete, Net price.....\$29.95

SARKES-TARZAIN 13-CHANNEL T.V. FRONT END WITH TUBES AND DIAGRAM \$7.95

This popular Sarkes-Tarzain television front end is widely used today. The 13 channel rotary switch type with individually tuned coils. Price includes a schematic diagram and 3 tubes, 6C4 osc, 6IH6 RF and 6AG2 mixer. Regular factory cost is twice our price. Each tuner and tube set furnished and are wired, ready to hook up to a video and intercarrier or separate sound IF circuits. Built-in fine frequency control. Ship. weight 3 lbs. Sarkes-Tarzain Type 2 TV tuner with tubes net.....\$7.95
 Combination deal, Sarkes-Tarzain TV tuner and 205-XX video coil kit both for.....\$14.95
 Sarkes-Tarzain Type 3—Same as Type 2 only has input IF coil built-in. Tapped for sound IF channel. Net.....\$9.95
 Sarkes-Tarzain Type 3 tuner and 205-XX coil kit both for.....\$16.95

TELEVISION VIDEO COIL KIT—20 MATCHED COILS FOR PICTURE AND SEPARATE SOUND I.F. \$7.95

Order with a Sarkes-Tarzain Front End for \$14.95
 20 matched TV coils; video and sound I.F. McGee Scorp price \$7.95. Television video coil kit, for TV sets up to 16", using separate sound and picture circuits. Consists of 20 coils for use in the nationally famous 30 tube and 22 tube TV circuit. All coils are of the finest construction, furnished to you, just like they go to a TV set maker. Each coil is identified. These are not made by RCA, but by a top quality coil company, especially for McGee. If you are going to use the RCA circuit, you can use this set of coils.
 Coil kit has 1-180 uh, 1-250 uh, 2-120 uh, 2-93 uh speaking coils, 4 picture IF coils for 21.75 mc, 1 cathode trap, 2 sound IF's 21.25 mc, 1 discriminator, 1 converter and 5 filament chokes. Stock No. 205-XX, shipping weight 3 lbs. McGee's price \$7.95.

BRAND NEW GENERAL INST. TELEVISION FRONT END-TUNERS \$7.95

A special purchase of brand new General Instrument T.V. tuners makes our \$7.95 price possible. They have never been in sets or soldered to. All completely wired, brand new and pre-aligned. 13 channel selector incorporating fixed inductance and variable capacitance. Converter output transformer is attached to be coupled direct to separate sound and video I.F.'s. 3 6J6 tubes are required. Shaft length 2 1/4". Built in fine frequency control. We have only a limited stock of these to offer at \$7.95. Original factory cost over \$20.00. Shipping weight 4 lbs. Stock No. GI-13P, less tubes. Net price \$7.95. Two for \$14.95.

REG. \$20.58 MASCO T.V. BOOSTER FOR \$13.39

Masco MTB-13X, 13 channel television booster. A regular \$20.58 dealers net. Item on sale at McGee for only \$13.39. Housed in an attractive metal cabinet, 5 1/2 x 5 1/2 x 5 1/2". Self powered, operates on 110 volts AC. Priced complete with 2-6AK5 tubes. These boosters are available and factory cartoned. Shipping weight 6 lbs. McGee's sale price only \$13.39 each. Two for \$25.00. The price is good only as long as our supplies last.

BRAND NEW R. C. A. TELEVISION FRONT END-TUNERS \$14.95

A fortunate purchase from a T.V. set manufacturer makes this value possible. RCA 13 channel completely wired, tested and aligned T.V. tuner. A 13 channel selector switch with outer sleeve fine frequency control. Converter output transformer is attached for direct coupling to video and sound I.F. stages. Shaft length, 3 3/4". Original dealer's cost on this item was over \$30.00. McGee's big deal on this brand new (they have never been soldered to or in sets) for only \$14.95, less tubes, over \$30.00 required. Shipping weight 2 lbs. Stock No. RCA-13P, less 3 6J6 tubes. Net \$14.95, two for \$27.95.

20 SELENIUM RECTIFIERS \$9.95

20 top quality selenium rectifiers. Guaranteed 2nd to none. Latest compact construction. All standard 130 volt. Use these for your AC-DC sets when tubes are hard to get. 10-65 mill and 10-100 mill selenium rectifiers. McGee's big deal No. RN-208. Shipping weight 2 lbs. Net price \$9.95.

McGEE RADIO COMPANY Prices F.O.B. K.C. Send 25% Deposit with Order, Balance Sent C.O.D. With Parcel Post Orders, Include Postage. **TELEPHONE VICTOR 9045. WRITE FOR FLYER 1422 GRAND AVE., KANSAS CITY, MISSOURI**

The MIKE On MATTERHORN

By
KENNETH J. HENDERSON
Swiss Shortwave Service, Berne

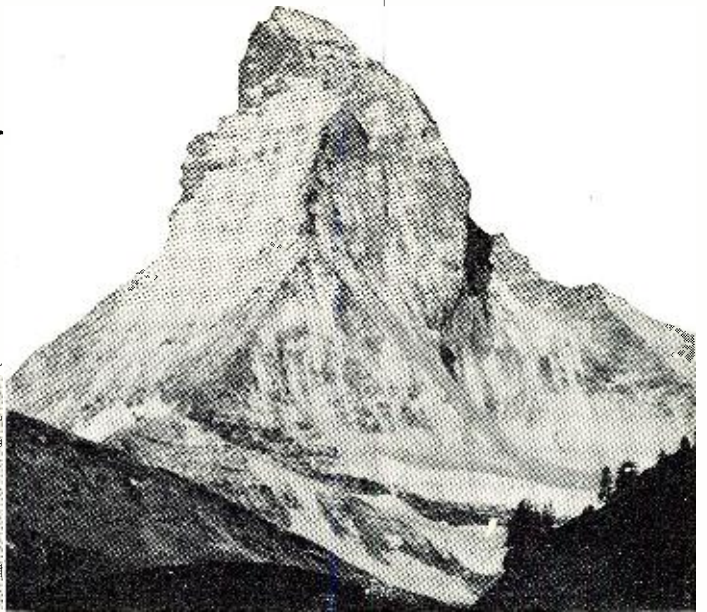

Matterhorn, scene of the unique broadcast described in this article. Directly in front of photograph is the N.E. arête up which the broadcasting party climbed this 15,000 foot peak.



Broadcasting from a precarious foothold on the way up. Center, John Lamb looks over his notes while Edouard Merinat (top, left) gets in transceiver communication with the base as the guide holds the antenna mast. Below the mast is the tiny transmitter.

SHORT-WAVE enthusiasts throughout the world were privileged to hear a unique broadcast early in August when the *Swiss Broadcasting Corporation* scheduled a transmission from Matterhorn, 15,000 foot giant in southern Switzerland.

Long dreamed of by Swiss radio men, the stupendous feat was made possible by the use of modern ultra short-wave transmitting apparatus, much of it especially designed and constructed for the broadcast. Marcel Chasset, HB9FE of Fribourg, Switzerland, assembled two 6C4 units which measured 15.6 cm. square (approximately $6\frac{3}{16}$ " square) and 15 cm. deep (approximately 6"). Input was 2 watts and the tubes were plate modulated. The crystal microphone amplifier was an A/W 16-A G5 and a 6AK6 tube was used as a modulator. The whole unit weighed 2.900 kilograms (about $6\frac{3}{4}$ pounds) and was powered by two 120 volt storage batteries coupled in series. Filament power was supplied by a 6 volt storage battery of the M/C type.

Chasset was faced with a tough problem since the apparatus had to be light enough to carry at high altitudes, tough enough to stand up under the physical shocks it would receive during the gruelling climb, and finally, well

The "inside story" of a history-making event, unique in the annals of radio.

enough constructed to withstand sudden and extreme changes in temperature and pressure. In addition to these requirements the equipment had to provide broadcast quality over a distance of six kilometers (about 4 miles).

The folded dipole antenna, designed for use with the transmitters, consisted of three pieces—the masts were made of two plastic tubes which screwed into each other while the crosspiece was of light wood, hinged in the middle so that it could be stowed in the haversacks. The feedline was a 300 ohm *Amphenol* cable with the lead just long enough to reach the transmitters at the foot of the masts. All material carried by the climbing party was duplicated in case of failure. Total weight was 130 pounds.

The receiving antenna was a three-element, close-spaced rotary beam. This unit was tied to the chimney of the Hotel Beau-Site in Zermatt, where a temporary studio and recording center had been set up in the hotel tower. The tower commanded a clear view over the entire route followed by the party from the base of its climb—the Hornli Hut at 9500 feet.

With nearly a week to go before the scheduled Sunday broadcasts, we felt confident. Then a small, thin cloud—dangerous in this region—appeared in the sky and for the next four days we sat through showers. Snow, turning to treacherous ice, fell at as low an altitude as 6000 feet. Thursday, the day set for the trials under actual climbing conditions, was so bad the party could get no farther than the Hornli Hut.

Finally, on Saturday the weather cleared and with the promise of 48 hours of clear weather the ascent began. From point-to-point, the climbers gave us a detailed description, direct from the sheer slopes of the Matterhorn while they were tied uncomfortably on fixed ropes to the sheer 200 foot wall not far from the summit. All of the transmissions were clear as a bell—except from one of the huts when the other alpinists passing along the narrow ledge interrupted the field of the antenna.

The Swiss National Anthem, played on a harmonica by one of the guides, from the 15,000 foot top of Matterhorn fulfilled and climaxed a long-dreamed of achievement for *Swiss Broadcasting Corporation*. Today, used-up batteries remain on the peak as souvenirs of a climb unique in alpinism and radio broadcasting.

—30—

Use my 19 years of Radio Experience To Double Your Earning Cut Servicing Time in 1/2



Lectures by
M. N. Beitman,
engineer, author
& serviceman.

**30 LECTURES
COMPLETE \$3.00
ONLY**

SUPREME NEW AMAZING OFFER

Add years of valuable experience to your radio knowledge by using ideas and tricks of an expert. Use this new 3-in-1 giant-size 30-lecture manual to polish up your radio servicing ability, so that toughest jobs will be as easy as replacing a filter condenser. Learn the cause of every puzzling radio defect. Use Beitman's 19 years of successful radio experience to your own advantage.

A \$60 VALUE, YOURS FOR ONLY \$3

Think what it would cost to attend in person the 30 lectures completely printed in **ADVANCED RADIO SERVICING** manual. Perhaps \$60, plus carfare. But in this mammoth volume you have every word of all lectures, illustrations of every slide used, and many additional photographs and charts. The special bargain price for the complete 30-lectures in the giant manual is only \$3, postpaid, full price, nothing else to pay. Send coupon at bottom of page to try this material for 10 days without risk under our guarantee.

HERE IS WHAT YOU GET

- BOOK 1.** How to operate a radio shop. Right location. Store arrangement. New ideas on getting more business. Plans for model shop. Lecture on how and what to charge. Slides, illustrations.
- BOOK 2.** Twelve practical lectures on using all types of test equipment, such as: simple meters, vacuum tube volt-meters, tube testers, signal generators, oscilloscope, signal tracers, point-to-point technique, condenser testers, bridges, etc.
- BOOK 3.** Fourteen more lectures on radio circuits, trouble-shooting, and servicing. Includes all types of sets—auto, home, portables, F.M., and Television.

GET AHEAD OF OTHERS

By simply reading these 30 lectures and examining the hundreds of interesting illustrations, slides, and diagrams, you add 19 years to your own radio experience. This is real practical knowledge to place you above competition. Facts to help you improve your shop, how to obtain free advertising. Learn what faults are most common to various circuits, how to find these faults quickly, and what instruments to use. Material on every important radio servicing topic including F.M. and TV. See coupon at right. Send coupon at bottom of page.

SUPREME RADIO MANUALS

SUPREME TELEVISION MANUALS

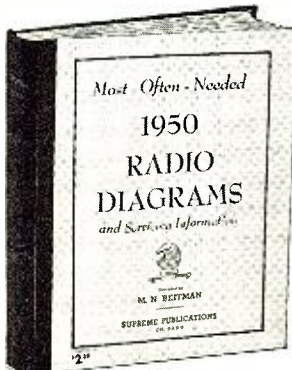

New 1950 Radio Diagrams

Now you can benefit and save money with **Supreme** amazing scoop of 1950. This one giant volume has all the service data you need on all recent radio sets. Here you have clearly-printed large schematics, needed alignment data, parts lists, voltage values, and information on stage gain, location of trimmers, and dial stringing illustrations. This is the help you need to find tough faults in a jiffy. The new 1950 radio manual is a worthy companion to the 9 previous volumes used to an advantage by over 128,000 shrewd radio men.

MOST AMAZING MONEY-SAVING BARGAINS

The television series manuals are the most remarkable values offered by **Supreme Publications** in their 17 years of business. These TV manuals at only \$3 and \$2 each are amazing bargains and defy competition. There is nothing else like them. Each manual is a virtual treatise on practical television repairs. By normal standards, each such large manual packed as it is with practical facts, hundreds of illustrations, diagrams, charts, photographs, and expensive extra-large blueprints, should sell for \$10—but as **SUPREME** special values they are priced at \$3 and \$2 each. Only a publisher who sold over one million TV and radio manuals can offer such bargains based on tremendous volume-sales.

BIGGEST BARGAIN IN SERVICE DATA

You get best values at lowest prices in **Supreme Publications** manuals. For the remarkable bargain price (only \$2 for most volumes) you are assured of having on hand needed diagrams and all other essential repair facts on 4 out of 5 sets you will ever service. Every popular radio of all makes from old-timers to new 1950 sets is covered. Select manuals wanted, see below, and rush coupon.

SUPREME RADIO MANUALS for PREVIOUS YEARS



1949 1948 1947 1946 1942 1941 1940 1939 1926-1938
SUPREME Most-Often-Needed RADIO DIAGRAMS
Each Manual only \$2. (1949 is \$2.50); 192 pages of diagrams, alignment data, voltage values, parts lists, and service hints; large size, 8 1/2" x 11". To order, see coupon → **RADIO DIAGRAMS**
240 Pages
Price \$2.50



New 1950 Television Manual

This newest giant volume of the series covers 1950 factory data on all popular television sets of all makes. There are circuit explanations, 144 pages of alignment procedure, test patterns, response curves, pages of waveforms, voltage charts, service hints, and ten mammoth 11x15" blueprints. Manual-style. Available at your jobber or postpaid. **\$3**
See coupon below, price only.....

1949 T-V Manual. Similar to the volume listed above. Has 160 extra-large pages, plus 9 double-spread giant blueprints. **\$3**
To order see coupon below, only.....

1948 T-V Manual. Earlier volume has material on all popular TV sets of this period. Large size: 8 1/2" x 11". Remarkable value. **\$3**
Including 8 fold-out blueprints, only.....

1947 F.M. and T-V Manual. Covers popular F.M. and television sets including R.C.A. 630TS. Data on 192 pages. Only **\$2**

NO-RISK TRIAL ORDER COUPON

SUPREME PUBLICATIONS, 3727 W. 13 St., Chicago 23, ILL.

Most-Often-Needed Radio Diagram Manuals

- New 1950 Manual, \$2.50
 1949 Radio Manual, \$2.50

- 1948
 1947
 1946

- 1942
 1941

- 1940
 1939

- 1926-1938 Manual, \$2.50

PRICED AT ONLY \$2 EACH

Send me Advanced Radio Servicing at \$3, and the TV manuals checked below and Radio manuals checked at left. You guarantee satisfaction or will refund my money.

- 1950 Television Manual, \$3. 1949 TV, \$3.
 1948 TV, \$3. 1947 TV & F.M., only \$2.

- I am enclosing \$..... Send postpaid.
 Send C.O.D. I am enclosing \$... deposit.

Name:

Address:

Supreme Publications

Sold by All Leading Radio Jobbers

November, 1950



Olson Radio Warehouse, Inc.
73 E. Mill St. • Akron 8, Ohio

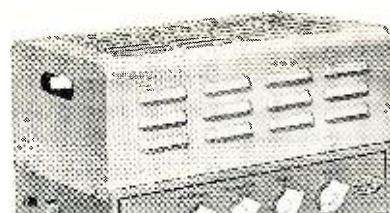

PRICE SLASHED ON LATEST 5-Tube, 12-Watt Amplifier

Inputs for Crystal Mike, Variable Reluctance and Crystal Pickup. Olson's Great Bargain.

It's unbelievable, but Olson has done it again. A full 12 watt beautifully built 5 tube amplifier which has inputs for crystal microphone, variable reluctance phono pickup and crystal phono pickup. In addition this amplifier is equipped with dual tone controls for treble and bass boost, equalized circuits and hum-free wide range response. Engineered by one of the foremost sound experts in the country and licensed by Western Electric. Guaranteed to satisfy.

\$29.95
RA-38

Power output—12 watts. Peak output—17 watts. Frequency response $\pm 2\text{DB}$, 40 to 15,000 CPS. Input—switch provides choice of conventional crystal pickup or G.E. Variable Reluctance. Also any crystal, dynamic or ribbon mike. Also an automatic tuner. Controls—1 phono or Radio tuner; 1 Mike; 2 bass and treble tone controls. Tubes—2—6SL7gt, 2—6V6gt, 1—5Y3gt. Output impedances—4 and 8 ohms. Voltage—105-125 volts AC, 60 cy. Complete with tubes

FREE—SEND FOR OUR LATEST RADIO AND TELEVISION BARGAIN CATALOG



30 WATT AMPLIFIER
• Factory Built
• Latest Design
Olson's Price, less tubes, **\$34.95**
RA-23

A real commercial amplifier which looks good and performs well. Not a kit. Gain, mike, 130DB, phono 80DB. Has dual tone controls, one for bass and the other for treble tone. Output impedances 4, 8, 15 and 300 ohms. Input for two mikes and one crystal pickup. Shpg. wt. 20 lbs. Tubes required, 3—6SQ7, 1—6SC7, 2—6L6g, 1—5V4g.



NEW DESIGN
World's Fastest Automatic Changer for RCA 45 R.P.M. Records
RA-45 **\$8.95**

Price Slashed by OLSON Each Developed by RCA. Plays one hour and 40 minutes with one turnover of the discs. No posts, clamps, to harm records. Discs slide easily down large spindle. Crystal cartridge has flat response from 50-10,000 cycles. Needle pressure is only 6 grams. Has built-in precious tipped 1 mil needle. Size 10 1/2 x 7 1/8", height overall, .694" requires 3 1/2" above and 3 1/2" below base plate. 103-125 volts AC. Shpg. wt. 8 lbs. Factory sealed cartons. **SPECIAL AT OLSON'S.**



AM-FM RADIO CHASSIS

Olson Bargain of the Year
Stock No. RA-52 **\$49.95**
with tubes, only

It's new! Never offered before by any jobber! A high quality, high-fidelity radio that will be proud to own. You'd expect to pay more but Olson made a remarkable deal with the manufacturer. When present stock gone, there will be no more. This receiver can be used in combinations selling from \$49.00 to \$50.00. It's a perfect unit for custom building into cabinets, shelves, etc. This amazing set is equipped to receive standard broadcasts from 540 to 1650 KC and FM reception from 87.5 to 108.5 mc. Two dual controls are provided for simplicity of operation. Phone connection on rear of chassis. Wide vision, easy to read dial. This radio cannot be beat for quality and precision. Any FM speaker can be used with this set. Choose one from this flyer. Set is supplied with 8 tubes; 1—2AT7, 1—6BE6, 2—6BA6, 1—6AL5, 1—6AV6, 1—6V6GT, 1—5Y3GT, less speaker. Individually packed in factory sealed cartons. Chassis size 13 1/2" x 7" x 1 1/16" x 8 3/4".



Insulated Resistor Kit

Contains a carefully selected assortment of 100 Insulated resistors. Standard KYA color code. Included are 70—1/2 watt, 20—1 watt and 10—2 watt resistors. Handsomely packed in a durable plastic bag. Regular 1st price \$15.80. Shpg. wt. 1 lb.

\$3.99
AS-32



MICA COND. KIT

Contains an assortment of 10 Mica condensers. Priced at less than jobbers' cost. Shpg. wt. 1 lb. **SPECIAL AT OLSON'S.**



BY-PASS COND. KIT

Assortment of 50 popular values. 200 to 1700 volts, capacities from .0002 to .25 mfd. Quantity limited. Stock up now at this terrific bargain price. Shpg. wt. 2 lbs. **OLSON'S BARGAIN.**



FP COND. KIT

Assortment of 15 popular FP condensers, double and triple sections. Capacities from 10 mfd to 30 mfd; from 25 to 450 volts. Shpg. wt. 3 lbs.



MATCHED PAIR AM-FM CONDENSERS

Beautifully built! 3-gang. Build a tuner or AM-FM set. AM sections are 365 MMFD; FM is 15 MMFD per section. Can be operated by push-button, 100, Shaft 3/16" dia. Condenser 3/2 1 1/2" x 4". Shpg. wt. 3 lbs. **X-201, Only at OLSON'S.**



H & H TOG-22c
Single pole, single throw, 6 amps, 125 V. Regular 60c. Pair **69¢**

KIT OF THREE VARIABLE CONDENSERS

A \$3.50 value. Perfect for the experimenter. Brand new stock. Quantity limited. Get a kit containing 15 assorted variable condensers. Popular Price **\$1.29** values, 2-gang and 3-gang. Some have trimmers, vernier drives, AM and FM styles. **X-226, Carton of 3 ass't.**



ASTATIC MICROPHONE

Universal high output crystal for public address, home recording and communications. Equipped with handle and desk base. 7 ft. shielded cable. A beauty, too, for this price. Shpg. wt. 5 lbs. **M-67, each, \$5.95**



Musical Instrument Mike

Famous quality! Sells for twice our sale price. Easily attached. Delivers brilliant tone from string instruments. With 4 shielded cable and volume control. **M-61, \$6.95**



PANEL LAMPS

Westinghouse, GE, and Tung-Sol bayonet panel lamps, 100 of each type to the box.

Price per 100
X-161 47 **\$5.19**
X-174 44



OLSON KNOB KIT with Steel Cabinet

4 drawers with 12 compartments in each drawer. 6 1/4" x 5 3/4" x 8 1/2". Contains a popular assortment of 50 set-screw and push-on type knobs. You'll wonder how we can offer them at such a ridiculously low price.

AS-26 **\$3.99**
Olson's Price



WHIZ WIRE STRIPPER

Strips off insulation clean and fast. Takes wire up to 1/4" diameter. Has 4 hole blade. Automatic grip releases after stripping. No tool box complete without this handy tool. **TL-1, \$2.95**



FAIRCHILD GRINDER

TL-3 **\$9.95**
each

Every service shop needs one of these handy tools made by the world's famous manufacturer of precision electric grinders. Regular nationally advertised price is \$19.75. The set consists of 1-1/2 volt high speed, air coated grinder, 6 assorted grinding wheels, 1 circular saw blade, 1 hardened steel reamer, 1 buffing brush, 1 abrasion stone and a natural finish wood case size 10"x5"x3" to house the grinder and all the tools. Shipped in original factory sealed cartons.

NOTICE TO MANUFACTURERS OF RADIO AND ELECTRONIC EQUIPMENT

● Olson Radio has established a tremendous market among radio servicemen, amateurs, universities and industrials all over America as well as principal foreign countries. Our famous rapid mailing service is the talk of the trade.

If you have any good, clean surplus radio material which you wish to dispose of, contact Olson at once. We can use: radios, amplifiers, condensers, chassis, phono motors, pickup arms, volume controls, test equipment, speakers, in fact any radio or electronic part or piece of equipment.

Here is your opportunity to turn idle inventory into cash. Write, wire or call Olson, the popular name in radio.

Famous Olson Trumpets and Drivers
Completely all weather. Made by Famous Manufacturer. 10 Watt Paging Speaker. An outdoor or indoor all weather paging speaker. Capable of continuous 10 watt operation. You get the complete unit consisting of an Alnico 5 driver unit (8 ohms) and a spun metal exponential horn with swivel bracket. Bell diameter is 7". Regular list price \$25.00. Packed in original factory sealed cartons. Shpg. wt. 4 lbs. **S-150, Special each, \$11.95**

Trumpet and 25 Watt Driver Unit
All Weather Trumpet: 19" diameter bell, equivalent to a 3 1/2" exponential trumpet. Made of aluminum castings and spinings. Can be used with driver listed here or any other standard driver. Factory sealed cartons. Shpg. wt. 15 lbs. Regular list price \$29.00. **S-152, special each, \$13.50**

The most popular combination on the market. This driver and trumpet is perfect for outdoor (all weather) use on sound trucks, churches, parks, etc. Fully guaranteed by Olson and the famous manufacturer. Driver Unit: 25 watts, 15 ohms for use with trumpet offered here or will fit any standard trumpet. Order from Olson with confidence. Factory sealed cartons. Shpg. wt. 6 lbs. Regular list price \$25.00. **Stock No. S-151, special, each, \$12.50**

SPECIAL COMBINATION OFFER
Olson will supply you with a 25 watt Driver Unit S-151 and an all weather trumpet S-152 at the special price of both for **\$23.95**

OLSON'S GIGANTIC NEW AKRAD KIT—WITH 4-DRAWER STEEL CABINET FREE

Reg. List Price \$18.38. **\$6.95**

AS-36. Olson's Price

We have a limited quantity of Olson Akrad "Super Sealed" by-pass condensers available in 4 drawer steel cabinets, size 6 1/2" x 10 1/2". Drawers have compartments. Condensers are designed to give long dependable service even in the tropics.

Kit Contains 42 Condensers
You get the 4 drawer steel cabinet and the following 42 Olson Akrad "Super Sealed" By-pass condensers.

Qty.	Cap.	Volts	Qty.	Cap.	Volts
3	.001	60	10	.1	600
3	.002	600	10	.003	1800
3	.005	600	2	.005	1800
3	.01	600	2	.005	1800
3	.02	600	2	.01	1800

GE RECORDER AND PLAYBACK

Stock No. RA-53, complete with 4 drawers, tubes and 2 discs. **\$17.95**

A real recorder for children. Discs can be erased and used over. Made by GE and known as the "Play-talk." Records and plays back instantaneously. Each disc plays 2 minutes. Equipped with automatic disc recorder and playback head, 2 tube amplifier, phono motor, combination microphone and speaker, and erasing device. Factory sealed cartons. Underwriters Lab. approved. Shpg. wt. 15 lbs. Regular Price \$39.95. Note: This is a fine item for children and will satisfy them. It is not a high-fidelity recorder intended for commercial use.

JENSEN PM SPEAKERS
Olson's Big Bargain Value

Genuine Jensen PM speakers for PA or radio use. Cone and coil assembly permanently aligned. Heavy Alnico V magnets. Order Early.

Stock No. S-12, 12 Watts, 12" Dia. Shpg. Wt. 7 lbs. **\$7.95**
Net.

2-TUBE PHONO OSCILLATOR KIT

Connect to any phonograph and it will transmit to any radio in the house without wires. Full instructions, all parts and tubes included. Shpg. wt. 3 lbs.

RA-46 Oscillator Kit, **\$3.29**
each.
RA-47, Assembled, **\$4.29**

TV BOOSTER 9.95
KIT Complete

Build your own TV-FM booster. Improves reception in low-signal, "fringe" areas. 3 to 5 db gain in signal to noise ratio. All channel tuning. Complete with 6AK5 tube, pre-aligned coils, etc. Shpg. wt. 5 lbs.

CHELSEA'S FAMOUS C-4 CHASSIS NOW BETTER-THAN-EVER!

**A Great Buy Before!
A Greater Value Today!**

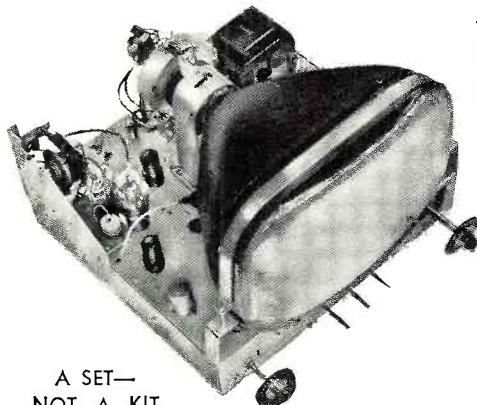

A SET—
NOT A KIT

**Full R M A Guarantee
Free Chelsea 1-Year Warranty**

- Completely wired super power circuit
- Factory-engineered aligned and tested

- Improved AFC
- Keyed AGC
- Front End down to 45 microvolts

- Phono jack & switch
- One-Knob Control
- Greater Sensitivity
- PLUG IT IN—IT WORKS!

NEW GUARANTEED TUBES
16" — round, \$40 16" — rectangular, \$42.50 19" — round, \$60

**CHELSEA'S FAMOUS 630 TYPE CUSTOM CHASSIS
WITH VOLTAGE DOUBLER**

for 16" or 19" **\$149⁹⁵**
less CRT
PLUS \$2.25 Fed. Tax

- Completely wired, factory-engineered, aligned and tested and Guaranteed! Full, up-to-the-minute AFC and AGC improvements, Standard Coil Front End down to 45 microvolts.
- (Specify when ordering whether for round or rectangular tube operation.)

Write Dept. X for latest literature and prices—AND COMPARE!

Phone and mail orders filled on receipt of certified check or Money Order for \$25.00 as deposit. Balance C.O.D., F.O.B., N. Y. Visit our street-level salesroom at 187 Seventh Ave., at 21st St., New York

The House of Bargains

CHELSEA TELEVISION CENTER, INC.

Office and Showroom: 130 West 42nd Street, near Broadway
New York 18, N. Y. LOnacre 5-2254-5-6

Prices and Models subject to change without notice.

The FINEST Amplifiers Require The FINEST Transformers

Acrosound ★

**OUTPUT TRANSFORMERS★
Provide the FINEST quality sound**

- Widest Frequency Response
- Unexcelled Transient Response
- Lowest Intermodulation and Harmonic Distortion
- Professional Quality at a Practical Price
- Highest Power Capacity

Write for FREE descriptive literature, performance data, and suggested amplifier circuits for high fidelity applications.

ACRO PRODUCTS CO., 215 Arch St., Philadelphia 6, Pennsylvania

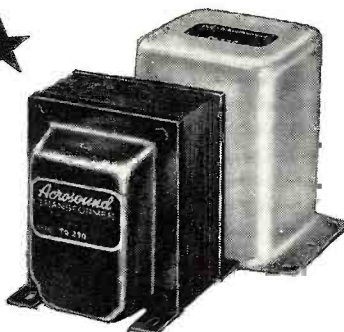

* Pat. Pending

Electronic Compressor (Continued from page 64)

sion at all frequencies from 200 to 10,000 cycles.

Only one adjustment is necessary after the construction is completed, that of R_s . With a v.t.v.m. or oscilloscope connected at some point in the circuit beyond the limiter, apply an audio signal of about 1500 cycles to the input, and adjust its level to 3 volts at the grid of V_1 . Set R_s to maximum resistance and observe the amplitude of the output. Now increase the input

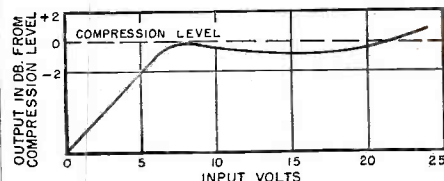
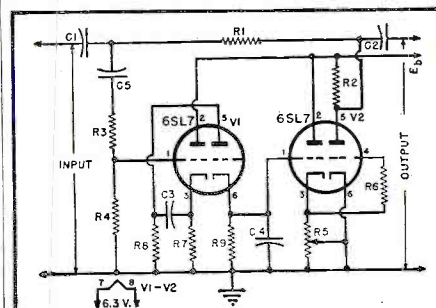

Fig 3. Compression curve.

to about 15 volts to the grid of V_1 and adjust R_s to give the same output amplitude as was noted with the input of 3 volts. Repeat this procedure, leaving R_s untouched at the low input. The unit is now adjusted and should show a compression curve very similar to that given in Fig. 3.

The practical applications of this limiter are wide and varied. This unit has been used commercially in many phases of broadcast work at radio station KAVR. Illustrating its flexibility: The limiter has been used for approximately 6 months in place of the standard commercial limiting amplifier and has been found to be more effective, because of its instant compression. These units have been placed in remote lines and in the network line to assure constant program level to the control board, allowing the control board engineer freedom from "gain riding" on incoming programs. It has also proved itself in recording applications.

Fig. 4. Circuit diagram of deluxe version. Values shown are for a limited range of audio frequencies and for a relatively fast compression, slow expansion time.



R_1, R_2, R_3, R_4 —470,000 ohm, $\frac{1}{2}$ w. res.
 R_5 —25,000 ohm (max.) pot.
 R_6 —15,000 ohm, $\frac{1}{2}$ w. res.
 R_7, R_8 —10,000 ohm, $\frac{1}{2}$ w. res.
 R_9 —1 megohm, $\frac{1}{2}$ w. res.
 C_1, C_2, C_3, C_5 —.01 μ f., 400 v. cond.
 C_4 —10 μ f., 25 v. elec. cond.
 V_1, V_2 —6SL7 tube

Note: Values of R_6 and C_1 can be changed to alter speed of compression.

PHOTOGRAPHY

Annual

268 Pages

WORLD'S
FINEST
PHOTOGRAPHS

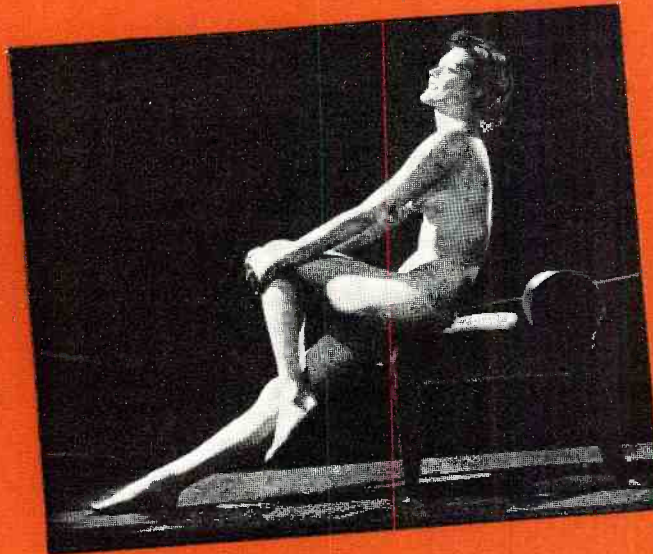

A SELECTION OF THE WORLD'S GREATEST PHOTOGRAPHS *Price \$1.00*
by the Editors of Popular Photography 1951 EDITION

THE OUTSTANDING PHOTOGRAPHIC PUBLICATION OF THE YEAR

268 pages of superb full color and black and white reproductions of the finest photographs of the year as selected by the editors of POPULAR PHOTOGRAPHY. 20 sections—each one devoted to a separate subject: "The Fast Shutter," "The Slow Shutter," "The Large Aperture," "The Small Aperture," "Lenses," "Filters," "Camera Angles" and many more. Each section prefaced with comprehensive, instructive text . . . all photographs analyzed and defined.

PRICE \$1.00!

*Limited Supply
Ideal Christmas Gift*

PRICE \$1.00!

ON SALE AT PHOTO DEALERS AND NEWSSTANDS OCTOBER 20TH

ZIFF-DAVIS Publishing Company

185 N. Wabash Avenue

CHICAGO 1, ILLINOIS

November, 1950

111

new! amazing
2nd edition Howard W. **SAMS**
Radio & TV Industry
RED BOOK

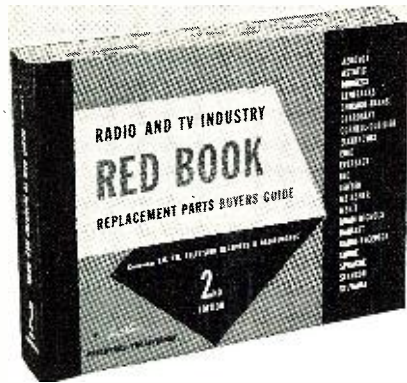

NOW Complete
TV & Radio
Replacement Parts Data—
All Yours in One Volume!

- Covers 22,000 models from 1938-1950**
 - Lists 22 major components—19 parts mfrs. represented**
 - First complete TV parts compilation**
 - Over 600 pages ONLY \$3.95**
- NEW Second Edition of the famous RED BOOK tells you in one volume all you need to know about TV and Radio replacement parts for approximately 22,000 sets made from 1938 through 1950! Includes complete, accurate listings of ALL 22 major components. Provides proper replacement listings for 22 product lines produced by 19 leading parts manufacturers. Gives original parts numbers, proper replacement numbers and valuable installation and service notes on TV and Radio Parts: Tubes, Capacitors, Transformers, Controls, IF's, Speakers, Vibrators, Phono-Cartridges, Batteries—plus the first complete TV parts compilation, including replacement parts data for sweep oscillator and horizontal and vertical output systems. Over 600 pages, 8½x11", sewed binding. You can't afford to be without the RED BOOK—pays for itself with just a few days' use. Order your copy today!

SAVE 95c! If you own the First Edition RED BOOK, tear out the first page, present it to your distributor, and receive 95c credit or allowance on purchase of Second Edition.

Order from your Parts Jobber today, or write direct to **HOWARD W. SAMS & CO., INC.**, 2201 East 46th St., Indianapolis 5, Ind.

ORDER TODAY!

My (check) (money order) for \$..... enclosed.

Send.....RED BOOK (S). \$3.95 per copy.

Page 1 from First Edition RED BOOK is enclosed for 95c credit.

Name.....

Address.....

City.....State.....

For ham use, its assets are readily apparent. It does away with one of the greatest bug-a-boos of the radio amateur, overmodulation, at practically no additional cost.

Circuits of this type should find wide usage where space or cost considerations have heretofore prevented the use of a compressor. Because this circuit has no amplification, it is necessary to amplify the output before incorporating it in a previously designed amplifier, but one triode stage is usually sufficient. Thus it is possible to have effective volume compression over a range of up to 20 db. change in input with only three triodes, and if a twin-triode (such as a 6SL7GT) is used, that means only two tubes. Distortion is negligible and the rate of compression is fast. If even faster compression is desired, the circuit of Fig. 4 (page 110) can be used.

With proper design almost instantaneous compression can be accomplished. Other circuit factors than those shown in Fig. 2 (page 64) affect parts values and those shown are for average use.

-30-

The "Auditioner"
(Continued from page 51)

ized preamplifiers, with an output connection from the preamplifier section to permit connecting to the phono input of tuners in a complete system with radio. Two rows of switches are assigned to amplifiers, one for the input of the built-in preamplifiers and speaker output, and one for the high-level input and speaker output. Each amplifier, then, has two buttons assigned to it. With buttons in the "up" position, the inputs and outputs of each of the components connected are shorted. Depressing a button opens the shorts and cuts the unit into the line. Since the photographs were taken, another row of speaker buttons has been installed to provide for switching up to 25 speakers. Also included is a speaker "T" pad for adjusting levels to speakers at the control panel. This pad is also effective for demonstrating relative speaker efficiencies.

Contacts are provided at each push-button switch position for controlling lights in the center panel. 6.3 volts a.c. is used. The console itself is of all-steel construction. It is finished over-all with *Meyercord* decal in the bleached mahogany crotch pattern, very closely simulating natural wood. It measures 58" long, 43" high, and 33" deep.

Demonstrations with the "Hi-Fi Auditor" have been most effective. While it would take a lifetime to listen to every one of the 371,293 possible combinations, the quick selection of combinations in which any one person may be interested, has resulted in faster and better service to *Allied's* customers.

-30-

cult to construct equipment which is as precise and uniform in response as required for accurate registration. It is even more difficult to maintain the precision as time goes along, for the electrical component parts age." The *CBS* system, however, was praised for, according to the report, . . . "it is not troubled by other than minor registration problems at the camera or receiver. These minor problems arise from power supply hum, stray fields, and vibration, but they are easily cured. . . . Color breakup and color fringing were observed at the demonstrations on the disc receivers. The use of long persistence phosphors should minimize the color breakup at the receiver. Color fringing, moreover, will still occur due to the use of the color disc at the camera." *RCA* did not fare too well in its tests of registration, according to the FCC, who stated that . . . "registration, both electrical and optical, is a severe problem at the camera and receiver. At the camera this is due to the fact that three separate pickup tubes are utilized." At a demonstration of a receiver employing a single tri-color tube, FCC also noted that . . . "there was evidence of faulty registration." However the comment was modified by the statement that . . . "such registration may have been the fault of the camera rather than a receiver, since a misregistered picture results if there is misregistration in either the optical or electrical aspects of the camera or receiver. . . . *RCA* did testify that a single tri-color tube could be developed for the camera which would have correct registration built into it. No such tube was demonstrated or was there any testimony that one had been constructed." And then the government reps said quite sharply . . . "It is difficult for the Commission to see how the *RCA* system could utilize such a tube even if one were constructed. . . . The principle of mixed highs upon which *RCA* relies so heavily requires, by its very nature, a simultaneous camera pickup of three color signals."

ANALYZING COLOR FIDELITY, the report disclosed that at all of the demonstrations on record . . . "*CTI* had difficulty with color fidelity because of faulty registration." *CBS* won a point in this test, too, for according to the FCC . . . "the color fidelity of the *CBS* system, as demonstrated on the disc receiver, has been of uniformly high quality." *RCA* failed on this score, said the Commission, for at the demonstrations, they . . . had difficulty producing a color picture with adequate color fidelity." The comment was amended, however, by a statement covering a special demonstration, during which the color fidelity of *RCA* pictures was found to be adequate.

NIAGARA!—ONE OF AMERICA'S GREAT ELECTRONICS STORES

TO OUR TUBE BUYING PATRONS

Many popular receiving and T.V. tube types have become extremely difficult to obtain. As some numbers reappear, others become scarce. Daily price fluctuations prevent us from preparing our usual monthly tube listing (submitted to RADIO NEWS two months before you see it) with any degree of accuracy.

We still claim to have one of the largest stocks of tubes in the country and probably can supply most if not all of our customers, however, all tube orders will be accepted "first come first served" and dependent upon current prices and availability.

Quotations will remain valid for no more than 48 hours (two days) and are subject to change thereafter. Don't waste time—it can mean money! Write, phone or wire your tube order today!

SPECIAL SCOOP ARC 5/R—28 2 METER RECEIVER

HOTTEST 2 METER RECEIVER available today. 4 channel XTAL controlled with relays, easily converted. Covers 100—156 MCS. Supplied with all tubes. 4—717A, 1—12A6, 3—12SH7, and 2—12SL7 gt. Originally \$65.00. Brand new—original cartons.....

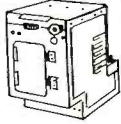

\$19.95

WOW!

HEART OF THE BC-221 FREQ. METER

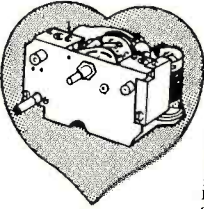

This VFO Sub-Assembly, used in BC-221 Freq. Meter, is ideally suited for home construction of:

- 1—Amateur V.F.O.
- 2—Freq. Mtr. Foundation
- 3—Portable Transmitter
- 4—Replacement for BC-221

Unit contains two temperature and moisture compensating coils, wafer switch, 3 variable condensers, carbon resistors, and silver mica condensers. FULLY WIRED and mounted on sturdy aluminum sub-chassis, ready for installation. Brand new—in original packing.

New Low Price..... **\$4.95**

BIGGER BARGAINS!

T-17 MIKE

Lowest Price Ever! Slightly used, guaranteed perfect and clean. Single button carbon hand mike. Light, efficient, 200 ohms. Press-to-talk switch. 5-ft. rubber cord with PL 68 plug attached.

Used 2 for \$1.00. New \$2.50 each



New Low Price Niagara Famous High Pass Filter



BLEEP
BLOOP
BLAP

Positive protection against interference from amateur transmitters, diathermy, and all other devices generating radio frequency interference below 40 MCS. Designed for 300 ohm leadin. No loss in brightness or clarity. Wired and tested.....

\$2.50

Postpaid if entire amount is included with order.

LOW PASS FILTER

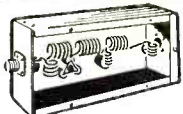

Don't be blamed for TVI! Tests have proven that Niagara's low pass filter attenuates all frequencies above 40 MC. May be used on all bands from 10 to 160 meters. Will easily handle a full Kw. Matches 52-72 ohm line. Plus 25c shipping charges in U. S. A.....

\$4.99

TRANSFORMER BARGAINS!

Plate

750-0-750—300 MA. \$ 7.50
1025-0-1025—500 MA. 17.95
2500 V.—1 MA. 3.95

Filament

2.5V-5A, 7.5V-4A \$2.60
2.5V-10A cased 4.95
5 V.C.T.-3A 1.35
5V-10A 1.85
5 V.C.T.-10.5A 2.15
5 V.C.T.-15A 5.95
6.3V-3A 1.29
6.3 V.C.T.-3.5A 1.49
Three 6.3 V.C.T.-4A each 1.80
6.3 V.C.T.-6A 1.85
6.4V-8A 2.05
7.5V-5A 2.49

Power

40-0-40—250 MA.—5V-3A \$1.25
55-0-55—250 MA.—5 V.C.T.-3A, 5 V.C.T.-3A 1.35
175-0-175—150 MA.—6.3V-6A 2.15
275-0-275—70 MA.—5V-5A, 2.5V-10.5A 3.00
325-0-325—40 MA.—5 V.C.T.-2A, 2.5 V.C.T.-4A 2.25
325-0-325—70 MA.—6.3V-1.2A, 5V-3A 2.95
350-0-350—70 MA.—5V-3A, 6.3V-3A 3.05
350-0-350—100 MA.—6.3V-6A, 6.3V-2A 3.25

Modulation

807 to P.P. 6L6 \$2.49
P.P. 807 to single 6L6, 4D32 (2400 ohms) 3.49
From 200,500 ohms to 5, 6, 7, 8, 9, 10K ohms at 150 MA. 4.49

Driver Xfms.

200, 10,000 ohm P. to single G. \$.79
10,000 ohm P. to single G.89
P.P. 45, 2A3, etc. to P.P. 210, 801, etc. 1.95
P.P. 6L6, 2A3, etc. to P.P. grids. 1.65

Output

P.P. par. 2A3, 45, etc. "AB" to 4, 8, 15, 500 ohms \$1.89
6V6 to 2, 4, 8 ohms69
P.P. par 6N7 Class "B" to 8000 ohms 1.49

Input

600 ohm C.T. to 300 ohm mike. \$1.49

Mike to Line

From and to 50, 125, 200, 330, 500 Ohms \$2.49
30 ohm mike to 600 ohm C.T. Bal. line 1.65

Chokes

.875	HY.	2.5 Amps	\$8.95
2.5	HY.	4 Amps	8.95
2.5	HY.	130 MA.	1.10
4	HY.	40 MA.	.25
8	HY.	200 MA.	2.35
10	HY.	180 MA.	3.49
40	HY.	90 MA.	
10	HY.	200 MA.	2.49
12	HY.	150 MA.	1.75
15	HY.	125 MA.	1.60
15	HY.	200 MA.	2.65
20	HY.	125 MA.	1.75

TINIEST V.O.M. IN THE WORLD

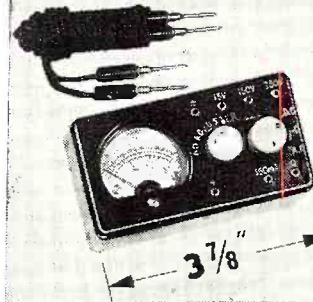

NIAGARA exclusively presents the "Universal Baby Tester" measuring 3 7/8" x 2 1/8" x 1-3/16"! Contains a sensitive 0-240 microammeter with the following ranges:
● 0-15V AC or DC ● 0-750V AC or DC
● 0-150V AC or DC ● 0-150 DC MA.
Ohms adjust and DC-AC-OHMS switch. Includes 1 pair test leads. Will fit into your watch pocket. Fully guaranteed. Special..... **\$8.95**

5 WATT AUDIO AMPLIFIER

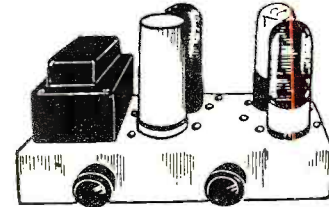

Complete with speaker and 3 tubes. Hi-impedance output for XTAL mike or Phono-Pickup. Volume and tone controls. 5 W. amplif. with 5" speaker **\$8.95**
Same as above with 8" speaker..... **9.95**

MORE LINES!

SPECIAL 1500 Volt—300 MA Power Supply Kit

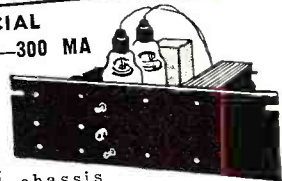

Complete with punched chassis 19 1/2" rack panel, tubes, choke, transformers, hardware etc. **\$24.95**
WHAT A BUY!.....

SALE!

274N and ARC-5 XMTRS and RECEIVERS

2.1-3	MC. Xmrtr.	\$14.95
3-4	MC. Xmrtr.	19.95
4.5-3	MC. Xmrtr.	12.95
5.9-7	MC. Xmrtr.	12.95
7-9.1	MC. Xmrtr.	24.95
190-550	KC. Revr.	14.95
550-2000	KC. Revr.	24.95
3-6	MC. Revr.	7.95
8-9.1	MC. Revr.	7.95
100-156	MC. Revr.	19.95

Niagara Radio Supply Corp.

Dept. N-110

160 Greenwich Street, New York 6, N. Y.

Phone
Dlgy 9-
1132-3.4

**We Have Available
CODE PRACTICE TAPE**

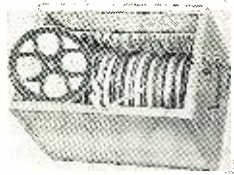

which was used for code practice work by the Signal Corps—from slow to fast practice. 15 rolls on 16MM metal reels in heavy wooden slotted case, to be used with McElroy TG10 Keyers, Tone Keyers or any code practice

unit using printed tape.
Special

\$9.95

TUBES

531 Westinghouse	\$9.95
724A Sylvania	4.95
724B Western Electric	1.50
801A Kenrad39
CK1005 Raytheon19
2C34VT59

NAVY TBY TRANSCEIVER

23 to 80 Megacycles. Frequency equipment. Types of transmission MCW Telegraphy and Telephony power output. .5 watts. Complete with tubes, aerial. Head set, crystal controlled. Microphone. 3 spare tubes and canvas carrying case

\$24.95

TBY Head and Phone sets

\$ 1.95

TS-10 Sound Power handsets.

27.95

Brand New. Each \$15.00. 2 for

Transtat Volt Regulator, 115V., 400 cy, 6 Amp.

1.49

ELECTRIC STORAGE BATTERY

Same description as above, 24V., 11 Amp. hours. Size 8 x 8 x 7 1/2" high. Wgt. 34 lbs.

\$12.95

GOULD STORAGE BATTERIES

Completely covered black hard rubber case, with wing nut terminals on side. 6 x 10 x 10" high; non-spillable, 12V., 34 amp. hours, 5 hour rate; wgt. 40 lbs. when fully charged. New, shipped in original sealed carton. Each

\$9.95

STORAGE BATTERY

Will give you lots of good service. 6 volt-40 amp. hours, in plastic case. Size 7 x 7 x 5". Shipping wgt. 15 lbs. It's new and only.

\$3.95

GIBSON GIRL

The Emergency Radio Transmitter. Sends SOS signals automatically on 500KC. 150-mile range. No batteries required. Has hand-driven generator. Tubes, 300 ft. antenna wire like new.

\$2.95

Or complete with Instruction Manual, Kite, Hydrogen Generator with feed pipe, Antenna Wire, Balloon, Signal Lamp

\$8.95

EVEREADY AIR CELL BATTERY

You certainly know what these Batteries are. All we will say is—1.25 volts; 600 amp. hour capacity. All brand new, in perfect condition. Made by National Carbon Co. Shipping weight 15 lbs. each. They sell for many, many times our price. While they last. Each

\$1.39

METERS

3" Square 0-15 Mill D.C., G.E.	\$3.45
3" Round 0-15 Mill D.C., Westinghouse.	3.45
2" Round 5-0-5 Amp. D.C.59
4" Square 0-200 Microamps. Simpson Basic VTVM movement.	7.95

WATTHOUR METERS

G.E., 1-16 single phase 60 cycle 115-120V. 5 amp.—two wire—glass case.	\$4.95
Westinghouse or Sangamo—metal case—115-120V., 5 Amp. 60 cycle, single phase	\$3.95

PHOTO ELECTRIC CELL (SELENIUM)

Mfd. by Selenium Corp. of America. 500 Microamperes per lumen. Generates 1/2 volt in bright sunlight. Used for photo exposure meters; colorimeters; with sensitive relays, etc. Generates current without batteries. Each

\$1.49

MICRO SWITCHES WZ-S.P. normally closed

\$0.19

MICRO SWITCHES YZ-S.P. normally closed

.19

MICRO SWITCHES BZ-S.P.D.T.

.39

Prompt Delivery—25% deposit required on C.O.D. order. Shipped F.O.B. New York.

Write Dept. RN-11

MICHAEL STAHL, INC.

215 FULTON ST.

WO 4-2882 New York 7, N. Y.

Resolution received an extremely comprehensive study in the report. Reviewing the method used by CTI, the government experts declared that . . . "In theory the resolution of the CTI system should approach that of the present system. This has not been the case, for at none of the demonstrations did CTI produce a picture which could compare in resolution with black and white television. The reason for this lies in the faulty registration . . . and in the line crawl which is present in the system." Detailing the approach used by CBS, the report stated that since this system produces 405 lines as compared with the standard 525, the vertical resolution is below that of the present system. In addition, the use of 144 fields per second, with a resulting line scanning rate of 29,160 per second results in a loss of horizontal resolution, too. A reduction in vertical resolution by 23% and horizontal resolution by 46%, as compared with the current standards, was cited by FCC. The RCA system, which produces lines at the same rate as the black and white system, seemed to suffer in the practical demonstrations, the FCC noted. They felt that this was due to crosstalk and the use of mixed highs, plus misregistration.

The vote on the plan to adopt the so-called *bracket* standards, for 405 and 525 pickup, a 4-2-1 affair, disclosed just how the Commissioners felt about the whole problem. On the majority side of four, asking for the interim standing, were the FCC Chairman, Wayne Coy, and Commissioners Walker, Sterling, and Webster. Favoring immediate adoption of the CBS standards were Commissioners Hyde and Jones. And Madame Commissioner Frieda Hennock asked for a deferral of final judgment until next June.

Citing her views on the problem, Madame Commissioner Hennock said that she could not agree with the premise . . . "that in the event bracket standards are adopted a tentative determination to adopt an incompatible system should be made." In her opinion, such a decision would . . . "be premature." She felt that . . . "there are many indications that intense effort is being exerted to overcome the difficulties inherent in compatible color systems. Off-the-record developments by *Hazeltine, G-E, CTI,* and *RCA* may be bringing us a little closer, if not near, to the realization of a practical compatible system. In any event we should work toward that end with all our energy until the last possible moment, and not foreclose the possibility of its achievement until convinced that it is a practical impossibility."

A STRONG DISSENTING OPINION on the compatibility phase of the bracket plan was also included by Madame Commissioner, who declared that . . . "Incompatibility will . . . pose a serious problem for the broad-

caster, and its effects will very likely be felt by all television viewers. To the extent that there are receivers in the hands of the public which are unable to receive field-sequential color broadcasts, every program broadcast under those standards entails a loss of audience for the broadcaster. Our broadcasting system is dependent for its economic existence upon advertising revenue, and the advertising value of a broadcast varies directly with the number of people which it can reach. The decision to produce a program in color will be a difficult one for the broadcaster to make if it means that the program will thereby become less salable. The transition to color, must, when viewed in this light, be long and difficult. With compatibility, any program could be produced in color, without loss of audience, and a great impetus would be provided for the purchase of new color receivers."

Praising the possibilities of the new art, Miss Hennock said: "Color television, I feel, is a great forward step, with untold potentialities for the improvement of television for education and industry, as well as entertainment. But it has been decided by this Commission that the most desirable course to follow would be to allow more time for the development of all color systems, including the CBS field-sequential system. In view of this fact, and the fact that the problems posed by incompatibility will be frozen at their present level, I feel that every encouragement should be given the development of a compatible color system. It would be improvident, in my view, to allow only as little as three months for such a significant and difficult development to take place. I therefore feel that the date of final decision in this matter should be postponed until June 30, 1951."

IN A CONTRARY VIEW, Commissioner Rosel Hyde declared that he was of the . . . "opinion that such dislocation and inconvenience as will necessarily be caused by the introduction of a color system, would be minimized by definitive action now. Such dislocation and inconvenience would be magnified by the absence of final action during the period of indecision, the length of which cannot be precisely determined at this time. Purchasers of new sets, who would have had the option of obtaining color sets immediately, if they so desired, will now be forced to elect either to purchase a set which will require conversion to color or to await final action at some future undeterminable date. Manufacturers would have been able to devote their full television research facilities and energies towards the further improvement of one proven and accepted system . . . instead of dissipating them in further attempts to surmount difficulties which may be inherent in non-field sequential systems. . . . Broadcasters would have been able to begin immediate experimentation with color programming



TAPE RECORDER NEWS

from THE BRUSH DEVELOPMENT COMPANY, Cleveland 14, Ohio

NEW SOUNDMIRROR® ARRIVES!

**New Design—
Silent Control—
More Power—
Are Features**

It looks like a fine piece of luggage. It has the quiet operation of a high-priced phonograph. It possesses great power output, self-contained speaker . . . superb playback quality. These are the high lights of the new Soundmirror by Brush.

Long famous for its precision characteristics, the new model is a *third smaller* than any traveling tape recorder previously made by Brush. Further refinements . . . microphone storage compartment; a readily-accessible telephone jack for input hookup from radio, phonograph or other source, and output for playback through any speaker; a removable cover with lock-type hinge.



NEWEST AND FINEST of magnetic tape recorders is this new Soundmirror by Brush. The case in beautiful two-tone tan looks like fine luggage and is perfectly balanced for easy carrying. A reel of "Magic Ribbon" plastic tape (30 or 60 minutes) is supplied without additional charge with each new machine. BK-443-P will record for 30 minutes. BK-443-PS, similar to it in every other way, takes recordings up to an hour. Priced at \$279.50 (30 minutes), \$289.50 (60 minutes), complete.

Leaders in Tape Recording Bring New Standards to Amateur Field

The trade will call the new portable Soundmirror the most useful magnetic recorder ever to be introduced. It is not "technical" electrical equipment, like recorders in the \$500 to \$1,500 class, nor a "toy"; it combines popular price, high flexibility of use and faithful recording in a mechanism any amateur can learn to operate in five minutes.

Yet all through, to the very tape itself (on a rigid metal reel), to its RCA high quality accordion cone speaker and the Soundmirror's high output, it is built to the finest precision standards.

Five new Brush models, including the Educational Soundmirror, include the same advanced features at practical prices ranging from \$199.50 to \$289.50.

NEW "Magic Ribbon"* for All Recorders

The new "Magic Ribbon", magnetic recording tape (plastic or paper base) by The Brush Development Company, wound on a rigid metal reel to assure professional standards, can be used with all makes of tape recorders employing quarter-inch tape.

Brush tape is packaged in the library album hinged box which makes indexing and storing as easy as putting a book on a shelf.

*Trade-Mark

Latest Brush Achievement Praised by Many Experts

Brush has always made magnetic recorders to professional standards, no matter how popularly priced an individual model might be. The new models just announced are no exception. "Previewed" and "preheard" by such professionals as radio people, musicians and engineers, the new recorder was highly praised.

Many professional people use the portable Soundmirror for street interviews, local recording and other purposes.

The Soundmirror produces such high fidelity and successful results because of such professional features as the eye record volume indicator, the provision for setting volume record level in advance of recording, full precaution against unwanted erasure, and the automatic silent brake stop switch at the end of playback or record.

This is why the Soundmirror is known as "the professional tape recorder amateurs find easy to use".

COUPON..

THE BRUSH DEVELOPMENT COMPANY, Dept. R-11
3405 Perkins Avenue, Cleveland 14, Ohio

Please send me information about the new
SOUNDMIRROR models and the Brush
dealer franchise.

Firm Name _____

My Name _____

Address _____

City _____ Zone _____ State _____

FOR MORE THAN 10 YEARS LEADERS IN MAGNETIC RECORDING

techniques, assured of a progressively growing audience during the period of transition. . . . I hope that the fears expressed by the majority and me will not be realized, and that industry will cooperate with the Commission in reaching the goal by not requesting unnecessary or unwarranted delays."

In the third separate opinion, bitterly dissenting with the majority's action in leaving the door open for future discussion of other possible systems, Commissioner Jones declared that the fundamental disagreement between the other Commissioners and himself was that he was for color now. Elaborating on this point acidly, he said: "Whatever the protestations

or words of the majority, their action on this day is most certainly *against* color now." Continuing his criticism of the other Commissioners' decision, Jones said: "Two systems, RCA's and CTV's, claimed at the beginning of the hearing to be fully compatible and to render a high standard of performance. They failed on both counts throughout 9700 pages of record and in the individual and comparative demonstrations held over an eleven-month period. . . . The third system, CBS's, fully complied with the Commission's public notice of May, 1949. . . . CBS successfully demonstrated on the same record and in the individual and comparative demonstrations during the same period that it

was adaptable, and that satisfactory black and white pictures could be received from CBS color signals with minor modifications on existing sets at relatively minor costs. . . . In view of the consistent record of the industry thwarting color for ten years, the Commission gambles with the only proponent who has advanced a successful system of color television these ten long years. Although the majority claims that the *status quo* will be maintained by a promise of the industry to build bracket standards into a substantial number of new black and white receivers, color still is not being fostered commercially and only black and white is being fostered. The majority says . . . 'one of the easiest methods of defeating an incompatible system is to keep on devising new compatible systems in the hope that each new one will mean a lengthy hearing so that eventually the mere passage of time overpowers the incompatible systems.' In its attempt to relieve the compatibility problem, during the period of more delay, the majority overlooks the fact that because the percentage of sets capable of receiving CBS color signals in black and white goes up, color is not promoted one iota. . . . We either need more information concerning direct-view triphosphor color tubes, long persistence phosphors, and horizontal interlace, or we do not, irrespective of what the industry position is. But the Commission will finalize CBS color if the majority of the manufacturers refuse to build bracket standards in black and white sets."

As this column goes to press, reports direct from Washington indicate that many of the leading set manufacturers have rejected the FCC's proposal to adopt bracket standards. While they have indicated their willingness to comply with the proposal they point out that it is impossible to meet the 30 day deadline. They claim that it will be impossible to adopt the bracket standards within the next six months.

In view of this, should the FCC stick to its guns it may approve the CBS color system outright. It is not improbable that the FCC may extend the time limit for manufacturers to incorporate the bracket standards. If this is done, the color tussle may enter a new tense phase of demonstrations, explanations, and sharp debates . . . L.W.

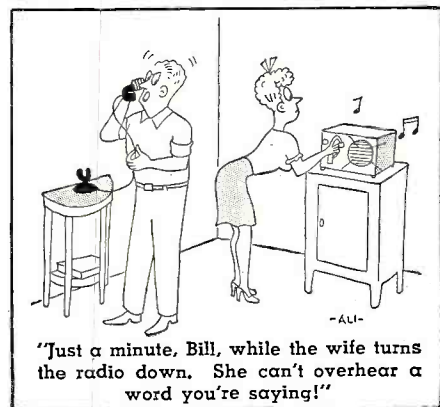

RADIO & TELEVISION NEWS

Beyond Compare—The Antenna that created New Horizons in Television Reception

Telrex
de luxe
CONICAL-V-BEAMS

REGISTERED TRADE MARK

THE FINEST TELEVISION ANTENNA EVER MADE!

Manufactured by Telrex and selected Telrex licensees under Pat. No. 2518297

The original Conical-V-Beam that reached beyond the accepted limits of usable reception and produced satisfactory pictures in areas where reception was considered impossible. For maximum TV profits install the antenna that increases your selling area by producing excellent pictures where others fail. Telrex De Luxe is your one best bet for every TV installation near or far. It outperforms, outsells any other antenna at any price! For complete information, contact your local Telrex distributor or write direct for details and new catalog.

NEW! DOWELLED DURAL ELEMENTS ADD STRENGTH AND DAMPEN VIBRATION — EXTRA-HEAVY DUTY CONSTRUCTION THROUGHOUT

For best reception, insist on the genuine! Look for the Telrex trademark. It's your assurance of reliable factory ratings and long lasting, weather-durable construction.

Telrex INC.
CONICAL-V-BEAMS ASBURY PARK 7. N. J.

AMERICA'S STANDARD OF COMPARISON

THE SKILL TO DESIGN
THE FACILITIES TO PRODUCE
THE ABILITY TO DELIVER

TAB

THAT'S A BUY

PRECISION RESISTORS—

Over 2 1/2 Million in Stock

"TAB"—Specialists in Precision Resistors

0.116	271	1200	3100	14550	91000
0.42	275	1225	3163	14600	93300
0.425	280	1250	3259	15000	95000
0.607	286	1290	3290	16000	100000
0.7	289	1300	3335	16500	110000
0.7	289	1300	3384	16800	115000
1.03	300	1355	3500	17000	116667
1.3	310	1400	3509	17500	120000
1.75	311.5	1488	3700	17777	125000
2.5	320	1495	3700	18000	130000
3	325	1500	3760	18300	135000
3.83	330	1510	4000	18300	140000
4.35	340	1518	4030	18500	141000
5	350	1600	4200	18800	145000
5.025	360	1640	4220	19000	147000
6.25	366.5	1646	4280	19500	150000
6.5	370	1650	4300	20000	155000
7	375	1670	4314	20441	160000
7.8	380	1680	4440	20500	165000
7.9	389	1710	4444	21000	165750
8	392	1712	4500	21500	167000
10.38	400	1740	4720	22000	169200
11.25	410	1770	4750	22500	175000
12	414.3	1800	4850	22990	180000
13.52	418.8	1818	4885	23000	180600
14.2	425	1820	4900	23150	185000
14.25	426.9	1865	5000	23325	186600
14.5	427	1892	5100	23400	190000
15	440	1894	5210	23500	195000
16	450	1925	5335	24000	200000
17	452	1896	5270	24600	201000
19	460	1897	5300	25000	205000
19.2	470	1898	5500	25200	210000
20	475	1920	5540	25500	216000
22	478	1900	5730	25833	220000
23	480	1910	5770	26000	225000
24	487	1902	5910	26500	230000
25	500	1903	6000	26600	235000
26	520	1904	6100	27000	235500
28	525	1905	6125	27500	238000
30	540	1906	6140	28000	240000
31.5	550	1907	6200	28430	245000
32	575	1908	6300	28500	250000
48	580	1909	6495	29000	265000
49	588	1910	6500	29500	268000
50	600	1911	6840	29990	270000
51.78	612	1912	6940	30500	275000
55	625	1913	7000	31000	294000
56.7	633	1914	7320	31500	300000
60	640	1915	7500	32000	307500
63	641	1916	7700	32000	310000
64	645	1917	7717	32500	314000
74	649	1918	7900	37000	316000
75	650	1919	7930	38140	325000
60	657	1920	8235	38000	330000
81.4	665	1924	8090	39000	330000
88	668	1926	8094	39500	335000
89.8	670	1928	8190	40000	340000
92	671	1980	8500	42000	355000
100	675	2000	8700	43000	375000
101	680	2005	8800	43500	380000
105	681	2080	9000	47000	400000
105.7	684	2095	9100	47000	402000
107	689	2141	9445	48500	420000
120	697	2147	9500	48660	422000
121.2	699	2145	9710	49000	425000
125	700	2150	9800	50000	440000
130	711	2190	9900	50500	458000
135	733	2180	9920	55000	478000
147.4	740	2187	10000	55000	500000
150	750	2200	10100	55000	510000
160	800	2200	10500	58333	521000
165	806	2250	10600	60000	525000
170	850	2300	10600	62000	550000
175	854	2400	10936	62000	550000
179	899	2450	11000	64000	570000
183	900	2500	11200	64000	570000
182.4	910	2485	11500	66600	600000
200	917	2490	11690	66650	620000
209.4	946	2500	12800	68000	650000
216	978	2525	12500	68000	650000
220	1000	2600	12600	70000	660000
220.4	1030	2625	12900	70000	660000
225	1036	2610	13100	73500	700000
230	1059	2700	13500	75000	700000
235	1067	2750	13500	80000	763000
240	1100	2800	14000	80000	800000
245	1110	2860	14000	84000	813000
245.4	1150	2870	14250	85000	850000
250	1158	2900	14500	85000	850000
260	1162	3000	14500	88000	930000
				90000	950000

Any Size Above, Each .35c; Ten for . \$3.29

MEGOhms					
1.1	1.579	2.5	3.9	6.5	9.05
1.2	1.65	2.75	4.23	6.7	9.15
1.25	1.75	2.8	4.25	7	11.55
1.3	1.8	2.855	4.5	7.5	12
1.35	1.9	3	4.5	7.62	13.85
1.39	2.1	3.3	5	7.74	13.85
1.4	2.11	3.5	5.5	8	13.85
1.5	2.2	3.673	6	8.02	
1.57	2.25	3.75	6	8.5	

Any Size Above, Each .70c; Ten for . \$6.49

KTS.....

Silver & Mica Cndrs.....	30	\$2.50
Resistors, 50ohm To 2megs.....	10	2.00
Resistors, 1/2W to 50102Meg, 100 for	3.50	
Vitreous WW Resistors 100 for	3.00	
Sockets, Ass'd 8, 7, 5, 4P.....	25	2.49
Rotary Switches, Ass'd.....	6	6 for
6P Tubes, 1/2, 3/4, 1, 2 for	1.49	
Coil Forms, Th'd, 1/2, 1/4, 1/8, 1/16, 1/32	50	1.00
Iron Core Slugs, Screw.....	50	1.00
Elastic Stop Nuts, Ass'd.....	100	1.00
Lugs; Large Radio/Elec.....	100	1.00
Lugs, Small Radio Type.....	300	1.00
Knobs, Ass'd w/Ass'ts.....	125	1.25
Spaghetini Slicing, Ass'd.....	75ft.	1.00
Ceramic Cndrs, Ass'd.....	15 for	1.00
Fuses, Ass'd 1/2, 3/4, 1, 2 for	1.49	
Grommets, Rubber Ass'd.....	100	1.00
Resistors, 2W Ass'd.....	100 for	6.50

RHEOSTATS

25 Watts—Slotted Shaft	350, 500, 1000, 1500, 3500, 5000 ohms	
50 Watts, 20 ohms, Knob & Plate	25 for 98c	

866A KIT & Transformer

2 Tubes, Sekts. Xfmr 115V/60 eye Inpt; Output 2.5vct/10A/10 Kv Ins. \$5.95
872A KIT: 2 Tubes, Sekts; 12KvXfmr. \$12.95
Diode Probe _____ Tube
Unexcelled for No-Loss UHF Testing. NEW. \$5 for \$1

BLOWERS

Cool That Tube!
40 CFM 28vacdc. \$4.98
70 CFM 115V/400cy 4.49
250 CFM 28vacdc. 9.95
250 CFM & 380V/115V. 11.95
vac Transformer. 11.95
100 CFM 115vacdc. 7.98
180 CFM 115vacdc. 10.98

SNOPPERSCOPE

INFRARED Image Converter Tube, Hi-Sensitivity, Simplified Design. 3" dia. WillemitScreen. Resolution up to 350Lines/in. Data/Tube.
"TAB" SPECIAL. \$4.98; 2 for \$9.49

METER SPECIALS

Best Buy! 5 Ma. DC Tuning Meter, 1/2" dia. 98c
C&D SPECIAL. \$1.98
0-1 Amp DC, 3 1/2" \$3.69
Wtchs. 2.95
0-30 Amp DC, 2 1/2" Shunt/Wtchs 2.98
0-240 Amp DC, 2 1/2" Less Shunt. 4.49
0-240 Amp DC, 2 1/2" w/ Shunt/Wtchs 3.49
0-500 Volts DC, 1000 ohms/V Wcd. 4.98
0-7.5 Volts AC, 3 1/2" Wtchs/B-Ges. 3.95
0-150 Volts AC, 2 1/2" (16/800V) 1.98
0-150 Volts AC, 2 1/2" Wtchs/GE/Simpson 25 to 125 eye. 3.98

RCA UNIV OUTPUT XFMR

10W to 10KC. Matches ANY Line or pKrs w/V.C's 3to4or 150ohms to ANY Load/Tube IMP bet. 50K to 250K Ohms. Over 1000 combinations! Acts as EXC. Band Pass Filter or Freq. Att. Unit. 200V, 250V, 300V, HI's or LOW's. IDEAL. Lazy Q-3 action. Works Phone. Gets ONLY Signal you WANT to work with. \$1.98/ea. \$19.80/100

Hi Gain Dynamic Mike & Xfmr Buy!

Comb. hi-gain Dyn. Mike Xfmr. 150ohms to ANY Load/Tube. IMP bet. 50K to 250K Ohms. Over 1000 combinations! Acts as EXC. Band Pass Filter or Freq. Att. Unit. 200V, 250V, 300V, HI's or LOW's. IDEAL. Lazy Q-3 action. Works Phone. Gets ONLY Signal you WANT to work with. \$1.98/ea. \$19.80/100

HEADSETS

8000 ohms—HS18, 2Rcvrs w/PL54&COT3A, Less Bond. \$1.98
6000 ohms—HS93, 2Rcvrs. Band. Cushion, Plug, Used. Exec. Cond. \$1.98
250 ohms—HS30, 2Rcvrs. Band & Cord. Use HS30 as Sound Pwr Unit 2 for \$2.98

VARIABLE CONDENSERS

A. 150mmf/300V Gap HF MILLER or CARDWELL. \$1.00
B. DUAN 15mmf. ca. 90V Von 3000 Volt. Gap. 79c
C. BUD Dual 75mmf. ca. Section 1000 Volt. GAP. \$1.49
D. JOHNSON 7030 74mmf/300V GAP. \$1.29
E. NEUT ZPT 12MMF. \$98c
D. CARDWELL TK-300US 53 to 312 mmf. Can be made into Split Stator. BRAND NEW. \$12.95
F. HAMMARLUND M7C5S 80mmf LIST \$3.40; ca. 1-369 mmf. 79c; Vernier Drive 1-369 mmf. 3 for \$2.00
MIDGET 3-15MMF Midline 49c; 5 for \$2.00
Piasing Condens. 1000 to 10000 pF. Taps 360 Degree Var. Slitwave Cont. 2.39
2 1/2 Meter Butterfly Cndsr 30 MMF W/RT TANK & Choke 69c; 2 for \$1.00

VIBRAPACKS

6VDC in 425V/110ma Out, Less Vibrator, \$10.95
12VDC Input 190V/85 ma Outpt. \$10.95

DYNAMOTORS

28Vin/540Vout/250ma L.N. \$3.49
28Vin/280Vout/60ma \$1.98
12&24Vin/220V/100ma & 5.95
PE94A. Same Above NEW w/Htrs & Start. \$2.7V 400cy Input; 115V 485KVA Output. 14.95
1/30 HP Motor, 117 234V, 47/63 eye. 5/35 Amps, 260-340 RPM, 1 hp. \$4.25
1/2 LE Shaft 3 lbs. New. \$5.98
1/100 HP Motor, 27.5VDC, 7000RPM Cont. \$2.49
24VDC Motor, 1 1/2" dia. x 1 1/2" lg. Shaft, 1/2 lb. Motor & Switch Ass'y. 24VDC/6A/3000RPM. \$1.98
SILV P Switches. NEW. \$4.98
GE-21J1 Selsyns. VOW/FixEm. No Returns.
GE-21H1 Selsyn—Exc. Cond. 2 for 2.49

POTENTIOMETERS

200 ohms, AB-T, 1/2" SD. 79c
100000 ohms, CT-S. 1.98
200000 ohms, 1/2" shaft. 2.4c
1 megohm, 1 1/2" slit milled 1/2". 2.9c

SUBMINIATURE TUBES

Never Before at These LOW Prices!

2E31 Pocket Radio RF Pentode	1.19
2E32 Pocket Radio RF Pentode	1.19
CK526AX \$1.26 CK526X	1.26
CK533X Pwr Amp Output Pentode	1.29
CK505AX Voltage Amp Pentode	1.29
CK506AX Pwr Amp Output Pentode	1.79
CK509AX	1.26
CK512AX Lo-Microphonic Voltage Amp	1.79
CK522AX Output Pentode (20ma Filter)	1.79
CK525AX Output Pentode	1.29
CK526AX Output Pentode	1.29
CK529AX Shielded Pentode Pwr Amp	1.98
CK529DX Pwr Amplifier Pentode	1.98
CK533AX Pwr Amp Output Pentode	1.39
CK534AX Voltage Amplifier Pentode	89c
CK536AX Pwr Amplifier Pentode	89c
CK537AX Voltage Amplifier Pentode	89c
CK539DX Pwr Amplifier Pentode	98c
CK541DX Pwr Amplifier Pentode	1.98
CK542DX Pwr Amplifier Pentode	84c
CK543DX 98c; CK544DX	84c
CK551AX Diode Pent Det. Amp.	1.59
CK576 UE Rectifier Triode	2.25
CK5678 RF Amp Pentode (Shield)	2.48
CK5697 Electromtr Triode	1.89
CK5702 Submini 6AK5 (UHF Pentode)	1.25
CK5703 UHF Oscillator (800 Mc)	7.49
CK5744 UHF Cont-Osc or AF Amp	2.98
CK5784 Submini 6AS6 (UIF Pentode)	2.48
CK5875 4.98; CK5704	5.79

GERMANIUM CRYSTAL DIODES

Type	Replaces	
CK705	1N34, 1N43, 1N48	\$0.77
CK706	1N60, 1N64	54c
CK707	1N62, 1N63	54c
CK708	1N38	1.49
CK709	1N40	3.98
CK710	1N21B, 1N28, 6-7	1.35

RECTIFIERS

30Vin/26Vout/150ma Selen. 2 units, 2 units, 2 units, connect in CT for Full Wave; 4 units available as Full Wave Bridge. 5c Unit 36c; 2 for 60c; 5 for \$1

100ma Selen. 69c; 200ma Selen. .98c
Sensational BRADLEY Double Bridge, 600mA Current, 150V from 105 to 168c. Inpt to 4.5VAC, Output to 3VDC/15mA. Only \$1.98
Full Wave Bridge Selen for Relay. Inpt 115 to 130 vac; Output 115vdc/40Ma. Ea. 49c; 10 for \$4.49.

Input	Output	Amps Tapped	Each
18V	14V	1.35	\$2.49
36V	14V	1.35	1.49
Full-Wave Bridge Rectifiers			
18V	14V	3.5	\$3.98
18V	14V	6.4	5.25
18V	14V	8	6.98
18V	14V	13	8.95
36V	28V	17.5	11.85
36V	28V	3.5	6.49
36V	28V	5	8.49
36V	28V	0.15	18.49
135V	115V	0.5	18.49

CIRCULAR SLIDE RULE

12" Equiv. 2 1/2" Radius PRINT STAYS ON Rotating Plastic, Multiply, Divide, Logs, Dec 98c
PARALLEL RULES. 6" lg. Mr BRUNING. \$1.39c

NEW TV COMPONENTS

HV Horiz & Def Output Xformer Sim RCA 14T5 15-18" Picture Tubes. \$1.98
Width Control Shim \$1.98
Focus Coil Sim 202D \$1.98
IUT 88662 VBO Xfmr H'Sid. 1.69
TV Valve SPECIAL \$1.49
Focus Coil Magn Kinescops. 2.98
HV Cndsr 500mmf/15KV. .65
HEFERS Cndsr 500mmf/20KV. .81
Ion Trap Magnet RCA 203D1. .39
Ion Trap Perm Magnet type. .49
Output Xfmr Sim RCA 204T2. 2.69
1/2 or 1 1/2" Tube Picture Frame Mask \$2.98
TV TWINER. \$1.98

BASIC PHOTOFLASH KIT

Complete PwrSupply, Condns, Lamp, data 115vac \$29.95
Studio Kit AirC 1169set 115vac \$63.95
1169 AirC FlashPwr Pack. NEW, incl Data. \$36.95
16mm Pan. film GS-16 100 1169
AirC set, Ea. \$10.98

PHOTOFLASH CONDENSERS

15mf/330vac/1800vdc INT. 4.49
25mf/330vac/1800vdc INT. 6.49
16mf/600vac/2800vdc INT. 6.98
"SUNFLASH" SPECIAL! 110 Watt-See Non-Darkening, Shock Mt'd, 100-000 Flashes, Inc/Charge 5801. \$10.98
R4340 Sylvania ElectroFlash. A 330 Solder BRAND NEW. \$36.00
K-40 Air Cntrl Comp. Lamp. \$14.98
Hi-V PFlash Pwr Kit. Ideal 1800V DbrCkt, 115vacInpt; Output 900V

EVERYTHING IN TELEVISION!

—Now at your fingertips, for quick, easy reference...



THE VIDEO HANDBOOK

THE COMPLETE TELEVISION MANUAL

by MORTON G. SCHERAGA, *Television Research Consultant, Allan B. Du Mont Labs.* and JOSEPH J. ROCHE, *Editor, Radio and Television Maintenance.*

Now in one volume—all the essential know-how of television! All the up-to-the-minute information on television is arranged for quick reference—in easy-to-understand language.

The VIDEO HANDBOOK gives you practical answers to all your questions on television. This best-selling TV encyclopedia tells you . . .

How Television Works

How to Plan and Engineer Television
How to Troubleshoot and Repair Television

How to Select and Install a Television Antenna

How to Produce a Television Show, Technical Aspects

How to Build an Operating Television Receiver

How to Select a Television Receiver

The VIDEO HANDBOOK contains thousands of vital facts—covering everything you need to know for working in Television. Every important point discussed is visualized in diagram or photographs (over 860 illustrations).

More than 900 pages . . . handsomely bound in durable Fabrikoid. Only \$5.95

SEND NO MONEY

You must see this book to appreciate it! 20,000 copies now working for practical Television men! Mail coupon for YOUR copy TODAY.

—10-DAY FREE EXAMINATION COUPON—

BOYCE-ROCHE BOOK CO.
Montclair 24, New Jersey

Please send me The VIDEO HANDBOOK for 10-day examination. If I decide to keep it, I will send you \$5.95 plus postage; otherwise I will return the book postpaid. (We pay postage if you send \$5.95 with this coupon; same return privilege.)

Name.....

Address.....

City..... Zone..... State.....

Employed by.....
(This offer applies to U.S. only.)

Within the Industry

(Continued from page 26)

retired from the company on the thirtieth anniversary of his employment.

He joined the Rochester firm in 1920 as head of the company's electrical laboratory. With the advent of radio broadcasting he was appointed engineer-in-charge of the company's acoustical laboratory in 1926. In the expansion of the company's activities, Mr. Olney became director of research in 1937. He is a fellow and charter member of the Acoustical Society of America and served as vice-president of the society in 1948-49.

Mr. Olney expects to continue his professional interests as a consulting acoustical engineer specializing in noise reduction and the acoustical design of buildings.

* * *

ROY M. W. GRAHAM, a rear admiral in the USN (Ret.), has been named special assistant to the manager of the equipment sales division of *Raytheon Manufacturing Company*. He will have offices at 50 Broadway, New York 4, N. Y.



Mr. Graham's duties will be in connection with harbor radar systems to facilitate the movement of ships within and in and out of ports during periods of low visibility.

He was graduated from the U. S. Naval Academy in 1919 and received his MS degree from the Sheffield Scientific School of Yale University in 1926. He retired after 34 years active naval service on July 1, 1950.

* * *

WESTINGHOUSE ELECTRIC CORPORATION has announced plans to build a new television plant at Metuchen, New Jersey. The new facility will allow the company to nearly triple its TV production . . . **W. BERT KNIGHT CO.**, technical service representative in Los Angeles, has moved to 10373 West Pico Boulevard in that city . . .

ACME ELECTRIC CORPORATION has begun construction on a new 25,000 square foot building in Allegany, N. Y. The building will be used for the manufacture and assembly of transformer components . . .

FEDERATED PURCHASER, INCORPORATED has opened a new store in Easton, Pa. at 701 Northampton St. . . . **SIGHTMASTER CORP.** has moved its New York office and showrooms to its new plant at 111 Cedar Street, New Rochelle, New York. . . .

THE SUPERIOR ELECTRIC COMPANY of Bristol, Conn. has opened a Cleveland office to serve the Ohio and western Pennsylvania areas. The new office is located in Room 1118, Fidelity Building, 1940 East 6th Street . . .

THE PYRAMID ELECTRIC CO. of Paterson, New Jersey has purchased the former *Solar* plant at 1445 Hudson Boulevard in North Bergen, New Jer-

AMPERITE

Studio Microphones at P.A. Prices

Ideal for BROADCASTING RECORDING PUBLIC ADDRESS

"The ultimate in microphone quality," says Evan Rushing, sound engineer of the Hotel New Yorker.

• Shout right into the new Amperite Microphone—or stand 2 feet away—reproduction is always perfect.

• Not affected by any climatic conditions.
• Guaranteed to withstand severe "knocking around."

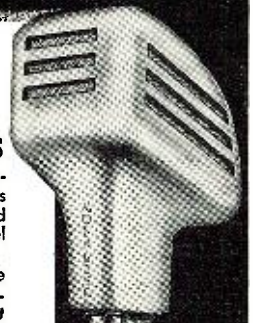

Models
RBLG—200 ohms
RBHG—Hi-imp.
List \$42.00



"Kontak" Mikes
Model SKH, list \$12.00
Model KKH, list \$18.00

Special Offer: Write for Special Introductory Offer, and 4-page illustrated folder.

AMPERITE Company, Inc.

561 BROADWAY • NEW YORK 12, N. Y.

Canada: Atlas Radio Corp., Ltd., 560 King St. W., Toronto

FOR BETTER TOWERS AT LOWER COST! Ask about AERO

• COST LESS

Because Aero Towers are aircraft-designed, lower manufacturing costs offer you a lower price. Lower weight and lower shipping costs are passed on as savings to you.

• LAST LONGER

Coated INSIDE and OUT; DIP-COATED process keeps Aero Towers bright and new. Rust resistant. Will not brown.

• EASY TO CLIMB AND SERVICE

Strong electric aircraft welds at EACH joint (not just one or two) prevents sway. Provides sturdy safe ladder-like cross members.

• QUICKER TO INSTALL

Aircraft precision tolerances assure accurate fit of components. Light and easy to erect. Strong durability assures customer satisfaction.

Jobber Territories Open
Dealers—Write for FREE Booklet



AERO TOWER DIVISION
Knepper Aircraft Service
1016 Linden Street
Allentown, Pa.

sey and is currently in production at the new location . . . **HAYDU BROTHERS** of Plainfield, New Jersey has recently completed additional facilities to handle its greatly expanded production of electron guns.

* * *

ROBERT W. FELBER has been named sales service manager of *Stewart-Warner Electric*, the radio and television division of *Stewart-Warner Corporation* of Chicago.



Mr. Felber, a native of Chicago and a graduate in electrical engineering from Illinois Institute of Technology, started with *Stewart-Warner* as an engineering draftsman in 1945. He was subsequently a field engineer and assistant service manager for the company.

* * *

NEDA'S board of directors, meeting in executive session at Cleveland, named national officers for the ensuing year.

Arthur C. Stallman of Ithaca, New York was elected president of the organization while Dahl W. Mach of Scranton, Pa., was named to the post of first vice-president.

A. W. Greeson, Jr., of Greensboro, N. C., was elected second vice-president, Hoyt C. Crabtree of Dallas was named secretary, and Max I. Epstein of New York City was appointed treasurer of the trade group.

Mr. Stallman, who has been first vice-president for the past two years, succeeds Louis W. Hatry of Hartford, Conn., in the presidency.

* * *

L. E. RECORD has been named division engineer for *General Electric Company's* Cathode Radio Tube Division in Syracuse.



Mr. Record has been associated with the company since 1929 when he was assigned to the vacuum tube engineering department as a test man. In 1930 he was appointed to the engineering staff of the tube division and in 1933 was named section engineer for the cathode-ray tube section. He was appointed supervisor of the engineering development laboratory in 1943 and in 1949 became supervisor of the engineering development and testing laboratories, a position he held until his present appointment.

* * *

PHILIP BARNES has been appointed to the post of general sales manager of *Weston Electrical Instrument Corporation* of Newark, N. J., while **CHARLES B. DENTON** has been named advertising manager of the same firm . . .

CHARLES BEAUMONT is the new district sales manager for *Scott Radio Laboratories* in the Washington, D. C., area . . . *Cannon Electric Development Company* of Los Angeles has named **RAY O. HILL** as controller and **JOHN K. TROTTER** as the new production manager . . . **SIDNEY S. MINAULT** is the new production manager of *Tracerlab, Inc.* . . . *The Muter Company* of Chicago has appointed **ROY W. AUGUSTINE** to its engineering staff . . . **CHARLES SCHRADER** is the director of purchases for *Potter & Brumfield* of Princeton, Indiana . . . **JOHN M. MILLER, JR.** has become the chief engineer of the television and radio research and engineering department of the *Bendix Television and Broadcast Receiver Division* . . . **GEORGE E. HALLETT**, controller of the *Tung-Sol Lamp Works, Inc.*, of Newark, N. J., has been elected president of the Newark Control of the Controllers Institute . . . **WILLIAM THIBAUDEAU** is the new regional sales manager for *Starrett Television Corp.* in the upper New York state, western Pennsylvania, and New England territories . . . The appointment of **JOSEPH KATTAN** as distribution manager has been announced by *Emerson Radio & Phonograph Corporation* . . . **GEORGE M. HAKIM** has joined the *Allen B. Du Mont Laboratories, Inc.*, as assistant advertising manager in charge of cooperative advertising for the receiver sales division.

-30-

here's

absolute reliability

for heavy duty
audio
amplification

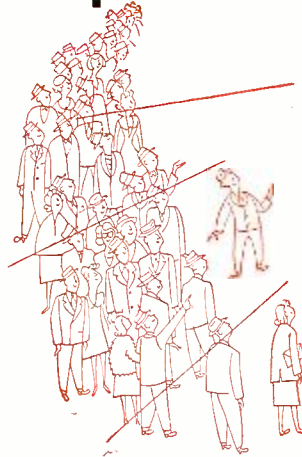

TUNG-SOL



BEAM
POWER
AMPLIFIER

If you've been looking for an audio output tube that's stable under the most severe conditions—completely dependable—then this is it! The Tung-Sol 5881 is rugged both mechanically and electrically—and directly interchangeable with the 6L6.

In creating the 5881, Tung-Sol engineers have made lavish use of the design and production techniques which have proved themselves over the past fifteen years—zirconium coating over the carbonized metal plate and pure barium getter to effectively absorb gas for the life of the tube—gold plated wire to minimize grid emission. These are but a few of the major design improvements in the 5881.

Tung-Sol produces the 5881 under laboratory conditions, to assure peak efficiency and maximum uniformity. You'll find this tube has the stuff to take the whole range of audio service requirements from protracted standby periods to repeated heavy overloads. So, if absolute reliability is essential in your audio circuits, the Tung-Sol 5881 is a "must." Order it from your regular supplier.

Write for characteristics and performance data

TUNG-SOL LAMP WORKS INC., NEWARK 4, N. J.

Sales Offices: Atlanta, Chicago, Dallas, Denver, Detroit, Los Angeles, Newark
Also manufacturers of Receiving Tubes, Miniature Incandescent Lamps,
All-glass Sealed Beam Headlight Lamps and Signal Flashers.

Engineers who "talk test"...
pick **PEERLESS**



The transformer proved definitely superior in the competitive...
SQUARE WAVE TEST

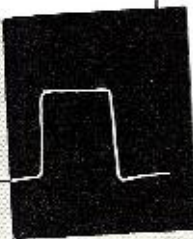

Claims and counterclaims of quality are easy to make... but to the engineer, tests really talk. And indisputable evidence of Peerless Transformer superiority is found in the Square Wave Test... which reveals the slightest flaw in design and performance. Tests conducted by impartial engineers prove Peerless components have better power characteristics, flatter response curves, less intermodulation distortion and lower insertion losses. Send for the complete Peerless Catalog... giving full details on transformers that are really "best by test."

P **PEERLESS** Electrical Products  Division

1161 N. VINE ST., HOLLYWOOD 38, CALIF.
161 SIXTH AVE., NEW YORK 13, NEW YORK



NOW!
SPEED UP ALL SOLDERING WITH
UNGAR
FEATHER-LIGHT SOLDERING PENCILS WITH
HI-HEAT
INCREASED WATTAGE
TIPS



For use with No. 776
Handle & Cord Set.

Stop wrestling with big irons. New HI-HEAT TIPS in your Ungar Electric Soldering Pencil produce a really versatile tool that'll perform on a par with the big, bulky 100-150 watt irons. If you can't get immediate delivery, please be patient, for production hasn't yet caught up with demand. Ask your supplier for No. 1236 Pyramid or No. 1239 Chisel. List price, \$1.25 each.

Ungar
ELECTRIC TOOL CO., Inc.
LOS ANGELES 54, CALIFORNIA

- SPELLMAN
- HAS
- COLOR
- TELEVISION
- PARTS!

WRITE FOR FULL DETAILS

SPELLMAN TELEVISION CO. INC.
3029 WEBSTER AVE., BRONX 67, N.Y.
Kingsbridge 7-0306

Unitary Speaker

(Continued from page 67)

of the moving assembly suspension.

(3). It is possible to design for the desired directional characteristics by choosing the mouth geometry and flare.

The use of the Jensen Hypex formula horn^{1,2} makes it possible to realize better loading near the lower cut-off frequency that can be achieved with the conventional exponential

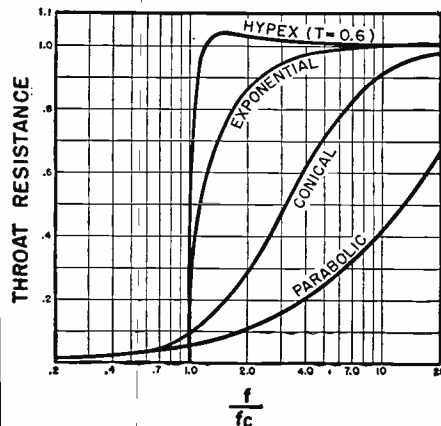

Fig. 2. The effect of throat resistance on the frequency response of various speakers.

horn. The impedance characteristic of an infinite exponential horn is that of a simple high pass constant-k filter shunted by a constant mass. The input resistance deviates from a constant value over too large a portion of the frequency region near cut-off to permit good matching. In the Hypex horns the impedance characteristics are those of m-derived high pass filters, and are analogously adjustable. As can be seen from Fig. 2, the throat resistance characteristic can be made constant to almost cut-off frequency. Therefore, the better low end performance of the Hypex horns allows use of smaller horns than if the conventional exponential formula were used. The smaller horns are correspondingly more suitable for higher frequency use, and thus a gain has been achieved at both ends.

Years of experience with all types of diaphragm material have shown that cloth based phenolic material is most suitable for compression unit driver applications. The excellent damping characteristics, plus high rigidity assure freedom from spurious vibrations and distortion which are typical of metallic diaphragms often used. The high ratio of stiffness to mass in phenolic materials makes possible superior high frequency performance at high efficiency. Whereas metallic diaphragms tend to become fatigued and embrittled after severe and prolonged flexing, phenolic diaphragms retain their desirable physical properties throughout a long service life.

The midchannel unit utilizes a rigid

¹ Electronics, July, 1941.
² Patent 2,338,262.

BELIEVE IT OR NOT! PRICES ARE WAY DOWN



When You Take Advantage of *Surprise* Trade-In Allowances on Used Test or Communication Equipment for one of the **NEW**

RECEIVERS BY hallicrafters

Yes, you save and save plenty with a "Surprise" Allowance on your used (factory-built) Test or Communication equipment. Here's all you do. Simply choose your new Hallicrafters. Tell us what you have to trade. We'll do the rest. So wire, write, phone, or use the handy coupon, today!



Hallicrafters SX-62

But you can buy it for less when you take advantage of a "Surprise" trade-in allowance.

Shpg. wt. 70 lbs. Only **\$26950**



Hallicrafters S-38B

For amazing savings apply our "Surprise" trade-in allowance against this price.

Shpg. wt. 14 lbs. Only **\$4950**

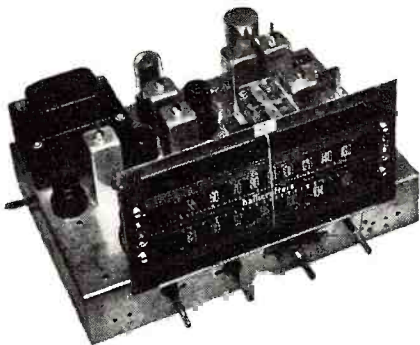

**Hallicrafters FM-AM
Tuner ST-74**

Slash the above price by trading in your used test or communication equipment.
Shpg. wt. 17 lbs. Only

\$5450

**Hallicrafters FM-AM
Chassis S-78**

Buy it at a substantial saving with a "Surprise" trade-in deal. What do you have to trade?

Shpg. wt. 23 lbs. Only **\$7995**

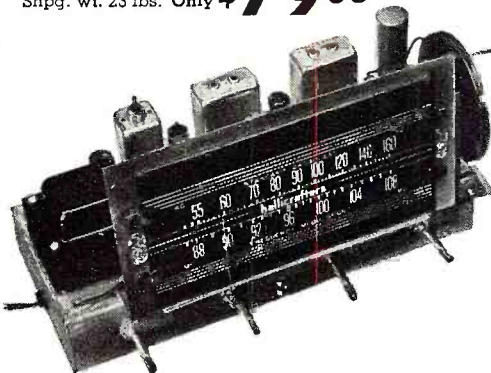

FREE CATALOG!

New 164-page catalog. The "Treasure Chest" of values. Send for your copy today.

All prices f.o.b. St. Louis
Phone CHEstnut 1125

To the Novice . . . On Getting the Right Start
Your entry into the proposed Novice Class of License in Amateur Radio opens up a whole new world of exciting adventure. Hallicrafters Gear provides a practical and economical way to get you off to a flying start. And you'll also start right and stay right when you make Walter Ashe Radio Company your exclusive source of supply for everything in Radio, Electronics, Parts and Supplies.

**Walter Ashe
RADIO CO.**
THE HOUSE OF "SURPRISE" TRADE-INS
1125 PINE ST. • ST. LOUIS 1, MO.

Walter Ashe Radio Co.
1125 Pine St., St. Louis 1, Mo. RN-50-11

O. K. Walter, Rush "Surprise" Trade-in offer on my

(describe used equipment)

for _____
(show make and model No. of new equipment desired)

Rush Free Copy of your new 164 page Catalog.

NAME _____

ADDRESS _____

CITY _____ Zone _____ STATE _____

**SEND
FOR YOUR
COPY
TODAY!**

UNIVERSAL MICROPHONES

"Better Than Ever"

A UNIVERSAL STAR Low-cost, Light-weight LAPEL MIKE

312-Crystal
308-Dynamic

D70
Dynamic

908
Velocity

KD-Crystal
KD-Dynamic

XL-100
Crystal

CU
Carbon

200-TA
Carbon & Dynamic

T-1700
Carbon

AR
Carbon

The new Universal Lapel Microphone is being acclaimed as an example of engineering ingenuity. Weighing approximately 1 oz. with an O. D. of 1 7/8", the Lapel Mike has an amazing sensitivity (-50 d. b.) and ultra-clear speech response. It is moisture protected by special perma-seal construction. The neatly designed, yet inconspicuous, lapel mike has a strong clip for lapel attachment and 25 ft. of extra small diameter, light weight, vinyl cable... and yet... while maintaining the highest quality. THE UNIVERSAL LAPEL Microphone COSTS FAR LESS than any competitive item. Recommended Uses: Dictation, Lecturing, Demonstration, Concealed Pick-Up & also as a Crystal Earphone.

WRITE FOR LATEST CATALOG.

UNIVERSAL Microphone COMPANY

705 IVY STREET • GLENDALE 4, CALIFORNIA

ADSON FOR VALUE!

SERVICEMEN! STUDENTS! HOBBYISTS!
Arkay Radio Kits Are Your Best Buy for Value and Quality!

With Arkay you get top quality parts that assure long trouble-free performance. You get a kit that is designed to equal ready assembled units. Every kit comes with large, schematic, pictorial diagrams and step-by-step instruction manual.

ARKAY

5-Tube Superhet Kit

This streamlined receiver provides crystal-clear reception thru entire tuning range of 550 KC to 1000 KC. 5-tube improved superhet circuit. 115V AC-DC. Full size Alnico V PM speaker. Complete with handsome cabinet and all tubes.



KIT MODEL S-5 \$14.95

ARKAY 2-Band 5-Tube Receiver

High quality 2-band kit to receive domestic AM signals and foreign short wave. Tuning range: 550 KC to 1600 KC. Equipped with high gain coils. Powerful 5" Alnico V PM speaker. Complete with handsome cabinet and all tubes.



KIT MODEL S-5X... \$17.95

ARKAY 6-Tube FM Tuner Kit

Brings in full range of FM stations from 88 MC to 108 MC. 6-tube circuit provides no-drift tuning for steady reception. Equipped with own volume control and all tubes.



KIT MODEL FM-5... \$21.95
Factory Wired \$31.95
And Tested

ARKAY 3-Way Portable Receiver Kit—5 tube radio for portable, battery operation and AC-DC house use. 550 KC to 1600 KC. Smartly designed leatherette case with modern grille and slide rule dial. 5" Alnico V speaker.

KIT MODEL 3W10A... \$18.45

Satisfaction guaranteed. Send check or money order. 25% deposit with C.O.D. All orders shipped within 24 hours, F.O.B. New York. Please include postage.

ADSON RADIO & ELECTRONICS CO.
221 Fulton Street, New York 7, N.Y.

TWIN LEAD, TELEVISION LIGHTNING ARRESTER

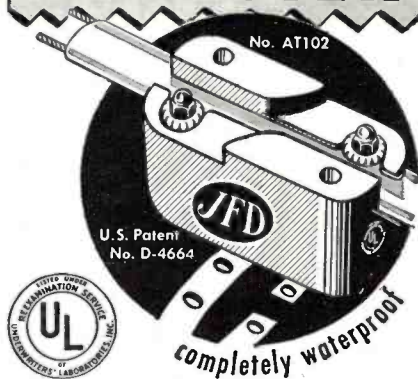

APPROVED for OUTDOOR-INDOOR Use \$2.25
Protects Television Sets Against Lightning and Static Charges

Twin Lead
JFD SAFE TV GUARD

Simple to install everywhere and anywhere...no stripping, cutting or spreading of wires. More than 300,000 in use today!

SEE YOUR JOBBER OR WRITE TO

JFD MANUFACTURING CO., Inc.
6127 16th Avenue, Brooklyn 4, N.Y.
First in Television Antennas & Accessories

re-entrant phenolic diaphragm driven by a two inch voice coil operating in a flux density of 17,500 gauss. Operating efficiency is approximately 50 per-cent. Large clearances avoid non-linear stiffness effects which might arise due to air compression at large excursions in the sound chamber air space. The driver unit operates into a Hypex formula horn, the initial section being formed through the core of the woofer magnetic structure, and the final section being formed by the 15 inch woofer cone. Smooth performance extends down to and below the crossover frequency of 600 cycles, and up to the second crossover frequency of 4000 cycles.

The miniature compression type high frequency unit, mounted in front of the woofer cone, is small enough so that radiation from the midchannel unit is not obstructed. Streamlined surfaces and precise placement for proper phasing afford a smooth crossover transition at 4000 cycles. Its small horn achieves wide dispersion of the acoustic energy by virtue of the small mouth size and Hypex flare. While its dimensions are not sufficiently small to allow this unit to approach the spatially ideal condition of a point source of sound, a suggestion of this condition was observed when the unit was originally placed at the center of the woofer cone. High frequency energy was radiated to the sides and even to the rear of the tweeter unit at sufficient levels to cause reinforcement and cancellation effects due to energy reflections from the woofer cone. Optimum lateral placement of the tweeter in the woofer cone was experimentally determined as the solution to restoring the smooth response as given in free space, while retaining the good spatial distribution of this unit.

While there was no restriction on the type of network to be used for the 600 and 4000 cycle crossovers, a relatively simple 90 degree LC type with

Detailed view showing the arrangement of the three component speaker units.

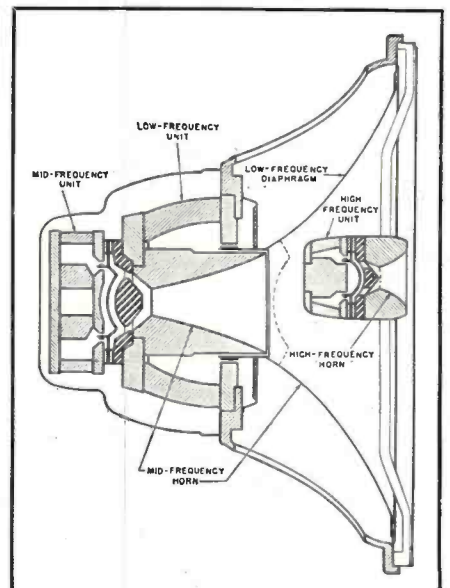

RADIO & TELEVISION NEWS

MAIL ORDER ADDRESS
1060-2 N. ALLEN AVE.
PASADENA 7, CALIF.
SYCAMORE 4-7156
RYAN 1-8271

PHOTOCON SALES

NOVEMBER SPECIALS

RETAIL SALES STORE
1240 EAST COLORADO ST.
PASADENA 1, CALIF.
SYCAMORE 6-7217

Write for Our Latest Sales Bulletins

We will buy new or clean used ARC-1, ARC-3, ART-13, BC-348 original condition or converted to 115 V. A.C., BC-312, BC-342, Test Equipment, etc. All letters will be answered promptly. Please list equipment and give prices wanted.

TEST EQUIPMENT FOR SALE

IE-19A Test Set for SCR-522—Complete with manual, original factory packing BRAND NEW	\$325.00
LM Type Frequency Meter with calibration book	79.50
LM Frequency Meter Power Supply—115 V. A.C.	39.50
BC-906 Frequency Meter EXCELLENT USED	12.95
TS-13/AP Test Set, like new	375.00
TS-16/APN Test Set for APN-1 Altimeter	69.50
BC-221 Frequency Meters GOOD COND.	79.50
I-222 Signal Generator EXCELLENT COND.	75.00

SOUND POWERED HEAD AND CHEST SETS—T.V. INSTALLATIONS

Field Telephones Home Installations
Light Weight Type
Manufactured by U. S. Instrument Corp.
Excellent used . . . \$4.95 per set \$8.50 per pair
Fair used—
Tested 2.95 per set 5.00 per pair

MINE DETECTOR SCR-625 for locating metal, underground pipes, etc., with manual NEW \$69.50
GOOD USED 39.50

SN RADAR Transmitter-Receiver with antenna—Operates on 115V. A.C. Portable EXCELLENT USED \$500.00

TRANSFORMER—200-0-200 @ 50 ma. 6.3 V. @ 3 amps. 115 V. Primary. NEW \$1.45
TRANSFORMER—700-0-700 @ 75 mls. 6.3 V. @ 1.2 amps. 5 V. @ 3 amps. 115 V. Primary 60 cycles NEW 1.95

BC-375 TRANSMITTERS complete with tuning units, plugs, dynamotor, mountings, and microphones. NEW	\$ 89.50
ATD TRANSMITTER—540-9050 KC. 50W. CW and Phone, Complete with tubes, coils, dynamotor. NEW	175.00
BC-222 WALKIE-TALKIE—Frequency 28-52 mc. with crystal—less tubes, battery, and antenna. NEW	14.50
BC-684 TRANSMITTER with tubes—Frequency 27-38.9 mc. Excellent mobile—25 watts. EXCELLENT COND.	12.95
MN-26C BENDIX COMPASS RECEIVER—150-1500 K.C. with dynamotor, tubes, shock mounting. EXCELLENT COND.	19.50
APN-4 Indicator Scope and Receiver Power Supply with tubes and crystal GOOD USED	39.50

Plug for APN Scope and Receiver—Complete Set NEW \$3.75
Mountings for APN-4 Scope and Receiver EACH 2.00

WESTON TACHOMETER GENERATOR model 724 Type C GOOD USED \$12.95
WESTON ELECTRICAL TACHOMETER METER Model 545 for use with 724 Generator. Speed 0-2000 R.P.M. Ratio 2:1 NEW 14.50

HIGH VOLTAGE OIL CAPACITORS— BRAND NEW

1. mfd. 15,000 WVDC General Electric Pyranol	\$14.95
.65 mfd. 12,500 WVDC Cornell Dubilier	12.95
.02 mfd. 20,000 WVDC Cornell Dubilier	4.95
.5 mfd. 25,000 WVDC Western Electric	3.00
1. mfd. 6000 WVDC Westinghouse	5.95

PLUGS

PLQ-171, PL-172, PLQ-60, PLQ-63, PL-147, PL-148, PL-151, PL-152, PL-153, PL-154, PL-156, PL-103. PLUGS FOR: ARC-1, ARC-3, ARC-5, BC-375, SCR-522, BC-348, GP-6, GP-7, LM Freq. Meters AND many others. Write to us regarding your requirements.

BC-348 Mounting Base NEW	\$2.25
BC-348 Outlet Plug NEW	.69
BC-348 Mounting Base and Outlet Plug NEW	2.50

I.F. Transformers for SCR-522—1st, 2nd, and 3rd. EACH, NEW	\$ 1.95
CD-501 Cable for PE-103 BC-654 NEW	1.95
SPEAKER 6" Compartment P.M. Weather-proof—25 watts. EXCELLENT	7.75
FL-8 Range Filter NEW	1.95
HS-23 Hi Imp. Headset with ear cushions NEW	2.45
CD-307 Extension Cord for HS-2349
MC-385D Headset adapter35
ASD Radar Scope with 5FP7 USED	2.95
HS-30 Headset—Complete with matching transformer, 6' cord and PL55 plug. NEW	1.95
Dynamic Headset and Mike—P.O. Mark II NEW	1.95

BC-464 TARGET RECEIVER 5 channel Remote Sensitive Relays, Battery Case, Antenna, 6S-73 mc. BRAND NEW \$14.95

Crystal and Coil Sets for Handy-Talkies 2670, 3885, 4280, 4840, 5327.5, 5437.5, 5500 K.C.—2 Crystals and 2 Coils per set. PER SET NEW \$1.95
APN-1 Altimeter Indicator, basic movement 0-1 ma. 5 ma. shunt, 270° dial. An excellent basic movement for constructing your own meters. BRAND NEW 1.95

BC-620 MOBILE FM TRANSCEIVER—20 to 27.8 mc. with tubes. EXCELLENT COND. \$14.50
PE-120 POWER SUPPLY for BC-659 or BC-620—6 or 12 V. D.C. Excellent condition with tubes. 9.50

SCR-522 EQUIPMENT

SCR-522 TRANSMITTER-RECEIVER UNIT WITH TUBES. EXCELLENT COND.	\$59.50
PE-91 24 volt Dynamotor power unit for SCR-522 NEW	4.50
BC-602 Control Box NEW	1.50
BC-631 Jack Box NEW	.95
AN-104A Antenna NEW STEEL COPPER	3.95

TERMS: Prices f.o.b. Pasadena. 25% on all C.O.D. orders. Californians add 3% sales tax.

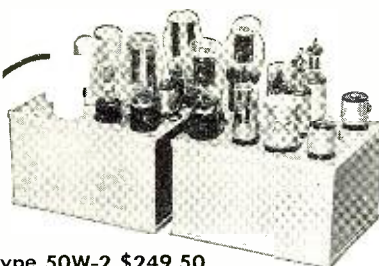

Type 50W-2 \$249.50

such as a speaker or cutter head, not just into an ideal resistive load. McIntOSH 50W-2 and 20W-2 amplifiers perform substantially the same under dynamic conditions into a speaker load, as into a pure resistive load.

Full dynamic range can be realized only if the noise is low. McIntOSH amplifiers are designed so that the noise compo-

AUDIO power peaks reach 200 to 400 times the average power of speech and music. The unique design of McIntOSH amplifiers provides adequately for such peak power requirements.

A bass drum delivers 140 decibels above threshold at 20 cycles, and a cymbal delivers 120 decibels above threshold at 20 kc. McIntOSH amplifiers, delivering full-rated power at all frequencies from 20 cycles to 20 kilocycles with less than 1% distortion, satisfy this requirement of dynamic range.

The ear is extremely sensitive to distortion. For completely enjoyable reproduction, intermodulation at peak powers must not exceed 1%. McIntOSH amplifiers type 50W-2 and 20W-2 meet that requirement for 100-watt and 40-watt peak powers, respectively, regardless of the frequency combination within the band of 20 cycles to 20,000 cycles.

Here is another important specification: Be sure to choose an amplifier that works properly with a variable impedance load

Type 20W-2

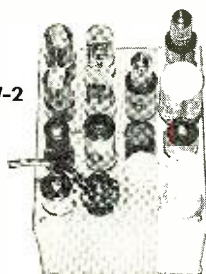

\$149.50

nents (rms) are 80 to 90 decibels below full rated output, which is an inaudible noise level.

Factors of economy should not be overlooked. The efficiency of McIntOSH amplifiers almost equals class B, with the highest theoretical efficiency possible. They are the most economical on tubes and power requirements—the most watts at the lowest distortion at the least cost.



Type AE-2 \$74.50

Service is simplified by plug-in circuits. Size is small because of the high efficiency.

Performance of the control unit should compare with the amplifier. The McIntOSH AE-2 8-stage Amplifier-Equalizer provides stable, distortion-free performance that matches the performance of the 50W-2 and 20W-2 amplifiers.

Engineers agree that McIntOSH amplifiers reach the practical limits of low distortion and high efficiency. Music lovers agree that the theoretical advantages are fully reflected in superlative audio reproduction. For further information write or telephone:

McIntosh
Engineering
Laboratory Inc.
910 KING STREET JUNIPER 7,200 SILVER SPRING, MD.

FOR THE "GOLDEN EAR" CROWD

THE STRAIN-SENSITIVE PHONOGRAPH PICKUP

Here's why this truly faithful reproducer appeals to people gifted with the "Golden Ear" . . . why the STRAIN-SENSITIVE PICKUP developed by the PFANSTIEHL CHEMICAL COMPANY brings out the brilliance of great voices and orchestras . . . the latent music on your records that other pickups leave untouched.

- The STRAIN-SENSITIVE PICKUP is an amplitude transducer with a **CONSTANT RESISTANCE** of about 250,000 ohms.
- Signal output is at a practically **CONSTANT IMPEDANCE** level.
- Excellent transient response.
- **NO DISTORTION**, phase shift or evidence of intermodulation is audible.
- **LINEAR RESPONSE** free from peaks or resonances.



Cartridges for micro-groove (.001 tip radius) and standard groove (.0027 tip radius) are available along with a Quick Change Cartridge Holder.

Styli are tipped with famous PFANSTIEHL M47B Precious Metal Alloy which will wear to less than a .003 flat in 100 plays on standard records at proper stylus pressure. Strain-Sensitive Elements equipped with Diamond styli are also available.

A special preamplifying circuit is necessary for operation of this new pickup. Four styles of preamplifiers with and without power supply and continuous tone controls are available, and are engineered to provide the correct D.C. voltage for the pickup element, and also to provide the first stages of signal gain.

Proof of the excellence of the STRAIN-SENSITIVE PICKUP is apparent both in tests and in actual listening, when its wide range flat response is best demonstrated. Ask your radio supply man or use the handy coupon below to get complete FREE INFORMATION.

PFANSTIEHL CHEMICAL COMPANY

101 Lake View Avenue, Waukegan, Illinois

PFANSTIEHL CHEMICAL COMPANY
101 Lake View Avenue, Waukegan, Illinois
Send me complete free information about the new PFANSTIEHL STRAIN-SENSITIVE PICKUP.

Name _____

Address _____

City, Zone & State _____

My Radio Supply House is _____

Address _____

attenuation of 6 db. per octave was chosen. Networks with greater rates of attenuation change usually bring about losses in the transmitted band with a corresponding lowering of efficiency. Use of large air core coils made it possible to attain the unusually small insertion loss of 0.3 db. The use of an air core prevents distortion characteristic of iron cores, which are subject to variation of permeability with frequency and power level.

The individual units were designed with response characteristics such that their respective contributions were small outside the crossover regions. This condition, with the network chosen, made it possible to achieve a new low in distortion over the entire audio band.

To allow compensation for sound absorption variations to be expected under different room conditions, the three-step semi-fixed "Room Brightness Control" is available. By means of this adjustment the balance between high and low frequencies may be changed to correct for different selective absorption conditions.

In cases where the frequency range of the source material or associated equipment is restricted, or where a higher-than-tolerable percentage of distortion exists, high frequency cut-off of the loudspeaker may be restricted. This is provided by an adjustable four-step, low-pass filter

which restricts the response in graduated steps to as low as 4000 cycles. However, a long program of listening tests has clearly shown that, even when working with the frequency range "wide open," the G-610 is tolerant of distortion in source material.

An "L" pad level control allows precise over-all volume adjustment at remote mounting positions to make the loudspeaker suitable for use in remote installations without the need for additional external controls.

The ultimate test of loudspeaker performances requires that it be listened to and the subjective effects which it produces in the listener must be evaluated by *people*. What is desired in a loudspeaker of highest quality is "transport to the original"—the production of the same sensations which would be experienced if the listener were actually at the original performance, and complete freedom from any and all effects which mar the illusion of reality. The extent to which this transport could be achieved was an unknown and the subjective value which listeners would place upon theoretically improved performance (in the face of existing high performance speakers) could only be speculated upon until the G-610 was completely designed.

Field experience with the Triaxial has fulfilled the expectations of its designers.

-30-

OSCILLATION IN PHASE INVERTERS

By LAWRENCE FLEMING

PHASE inverters often exhibit parasitic oscillations at frequencies around 50 kc., leading to heavy distortion and instability. The remedy is to bypass the cathode resistor of the phase inverter stage with 0.1 microfarad or more.

Parasitics at ultrasonic frequencies are quite a common cause of mushiness and low power output in audio amplifiers. Fortunately they show up at once on an oscilloscope although without a scope they are difficult to detect. If the trouble seems to depend on the gain control setting, it points strongly to parasitics.

Fig. 1 shows a conventional "floating paraphase" inverter in which the writer encountered this effect. It was found that the oscillations could be stopped by

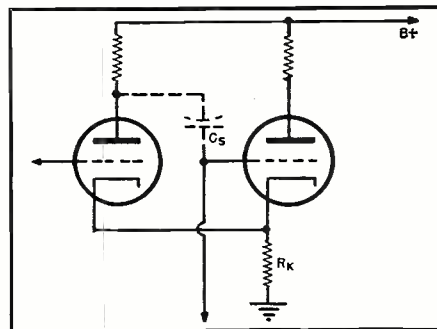
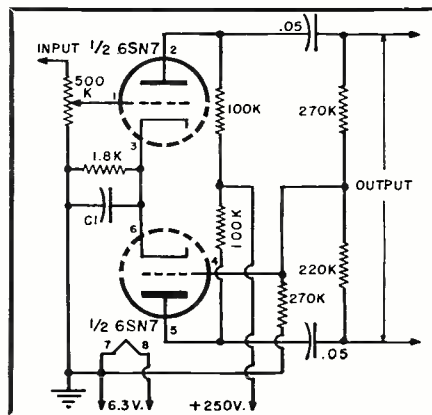

Fig. 2. Stray capacitance makes cathode-coupled multivibrator out of a standard phase inverter, creating parasitic oscillations.

Fig. 1. Phase inverter with cathode bypass, C_1 , used to kill parasitics.



a 200 micromicrofarad condenser from the top plate of the tube to ground. To avoid cutting down the high frequency response another cure was sought. A small bypass, C_1 , did the trick. 0.1 microfarad was adequate, but a 25 microfarad electrolytic was put in for good measure.

It turns out that stray capacitance from the plate of one triode to the grid of the other can make this type of circuit into a cathode-coupled multivibrator, as shown in Fig. 2. Here, one triode is coupled to the other through the common cathode resistor R_k , and the return coupling for oscillation comes through the stray capacitance C_s . In all kinds of inverters, it is advisable to keep this capacitance from the plate of one triode to the grid of the other, as low as possible, by proper lead dress and layout.

-30-

Special Relays - OVER A MILLION IN STOCK!

Whether you require large quantities of relays for production runs or single units for laboratory or amateur work, Wells can make immediate delivery and save you a substantial part of the cost.

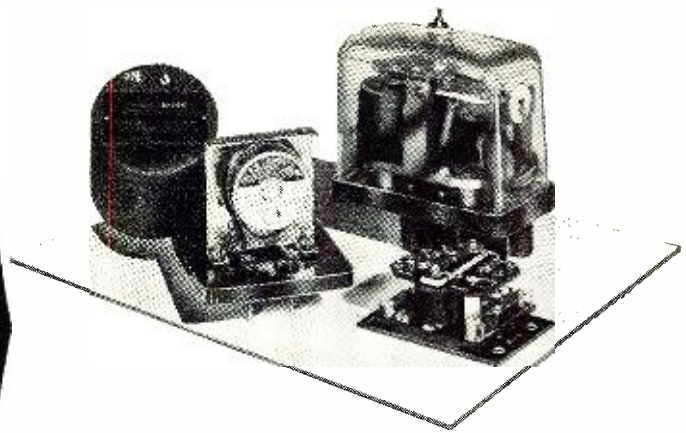

This list represents only a few types of Special Relays. We also have huge stocks of Standard D.C. Telephone Relays, Midget Relays, Contactors, Keying Relays, Rotary and Slow Acting Types as well as many others. Write or wire us about your requirements.

STOCK NO.	VOLTAGE	OHMAGE	CONTACTS	MANUFACTURER & NUMBER	PRICE
R-503	12/32 VDC.	100	3A, 2C	G.E. Ant. Keying 500W 2C6530-653AR1	\$ 2.25
R-749	600 VDC.	...	Max. 28 Amps.	Allen Bradley 810 Dashpot	5.95
R-804	550 VAC.	...	1B/38 Amps.	Cullter Hammer C-261173A34 Contactor	3.50
R-250	115 VAC.	...	Adj. Cir. Breaker .04-.16A	Westinghouse MN Overload	12.95
R-579	220 VAC.	...	1B	Adlake 60 Sec. Thermo Delay	6.95
R-294	27.5 VDC.	200	1B	Edison 50 Sec. Thermo Delay	4.25
R-686	115 VAC.	...	2C	Leach 115T-5/20 Sec. ADJ. Delay	4.95
R-246	115 VAC.	...	1B	Cramer 2 Min. Adj. Time Delay	8.95
R-246A	115 VAC.	...	1A	Cramer 2 Min. Adj. Time Delay	8.95
R-611	24 VAC.	...	1A/30 Amps.	Durakool BF-63	4.25
R-283	12 VDC.	125	AC 10 Amps.	Onan Rev. Current 3H4512 R24	1.00
R-614	18/24 VDC.	60	1A, 15 Amps.	Rev. Current Cutout 3H2339A/E1	3.50
R-262	200	1C	W. U. Tel. Co. 41C Single Current	3.75
R-245	12 VDC.	25	4 In. Micalax Lever95
R-527	6/12 VDC.	50/50	In Series	227668 For Scr-274N	.95
R-544	12/24 VDC.	60/60	1C	G.E. Push Button Remote Relay
R-255	1A	#CR2791-R-106C8	1.65
R-669	75 VAC.	400 CYC.	1B, 1A	G.E. Pressure Switch #2927B100-C2	.95
R-660	6 VDC.	...	3/8" Stroke	Clare 400	.95
R-651	24 VDC.	100	Solenoid Valve	Cannon Plunger Relay #13672	.95
R-295	12 VDC.	275	Annunciator Drop	2.50
R-230	5/8 VDC.	2	2A, 1C	Guardian Ratchet Relay	2.15
R-813	12 VDC.	12	Wafer	Ratchet Relay From Scr-522	4.25
R-275	12 VDC.	750	1A, 1B, 1C	Guardian BK-10	2.75
R-716	24 VDC.	70	2A, 5 Amps.	BK-13	1.45
R-620	6/12 VDC.	35	2C, 1A	Guardian BK-16	1.05
R-629	9/14 VDC.	40	1C 10 Amps.	Guardian BK-17A	1.25
R-778	8 VDC.	4500	1C 5 Amps.	Kurman BK-24	2.10
R-720	24 VDC.	50	2C. Ceramic	45A High Power	1.35
R-500	12 VDC.	10/10	2C/6 Amps.	Str. Dunn. Latch & Reset	2.85
R-816	12 VDC.	10/15	2C/6 Amps.	Guardian Latch & Reset	2.85
R-811	48 VDC.	8000	1C	Sigma 4R	1.65
R-524	24 VAC/DC.	Edwards Alarm Bell	.95
R-838	90/120 VDC.	925	2A	Allen Bradley-Bulletin #702
R-839	100/125 VDC.	1200	3A	Motor Control	4.50
R-840	115 VDC.	1200	2A	Allen Bradley-Bulletin #200E
R-841	115 VDC.	1200	4A	Motor Control	4.50
R-842	115 VDC.	925	3A	Allen Eradley-Bulletin #209 Size 1
R-843	115 VDC.	1200	3A	Motor Control W/Type "N" Thermals	5.50
R-844	115 VDC.	1200	3A, 1B	Allen Bradley-Bulletin #709 Size 2
R-845	220 VAC.	Intermit.	3A	Motor Control W/Type "N" Thermals	25.00
R-831	7.5/29 VDC.	6.5	1A/250A, 1000A Surge	Allen Bradley-Bulletin #709
R-837	110 VAC.	...	2A/30 Amps.	Motor Control W/Type "N" Thermals	5.50
R-835	24 VDC.	2800	1A Dble. Brk./10 Amps.	Allen Bradley-Bulletin #200
R-836	220 VAC.	...	2A Ddle. Brk./10 Amps.	Motor Control	4.50
R-566	115 VAC.	(Coil only, Not a complete relay)	Allen Bradley-Bulletin #202
R-710	150-Ohms. Coil Only	Motor Control	4.50
				Allen Bradley-Bulletin #704
				Motor Control	4.50
				Leach B-8	3.50
				Leach 6104	2.75
				Wheelock Signal, B1/39	1.95
				Wheelock Signal, A7/37	3.45
				Leach #6104	.75
				Guardian #38187	.50

Write For New Wells Catalog

Each relay is new, individually boxed, and unconditionally guaranteed by Wells

World's Largest Display of Radio and Electronic Components

9,000 Square Feet of Display All On One Floor



320 N. LA SALLE ST., DEPT. R CHICAGO 10, ILL.

November, 1950

125

(Advertisement)

Your Future In COLOR TELEVISION

By

Milton S. Kiver
Television
Consultant,
Radio & Television
News



HOW LONG CAN YOU AFFORD TO WAIT?

The recent FCC decision, discussed elsewhere in this issue, shows how really close we are to color television. Trained television technicians capable of servicing the complex black-and-white sets and the even more complex color television circuits will be the ones who will command respectable positions and high salaries.

The radioman of today who recognizes this growing demand for trained television servicemen . . . who acts by preparing himself now with the proper training and information . . . is the man who is insuring his future.

PROPER TRAINING: A KEY TO SUCCESS

Every practical man knows that to learn TV servicing the right way, you have to do actual TV servicing. You have to know how to locate troubles quickly . . . repair them efficiently. Some men are fortunate enough to be able to attend school. A good many others cannot leave their jobs and so must get whatever they can at home. Fortunately, there is a training program available that teaches you television servicing in a practical, learn-by-doing way.

It's a home study program in which you learn up-to-date practical, professional television servicing in your spare time—without leaving your present job. Included in this course is information on testing, troubleshooting, repairing and servicing of all types of TV sets plus set conversion, master antenna installation, printed circuits and many field servicing short cuts. In addition, a complete section on Color TV is also included. As developments take place in Color TV, this section will be expanded accordingly.

PRACTICAL EXPERIENCE IS ESSENTIAL

To give you the experience you need, you build and service a 29-tube RCA 630 TS type television receiver (12½, 16 or 19" tube) which is furnished as part of the course and which is yours to keep. You are loaned testing instruments. As an optional feature, you can get two weeks of actual field experience going out on service jobs and working on the repair bench for Chicago's largest independent television servicing organization. So practical is this course that after the first few lessons you can start earning money doing actual television servicing!

You can get complete information on this practical television servicing course as well as sample lessons. Just write Television Communications Institute, 205 W. Wacker Dr., Dept. 1-B, Chicago 6, Ill.

Color Decision

(Continued from page 65)

wheel. Such tubes have indeed been developed but they are still quite crude. However, there is good reason to believe that color tubes will be perfected and when this happens then it may be possible to replace your present black-and-white tube with a color tube. But this is at least 2 to 4 years off. Bear in mind that when the time does come it will not be a simple operation to convert the set. The new color tube will require quite a number of changes and additions, circuit-wise.

If the Commission's suggestions are adopted by television manufacturers, then after about November 12th of this year (unless the FCC extends this date to give manufacturers additional time), all new sets will contain switching circuits permitting them to operate on the present black-and-white standards as well as the CBS color standards. Note again that these

sets will not be color sets but will merely permit reception of color programs in monochrome.

So much for the consumer. Now let us look to the set manufacturers. If they agree to the Commission's proposal for the adoption of the double standards, then the Commission will not make any final decision authorizing the CBS color system as standard. Instead, it will make further investigation into the color question to determine whether any new developments or systems have been brought to light, since the hearings closed, which will provide better results than the CBS system as it is now constituted. By having the manufacturers agree to the double-standards proposal, the FCC feels that compatibility then is no longer of interest and a color system can be chosen on the basis of other, more important properties.

But suppose the receiver manufacturers do not agree to make the foregoing changes? Then, says the Commission, every passing day will find the compatibility problem aggravated

Fig. 1. Schematic diagram of an automatic scanning adapter designed specifically for the Bendix Model 235M1 TV receiver. It is possible to simplify the circuit by using a manually-operated switch in place of the automatic feature. This adapter was built by E. Chapin and W. Roberts of the FCC laboratories at an approximate cost of \$16.34. There are many other television receivers in the field today that cannot be as easily converted as this Bendix set. Estimated costs for converting black-and-white receivers range all the way from \$25.00 to \$100.00, including the cost of the labor involved.

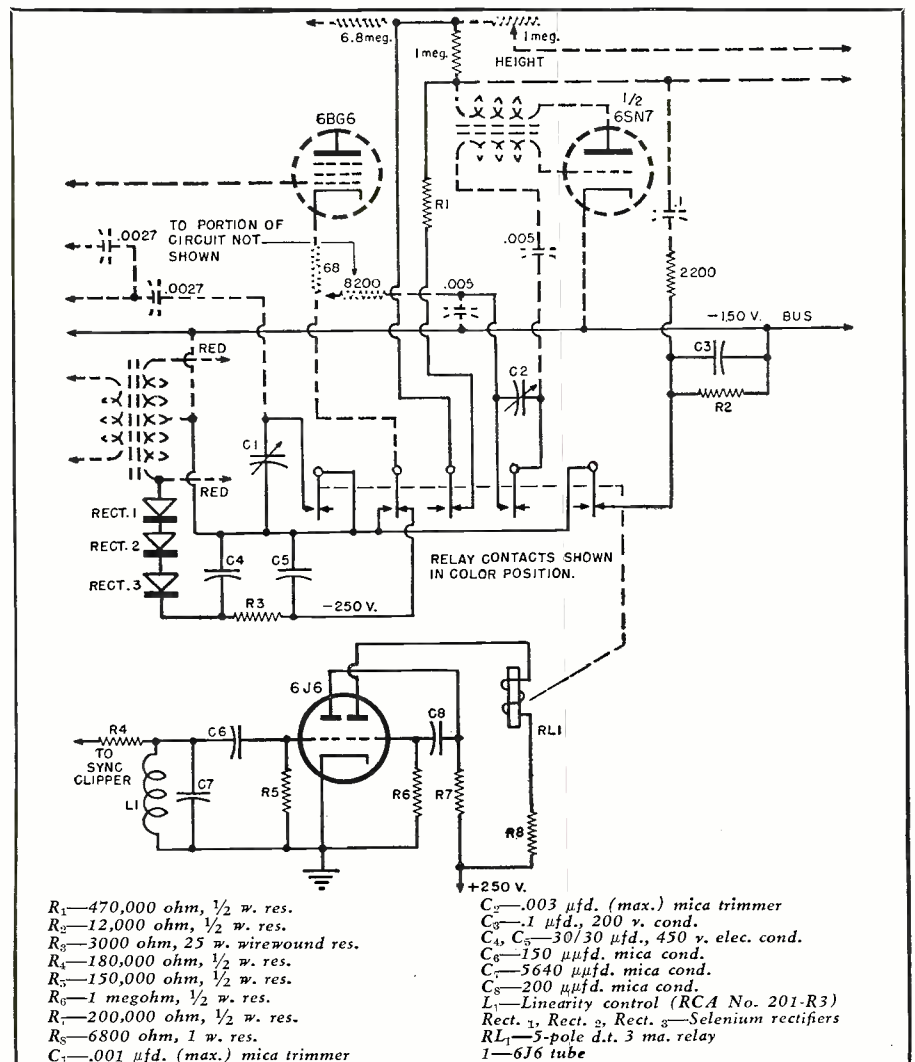

- R₁—470,000 ohm, ½ w. res.
- R₂—12,000 ohm, ½ w. res.
- R₃—3000 ohm, 25 w. wirewound res.
- R₄—180,000 ohm, ½ w. res.
- R₅—150,000 ohm, ½ w. res.
- R₆—1 megohm, ½ w. res.
- R₇—200,000 ohm, ½ w. res.
- R₈—6800 ohm, 1 w. res.
- C₁—0.01 μfd. (max.) mica trimmer

- C₂—0.003 μfd. (max.) mica trimmer
- C₃—1 μfd., 200 v. cond.
- C₄, C₅—30/30 μfd., 450 v. elec. cond.
- C₆—150 μfd. mica cond.
- C₇—5640 μfd. mica cond.
- C₈—200 μfd. mica cond.
- L₁—Linearity control (RCA No. 201-R3)
- Rect. 1, Rect. 2, Rect. 3—Selenium rectifiers
- RL₁—5-pole d.t. 3 ma. relay
- 1—6J6 tube

GIBSON GIRL

The Emergency Radio Transmitter. Send S O S signals automatically on 500Kc. 150-mile range. No batteries required. Has hand-driven generator, tubes, etc. New. It's only... \$3.95



RL 9 or RL 7
Interphone Amplifier Convert to High Fidelity Phone Amp. or Speech Amp. Compl. w/ 2AG, 12-17, 2 Chokes, 1XFRMR, DYN for 24V operation, etc. \$2.29



Aircraft Receiver for Mobile or Aircraft Covers 100 to 201 Kc up by 1 Kc. Includes change plug in tuning unit includes one Tuning Unit, Less Tubes, Rec. Only a few left. \$3.95 ea.

R5/ARN7 Compass Rec ADP Rec 100-1750 Kc. in 4 bands 5 gang Tuning Capacitor w/15 Tubes. Phone for price.

6V Input Dynamo Output 150V/75MA or 12V Input, 500V/50MA Out. \$3.49

FEED THRU
2 1/4" L x 1 3/4" W Type X31 10c ea.
10 For 50c



COMMUNICATIONS EQUIPMENT for your needs

There is no shortage of Surplus Equipment at C.E.C. Our warehouses are full of all the electronic equipment you require at **SURPLUS PRICES**. We own what we sell. Write us your needs and let us quote.
Mr. Chas. Rosen, Digby 9-4124

HEINEMAN Ckt Bkrs for AC-DC operation.

AP1510M	7 AMP
1614	80 AMP
1614	50 AMP
1000	100 AMP
Price ea.	\$1.10
P-0322 Dual 10 Amp	
Price ea.	\$2.25

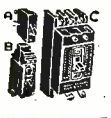

METERS

0-5MA SQ 2 1/2 Metal Case or 0-10 volt movement readrite meter 98c

0-30V DC Meter Westing. Type AX Aircraft type. Price \$2.49
Multimeter Mvmt. 0-100 Meg, 0-600/50/14VDC (0-5 MA Basic) 3" Rd Metal Sim to Sipsen #23 \$3.95
100-0-100 Microamp 4 1/2" Iake. Same as Model 801 (Weston). Mig by Sun Elect & Beede Elect. Model 4AW271.
Price ea. \$8.75
0-1MA 3 1/2" Rd Defude Mod S-310. Price ea. \$4.75
0-1MA 3 1/2" Rd. Same as above. Mig Sun Mfg. Mod 3AP259. Price ea. \$3.95
0-10MA 3 1/2" Rd. Defude Mod S-310. Price ea. \$4.65
0-10MA 3 1/2" Rd. Same as above. Mig Sun Mfg. Mod 3AP236. Price ea. \$3.95
0-200 Microamp 4" Sq. Bake Boston #741. Price ea. \$12.95
0-200 Microamp. Sim to above. Sun 4AW371. Price ea. \$7.50

CHOKO SWINGING

9/60Hz .400/.05 Amp 10000V ins. Mfg Super Elect \$7.95

FT234A 274N Single Xmtr Rack. New. \$1.69

AMPLIFIER

AM-32/PR51 less batt w/carry case for Mine Detector AN/PR51. Price ea. \$7.95

Horsie Talkie BC745 Xmtr Revr 3-Gmc w/ITU Less Pwr Supply. \$11.95

PE157 Vibronack for above 2V in. from storage batt in case which is charged from 6V AC or DC contains 5 Speaker & Jacks for Mike & Hdset. Used. exc. cond. \$9.95

LP21 LM Radio Compass Loop. Excellent condition. \$10.95

LM Freq. Meter. No calibration Book used. Fair As Is. Less Xtal. Special \$22.50

TVI Line Filter 110VAC 1 Amp Reject Range .15-150 MC Chassis Mt. Herm sealed 1 1/8" x 1 1/2" x 3 1/2". Price 69c

GP7 Aircraft XMTR. Fair Condition. As Is. Less T. U. \$19.95

Avail. in Stock. Dual XMTR & Dual Rec. Triple Rock Mounts MTR63-1MT 65-MT71 Bent & Banged Up. Sold As Is. No Refund. Repairable \$1.00 ea.

CABLE CLAMPS

Tinn #1, 3, 4, 6, 7A, Lock Type Rubber 6c ea. 10 for 55c.

Line FILTER, GE 100 Amp Filter w/25Mfd 50V 611 cond. Operation on 110V AC DC. \$1.99

Aircraft Radio Transmitter CRV 5223: 28VDC. ATB Battery. RCA less T. U. As Is. \$39.95

R-9A APN4 Loran Rec Power Supply 400 cy 3RFS Quad. Tuned switches, connectors, etc. N.G. As Is. Less Tubes. \$14.95

ID6 APN4 Scope 5" Loran. Full of Resist. Micns Basic Assy for Scope. N.G. As Is. Less Tubes. \$12.95

BC433 Mod or unmod CW Reception 200-1750Kc in 3 bands 14 or 24V & 115V AC ADP. Radio Compass As Is. Less Tubes. Poor Condition ... \$11.95

BC929A 3RP1 Scope Indicator containing Ant. Switch & Motor w/Tubes 3-6HG7, 2-6SN7, 1-6H6, 1-6X5, 1-3BP1, 1-2X2, P/O SCR 729 & APN2. New ... \$25.95 w/Conv. Dia. to 110V 60 cy.

Motor Driven Yagi Switch 24V 1800 RPM. Price \$3.95

BC434 CONTROL BOX Remote Control for 433 Radio Compass contains 0-5MA Meter, Dial Control \$3.95

Voltage Stabilizer VR3 95-130V 2.4A 60cy id on 115V 120V 100% Raytheon w/EXT. 1X Box. Sockets, Cable. Used but good. Price \$19.95

BATHTUB CAPACITORS

MFD	VOLT	TYPE	PRICE EA.	10 FOR
.5	600	2ST	\$.25	\$2.40
.5	400	2BT	.23	2.20
.5	600	2TT	.25	2.40
3X.1	600	3TT	.45	4.35
3X.1	600	3ST	.45	4.35
2X.1	400	2BT	.28	2.80
2X.1	600	3ST	.28	2.85
2X.1	600	3BT	.28	2.65
2X.1	400	2TT	.26	2.50
2X.1	600	2ST	.26	2.50
2X.1	600	2BT	.26	2.50
2X.1	600	3TT	.26	2.50
1-1-.025	400	3ST	.28	2.65
.1	600	2BT	.22	2.10
.1	600	2TT	.22	2.10
.1	600	2ST	.22	2.10
.13	600	2ST	.25	2.20
2X.25	600	3ST	.70	8.50
.05	600	3BT	.21	2.10
1	100	3TT	.23	2.30
20	50	2ST	.26	2.50

VARIABLE 7 GANG

Cardwell, Two 200Mmf. One 75Mmf Sect's. Worm Drive Assy and 0-30 Calib Dial 5/16 shaft. 1 3/8 Lg. Price..... **\$1.95**

VARIABLE ARC 5

6-9.1 Mc Condenser. 90:1 Drive Gear Ratio. 3 Sections. Price..... **\$2.25**

CERAMIC TRIMMER

Stack of 6 Ceramic Trimmers 110-460Mmf. Can be used singly or ganged..... **69c**

VERNIER 3 GANG

Precision Assy used for single dial Control up to 75 watt, 2 single spaced 25MmfMfd Sect's & Heavy Double Spaced Sect's. 50:1 Ratio. Spring loaded Ceramic Ins. 4" Metal Dial..... **\$3.25**

COLLINS ART-13

FREQ. MULT. UNIT 2-18 Mc for two 1625 Tubes. Comp Assy less Tubes & Coils w/ekt diag. Price..... **\$8.95**

ANTENNA MAST

Are you in a dead spot? If you can't get a good T.V. picture here is a sig. Corp. Ant. mast 30' high of rugged plywood construction to solve your problem. It telescopes into 3 ten ft. sect. for easy storage. Easy to Mt. Comp. with stakes & rods. Each **\$19.95**

MS49 and MS50 Dipole Antenna, 74" long. Both for \$49c

Hi Gain Dynamic Mike Xfmr

Comb. hi-gain DynMikeXfmr 15V/500V Elec. 3vdc. 60ohm CT&4000 ohms Tapped 25x150 ohms. Fully Shielded H's/d. Price Each..... **49c**

SERVO AMPLIFIER

A-5 Automatic Pilot L. Less tubes contains sockets, bathtub cond, trans audio, etc. Special 95c ea.

400 MA 12 HY Choke 90 ohms Herm. sealed. Special ... \$3.75

TUNING UNITS FOR BC 223 XMTR

TU17A 2000-3000Kc	\$2.75
TU18 3000-4500Kc	2.25
TU23 3500-5200Kc	2.25

Tuning units for BC191

TU5 1500 - 3000Kc	\$3.75
TU6 3000 - 4500Kc	2.85
TU7 4500 - 6000Kc	2.95
TU8 6200 - 7700Kc	2.49
TU9 7700 - 10000Kc	2.49
TU10 10000 - 12500Kc	2.49
TU26 200 - 500Kc	2.49

Write for quantity prices

Voltage Regulator VH623 95-130V 1.75A 60cy 1d CU 115V 150W 100%. Slightly used. Excellent. Price..... **\$19.95**

MICA CAPACITORS SOLAR XMB TAPPED POLES

Mfd.	Price
.00001	\$0.35
.000025	.35
.00003	.35
.00005	.35
.000075	.35
.0001	.35
.00015	.35
.0002	.35
.00025	.35
.0003	.35
.0004	.40
.0005	.40
.00075	.40
.001	.50
.0015	.50
.002	.50
.0025	.50
.003	.55
.0035	.55
.004	.75
.005	.75
.006	.95
.007	.95
.008	.95
.009	.95
.01	.95
.015	1.25
.02	1.25
.025	1.30
.03	1.35
.035	1.45

5000 V Test
.0015 1.75
.002 2.00

Solar XQ Solder Lugs
2500 V Test
.01 1.25
.02 1.30
.03 1.30
.04 1.75
.05 1.75
.06 1.75
.07 1.75
.08 1.75
.09 1.75
.10 1.75
.15 1.75
.20 1.75
.25 1.75
.30 1.75
.35 1.75
.40 1.75
.45 1.75
.50 1.75
.55 1.75
.60 1.75
.65 1.75
.70 1.75
.75 1.75
.80 1.75
.85 1.75
.90 1.75
.95 1.75
1.00 1.75
1.05 1.75
1.10 1.75
1.15 1.75
1.20 1.75
1.25 1.75
1.30 1.75
1.35 1.75
1.40 1.75
1.45 1.75

PHOTO PRINT DRYERS

Consists of nicrome element insulated from open frame 9 3/4" x 10" 110V 60 cy 75c

LEARN OR TEACH CODE

Uses 6-12-24-115V DC, 115-230 VAC. Can use hookup of over 20 students. Contains speaker, blinker, freq. control, etc. in fiber trunk 17"x19"x10 1/2". New.

DYNAMOTORS AT SURPLUS PRICES

Type	Input Volts	Input Amps	Output Volts	Output Amps	Radio Set
PE 86	28	1.25	250	.060	RC 36
DM 416	14	6.2	330	.170	RU 19
DY-2/ARR-2	28	1.1	250	.060	ARC-5
DM 36	28	1.4	220	.080	SCR 508
PE 73CM	28	19	1000	.350	BC 375
DM 21	14	3.3	255	.090	BC 312
DM 25	12	2.3	250	.050	BC 367
DM 33A	28	7	540	.250	BC 456
DM 42	14	46	515	.110	SCR 506
			1030	.050	
			2/8		
PE 101C	13/26	12.6	400	.135	SCR 515
			6.3	.800	.020
BD AR 93	28	3.25	375	.150	
23350	27	1.75	285	.075	APN-1
33X045B	28	1.2	250	.060	
ZA 0515	12/24	4/2	500	.050	
ZA 0516	12/24	8/4	12/275	3/110	
B-19 pack	12	9.4	275	.110	Mark II
D-104	12		225	.100	
			440	.200	
DA-3A*	28	10	300	.080	SCR 522
			150	.010	
			14.5		
#5053	28	1.4	250	.060	APN-1
CW 21AAX	13	12.6	400	.135	
	26	6.3	800	.020	
			9	1.12	
BD 77KM	14	40	1000	.350	BC 191
PE 94	28	10	300	.260	SCR
			150	.010	522
			14.5		

N-New. LN-Like New. *Less Filter Box & Re-lays. Replacement dynamotors for PE-73, less filter box.

ARC/5 Transmitters

40 Watt Output These Famous V.F.O. Drivers Available



3-4 Mc. Good condition. \$6.95 Used.

932 PHOTO TUBE

Gas Photo-tube having S1 response, particularly sensitive to Red and Near Infrared Radiation. Can be used with incandescent light source. Send for data. Price..... **75c**



BC 405 INTERPHONE AMPLIFIER

Easily converted to an ideal intercom-munications set for office-home-or-factory. Complete diagram for 110V operation. Brand New..... **\$4.49** Used..... \$3.95



ARC 5 MODULATOR

MD7/ARC5 w/dynamotor complete w/Tubes 1-12J5, 2-16Z5, 1-UR50. Good cond. Price..... **\$8.95**



Super Pro Equip.

1st and 2nd RF 10-20 MC Coil P.T. SA111. RF ANT OPTP 2-3.5 MC COIL SA-116 ANT INPT 200-400 KC COIL SA161 ANT INPT 200-400 KC SA 48. HI FREQ OSC 2.5-5MC COIL SA118. ANT OPTP 10-20 MC Coil SA110. Price Each.... **65c**

1619-1619-1619 Octal Base Pentog Versatile High Pervance Tube... New **21c**
5 for \$1.00

M.O. COIL

1800-2250Kc P/o Collins 32RA Plug in **69c**



AUDIO XFRMRS

UTC 80707 oncer
PL to S. \$1.29
5119-Ouncer Pl. to line49
901-Pl. to V. coil. .75
6262-Pl. to Hdset. or line69
5640-Mike or Line
T922-ava Pl to 811 Gds 1.29
811 Gds 1.45
765-Line to Grd. .98
25-Pl. to Line. .98
837-1:1-1:2 Ratio .75
622-1:2-2:8 Ratio .75
9449-PPVE to PP95 Class B. 10 Watt. \$4.95
9446-Hi-160-15000CP 250W. Audio 9000-PP to 9-Voice Coil \$12.95
353 AB1 PP 616 to 250 V. 10 voice coils 20 25 watt \$3.95
631 Mike to PP Grids. 29c
831. Euy & Carbon Mike to PP Grids.79c

KITS

Silver & Mica Cndars. 30 for \$1.50
Electrolytics, Assd. 12 for 1.00
Vitroous W.W. Resistors. 20 for 1.00
Rotary Switches, Assd. 6 for 1.75
Coil Forms, Th'd Sn.Hf. 50 for 1.00
Iron Core Plug & Screw. 50 for 1.00
Elastic Stop Nuts, Assd. 50 for 1.00
Lugs, Large Radio/Elec. 100 for 1.00
Lugs, Small Radio Type. 300 for 1.00
Grommets, Rubber Assd. 100 for 1.00

All merch. guar. Mail orders promptly filled. All prices F.O.B. N. Y. C. send MO or Chk. Only shipping chgs. sent C.O.D. Rated Concerns send P.O.

COMMUNICATIONS EQUIPMENT CO.

131 Liberty St., New York, N. Y. Dept. N-11 Chas. Rosen Phone: Digby 9-4124
November, 1950



CO-AXIAL RELAY

Allied Control type RA, SPDT, 6VDC operated. Designed to handle a maximum of 75 Watts at 150 mc. Ideally suited for mobile rigs, TV antenna switching, etc. Uses standard co-ax connectors. **\$3.95** Each

10 for \$35.00
Set of 83-15P Co-ax connectors for above \$0.99

MISCELLANEOUS

HADAR SEARCH CENTRAL, incl. pulse analyzer—Price on Request.
 APA-10 PAN-ADAPTER \$149.50
 BC 348 Receivers, like new 159.50
 BC 221 FREQ. METERS, excellent cond. 79.50
 LAMPKIN FREQ. METERS 175.00
 BC 438 FREQ. METER, 195-235MC x 110V 60cy, with calibration chart & antenna 39.50
 0-15 AMP DC BENCH METER, NEW 4.95
 2" AIRCRAFT METER 0-30 VDC, 0-120 Amp DC, complete with shunt, NEW 4.95
 APN-1 altimeter transceiver, NEW 10.50
 RS9/ARN 5 receiver, with tubes, NEW 10.50
 100 KC precision crystal 5.95
 1000 KC xtal, \$3.95; 5 MC xtal 3.50
 BILLEY SMC-100 dual 100/1000 kc xtal 6.95
 BEACHMASTER output transformer, 250V 2.95
 FOUR QUADRANT PULSING ADAPTOR 9.95
 BC-733 receiver with tubes, NEW 9.95
 CRAMER time delay relay 120 sec. 120 vac. 9.95

METER SPECIALS

RD 3/4" 0-20 ua (C-100 Scale) \$14.50
 SQ 3/4" 0-200 ua DC 6.50
 SQ 2 1/4" 0-9 VDC99
 SQ 2 1/4" 0-100 AMP DC with shunt99

3" METERS

0-50 MA \$14.50	0-30 AMP AC WH \$5.95
100-0-100 ua 6.95	100-0-100 VDC, 0-200 VAC 5.95
0-500 ua GE 6.95	JBT 31-F FR.MTR. 7.95
0-1 MA S Scale 3.95	
0-1 MA DC 5.95	
0-2 MA DC 4.50	
0-15 MA DC GE 4.50	
0-15 MA DC WH 4.50	
0-30 MA DC GE 4.50	
0-30 MA DC WH 4.50	
0-50 MA DC WH 4.50	
0-80 MA DC WH 3.95	
0-100 MA DC 4.50	
0-150 MA DC WH 4.50	
0-200 MA DC GE 4.50	
0-300 MA DC 4.50	
0-500 MA DC 4.50	
0-1 AMP DC WH 4.95	
0-2 AMP DC Smp 7.95	
0-300 VDC SP 2.95	
0-750 VDC 7.95	
0-8 VAC WES 476 4.95	
0-15 VAC WH 7.95	
-10+5 DB WES 301 10.95	
0-150 VAC WH 4.95	
30-0-30 AMP DC 4.95	

2" METERS

0-500 ua SP Scales \$3.95
 0-1 MA DC SUN 3.45
 0-1-2 MA 998 3.45
 0-1 MA SP Scale 4.95
 Test Meter 0-200 MA and 0-2 Amp DC 3.95
 0-20 MA SP Scale 2.49
 0-50 MA 2.49
 0-25 MA SP Scale 2.49
 0-2 MA SP Scale 2.95
 0-3 VDC, 1 MA 3.50
 0-20 VDC 2.95
 0-30 VDC 3.50
 0-30 AMP DC 3.50
 0-10 VAC GE 3.50
 0-300 VAC Trp 4.95
 0-2 AMP RF SO 3.50
 0-9 AMP RF WH 3.50

CHOKES

200 HY 6 MA 620 OHM \$0.99
 8 HY 50 MA59
 10 HY 80 MA 240 OHM89
 20 HY 110 MA 87V Herm. Seal. 2.35
 10 HY 150 MA 140 OHM 1.39
 7 HY 200 MA 100 OHM Herm Seal. 3.49
 4-16 HY 200 MA 140 OHM SWINGING CH. 4.25
 4 HY 200 MA 20 OHM90
 3 HY 250 MA 15 OHM Herm Seal. 1.25
 15 HY 250 MA 60 OHM 6.20
 3-14 HY 300 MA 80 OHM SWINGING CH. 6.20
 6 HY 300 MA 65 OHM 4.95
 8 HY 300 MA 80 OHM 6.10
 6 HY 350 MA 20 OHM 4.95
 12 HY 400 MA 90 OHM Herm Seal. 4.95
 4 HY 450 MA 52 OHM 5.95

115V FILAMENT TRANSFORMERS 60 CY

2.5 VCT 10 A, 10KV Insulation \$3.95
 2.5 V @ 6 Amp, 2.5 V @ 6 Amp 3.45
 5 VCT 3A, 8 KV Insulation 2.35
 5 V 20 A, 2.5 KV Insulation 6.25
 6.3 V 1.2 A85
 6.3 V 3 Amps 2.14
 6.3 V 12 Amps 3.95
 6.3 V 3 Amps, 6.3V 3 Amps 3.75
 6.3 V 3.5 A, X 6.5 V 3 Amps ea. 3.49
 6.3 V 3A, 2.5 V AMP Herm Seal 3.49
 10 VCT 10 A, 2.5 KV Insulation 5.55
 6.3 V 4 Amps, 5 V 3 Amps 3.95
 6.3 V 12A, 6.3V X 2.5 Herm Seal 6.50

115V POWER TRANSFORMERS 60 CY

650 VCT 90 MA, 6.3V 2A, 5V 3A \$3.00
 700 VCT 90 MA, 6.3V 4A, 5V 3A 3.50
 610 VCT 160 MA 6.3V 3A, 5V 3A 4.34
 700 VCT 150 MA, 5V 3 Amp 2.95
 800 VCT 300 MA, 6.3V 10.8A, 5V 3A 9.35
 800 VCT 300 MA, 6.3V 10.8A, 5V 6A, 5V 2A 9.35
 800 VCT 200 MA, 6V 3A, 6V 4A 6.50
 300 V 100 MA, 22V VCT 100 MA, 6.3V 3.5A 2.95
 2.5V 10A 2.25
 750-600-0-600-750, 225 MA 8.75
 117V, 230V Trp, P=850V CT, 280MA-36V 7A-6.3V 3A-5V 3A 12.50

OIL CAPACITORS

7 MF 330 VDC \$0.95	1 MF 2000 VDC \$1.79
1.5 MF 600 VDC45	1.25 MF 2000 VDC 1.95
2 MF 600 VDC79	1 MF 2000 VDC 2.10
4 MF 600 VDC90	2 MF 2000 VDC 2.75
6 MF 600 VDC 1.05	4 MF 2000 VDC 3.95
10 MF 600 VDC 1.35	8 MF 2000 VDC 5.95
2 MF 1000 VDC 1.39	5 MF 3000 VDC 1.45
2 MF 1000 VDC 1.79	3.5 MF 3000 VDC 1.45
10 MF 1KV DC 2.75	5 MF 3000 VDC 1.49
15 MF 1KV DC 2.85	4 MF 3000 VDC 6.95
2 MF 1.5 KV DC 2.49	3 MF 4000 VDC 4.75
4 MF 1.5 KV DC 2.49	2 MF 5000 VDC 8.95
6 MF 1.5 KV DC 2.95	1 MF 7500 VDC89

TERMS: 25% Deposit with order, balance C.O.D. Rated firms open account

"SEND FOR TUBE LIST"

ATTENTION! INDUSTRIAL USERS. MANUFACTURERS, LABS., COLLEGES

Send us your specs., and let us quote—Large, Varied Stock of Tubes, Resist., Capacitors, Test Equip., etc., available.

POLY-TECH

919 Dawson St., New York 59, N. Y.
 Tel. MURRAY Hill 6-2650

further and the Commission will be forced to issue a final decision, immediately adopting the CBS color standards.

How do the manufacturers feel about this proposal? As far as could be ascertained at the time this article was written, the general consensus seems to be that even if the manufacturers did want to follow this proposal, it would be quite impossible to do so at this time. For one thing, there is an extensive shortage of parts and the proposed changes add more parts to existing sets. Secondly, there is no certainty that the change will be simple since no large scale changeover has been attempted as yet nor has there been any field testing. Finally, many manufacturers say that their top engineers are currently engaged in war work and could not be spared to do the basic developmental work. The Commission is aware of these conditions and there is reason to believe that they may be forced to give the television industry more time in which to work out the problems of adapting their present sets to the new standards.

We come finally to the television service technician, the man who will bear the brunt of the job of converting today's sets if and when CBS color is adopted. As noted, there have not been any attempted conversions within the industry as yet. However, FCC engineers have developed an automatic scanning adapter (as they call it) for a Bendix Model 235M1 television receiver. The circuit diagram is shown in Fig. 1. The dotted lines indicate the original receiver circuits of this set while the solid lines show how the additional components are connected into the circuit. The principal change in both the horizontal and vertical timing circuits is the addition of several resistors and/or condensers which are designed to change the frequency of the deflection voltages. A further addition in the horizontal output amplifier provides more voltage for this tube, enabling the circuit to produce a greater output. This increase in tube potentials is designed to raise the horizontal output voltage sufficiently to offset the decrease in

efficiency of the horizontal output transformer due to the change in line frequency from 15,750 cycles to 29,160 cycles.

In Fig. 1, the circuit will switch automatically when the signal changes. This is done by means of the auxiliary circuit shown at the bottom of the diagram. The circuit connects to the plate of the sync clipper stage within the receiver and thereby receives the incoming vertical and horizontal pulses. L_1 and C_1 are made resonant to 15,750 cycles. Whenever a black-and-white signal is received, the relay in the plate circuit of the second 6J6 is actuated and the contacts adjust the circuit to operate at the monochrome line and field frequencies by bringing the proper components into the circuit. On the other hand, when a color signal is being received, the 6J6 circuits receive little or no sync voltage and the relay contacts react accordingly.

FCC engineers itemized the cost of the additional components required to build this adapter and the cost came to \$16.34. Labor was not included. A reduction in cost can be achieved by eliminating the automatic feature of the adapter and making the switch-over manually controlled.

Can this adapter be made to fit all television receivers? Again a definite answer is not possible but it is believed, noting the similarity of the circuits in the majority of television receivers, that what will work in one set will work in the majority of sets. However, some manufacturers state flatly that some of their sets will require extensive alterations which will be possible only at the factory. It may very well be that some sets will not lend themselves to conversion but just which sets will be affected cannot be foretold at this time.

Of one thing the technician can be certain: His technical assistance will be essential no matter what color system is finally chosen. The wide-awake technician will keep himself fully informed of every new development reported in color television. The French call this "savoir-faire;" the Americans call it "know-how." In both languages it means more money in your pocket.

-30-

ORGANIZE NATIONAL FEDERATION OF TV SERVICE GROUPS

WITH the formation of new groups of service technicians, the need for a national organization to represent all such associations has been pointed out by Frank J. Moch, president of the Television Installation Service Association of Chicago.

Accordingly, Mr. Moch has organized a new national "association of associations." A charter has been obtained under the name of the Federated Television & Electronic Service Associations of America.

According to Mr. Moch, the new association program provides for representation in all of the industry's councils, furnishing of legal services to member groups, scheduling of technical training sessions, launching of a publicity campaign, the rendering of advice on

profitable business methods, the offering of proven systems and advertising helps, representation in Washington and other political centers in all matters affecting service organizations, and the publishing of an official magazine.

Mr. Moch also advises that the association will be run on a democratic basis with representation in the form of delegates to the national association from each local association. He stresses that the national organization will not in any way usurp the prerogatives of the local groups.

Headquarters will be in Chicago with regional offices on both the east and west coasts. Those interested in additional details should contact Mr. Moch at 5908 S. Troy Street, Chicago 29, Illinois.

-30-

YOUR OPPORTUNITY IS HERE NOW! LEARN

TELEVISION RIGHT AT HOME.

By the new method of **TRANSPONDENCE**

training on film and tape recordings

Now the De Forest-Sanabria Corporation—a division of the world's largest television training school—brings *class-room instruction* to you right in your own home! You actually hear your instructor's recorded voice. At the same time you watch "blackboard" size projected pictures, diagrams and illustrations. It's the quick, easy way to equip yourself for the big earnings in television—today!

LOOK . . . You get the tape recorder and projector right at the start of your course!



HEAR your instructor

It's even better than the classroom, because you can repeat the instructor's lectures until they're thoroughly understood.

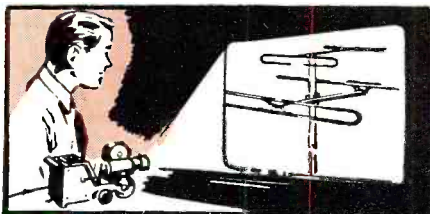

SEE 2000 illustrations

You learn quicker when you see diagrams and illustrations in black-board size.

You get the famous "TRANSPONDER" precision built, high fidelity tape recording machine with your very first lesson—and a powerful projector with which you can view diagrams and illustrations enlarged to a size that makes them easy to see and understand.



READ from reference library

You receive complete books, pamphlets and manuals to supplement your instructor's lessons.



ASK your questions on tape

Tell your instructor about anything that puzzles you and get his answers back pronto.



BE A SUCCESS . . . ACT NOW!

Millions of television set owners are demanding qualified television technicians to service their sets. There is a tremendous shortage of such qualified men today and will be for many years to come. Get in on the ground floor of this booming industry and be prepared to accept a steady, big pay job for life. We can qualify you quickly, easily, surely—and help get you a job when you complete your course. Send for illustrated booklet that gives the complete details.

MAIL COUPON TODAY!

De Forest-Sanabria Corporation **FREE BOOK**
Dept. RN-11
5050 Broadway, Chicago 40, Ill. **TELLS HOW**

Dear Sirs:
Please send me copy of your free illustrated booklet which describes the new TRANSPONDENCE method of learning television at home under the direction of Dr. Lee de Forest and U. A. Sanabria.

NAME _____ AGE _____
ADDRESS _____
CITY _____ STATE _____
(Mail in envelope or paste on a postcard.)

The De Forest-Sanabria Corp.
An affiliate of American Television, Inc.
5050 North Broadway, Chicago 40, Illinois

AGAIN... IT'S
ATLAS



Again Atlas leads the field with its new line of speakers and projectors. Again Atlas makes the news in the Sound System field.

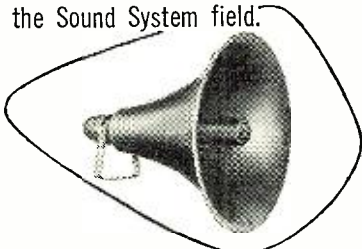

Atlas Reproducer units continue to retain the famous "Atlas V Plus" super-efficient magnetic assembly and in addition many more "Extra Plus" features. A new reversed dome, blast proof diaphragm is now standard in the high power, high fidelity models. Built-in transformers, designed for either constant 70 volt or constant impedance audio circuits are included. Improved appearance—functionally designed for maximum convenience. Double seal weather-proofing. All this and more without any general increase in price.

Atlas projectors have a new micrometrically calculated and controlled rate of expansion. Atlas non-vibrant projectors are rugged and fine in appearance. Sound energy is not dissipated in rattle vibration, distortion or cancellation.

The new improved line of Atlas speakers are really new from the voice coil to the final lock washer. It's really the "modern look" in speakers, a new high in overall performance.

Let Atlas speakers play an important part in your SOUND PROFITS.



Write for our new catalog — the most complete line of speakers, microphone stands and sound accessories.

**ATLAS
SOUND
CORPORATION**

1447 39th Street

Brooklyn 18

N. Y.

NEW TV PRODUCTS on the Market.....

TV BOOSTER

Approved *Electronic Instrument Corporation* of 142 Liberty Street, New York, New York is currently marketing the Model A-TVB television booster which has been designed for Channels 12 and 13.

The new unit, which can be used with any television receiver, is said to

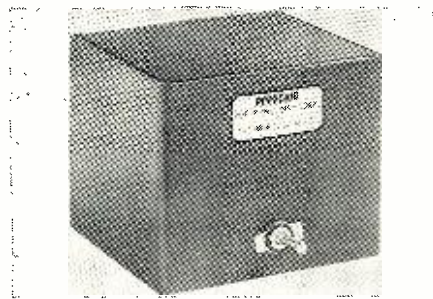

provide improved reception in fringe signal areas. The booster features a bandwidth of 15 mc., input and output impedances of 300 ohms, an electrostatically shielded power transformer, a high signal-to-noise ratio, two stagger-tuned stages which are push-pull neutralized, slug-tuned coils, two 6J6 tubes, and a long-life selenium rectifier.

The Model A-TVB is small enough to be installed in the television receiver cabinet and comes complete with tubes, operating instructions, circuit diagram, and guarantee. The unit measures 4" x 4 1/4" and weighs 3 1/2 pounds.

TV RESISTORS

A new line of high voltage resistors for television applications has been introduced by *Resistance Products Company* of 714 Race Street, Harrisburg, Pa.

Designated Type T resistors, the new units have been specially designed to withstand the high d.c., pulse, and transient voltages encountered in TV power supplies. They may be used in voltage doubler circuits and as bleeders where ordinary resistors have a limited life.

Two types are currently available.



The Type TBR is rated at 2 watts maximum at 50 degrees C ambient, 15,000 volts, 1 megohm to 10 megohms. The Type TFQ is rated at 3 watts

maximum at 50 degrees C ambient, 20,000 volts, 1 megohm to 10 megohms.

A data sheet covering these new resistors is available from the company on request.

TV/FM AMPLIFIER

Sonic Industries, Inc. of 221 West 17 Street, New York, New York has announced the addition of a TV/FM amplifier, the Model IT 5, to its line.

The amplifier is designed to provide high gain preselection for any video or FM receiver, with adequate bandwidth to pass all desired modulating elements, yet with adequate selectivity to reject unwanted off-carrier signals and noise.

Tuning is accomplished with one continuous tuning control and one "on-off" switch. The unit uses no verniers or high-low switching units. Electrical efficiencies have been obtained by means of pure silver inductances and r.f. circuit contacts, minimum shunt grid and plate circuit capacities, short input and output link wiring, optimum input and output link circuit coupling, high quality insulating elements, copper-plated chassis, and heavy power supply filtering.

The amplifier is housed in a walnut

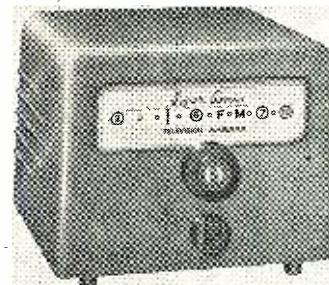

bakelite cabinet and is designed to match both 72 ohm and 300 ohm input and output circuits above the power line system.

TELEVISION BOOSTER

The "Tune-O-Matic," a new high-gain, self-tuning television booster with an all-channel broadband circuit and four-stage amplification is now being marketed by *Electro-Voice, Inc.* of Buchanan, Michigan.

The new booster may be simply and easily installed. It plugs in between the television receiver and the electric outlet and is turned on or off automatically by the TV receiver switch.

Automatically tuned for all channels, 2 through 13, the new booster instantly supplies extra signal strength uniformly throughout any channel selected on the TV receiver dial. It is not necessary to switch from low to high bands. Regulation of gain is made by turning the receiver contrast

"Premier" Values on PARTS and TUBES

Output Transformers

STANDARD REPLACEMENT

For 50L6, 35L6, 50A5, 35A5, 117L7. **47c ea.**
For 6V6, 6F6, 3Q5, 3Q4, 35A, 3V4, 41, 42, 6K6, 2A3, 45, 6L6. **54c ea.**



UNIVERSAL OUTPUT TRANSFORMERS SPECIAL

Up to 12 watts to any speaker (while they last) **\$1.18**

World's Best Indoor TV Antenna

A beautiful antenna which is the ultimate in reception, highest signal gain, nothing to adjust.

List Price \$12.00. Each **\$4.78**

TV Antennas:

Hi-Low Conical with 8-ft. mast **\$5.94**

World's Best Deluxe Conical

with 9-ft. mast and heavy cast fittings **10.74**
Hi-Low folded dipole array, 8-ft. mast **8.34**
Ballast Tubes for AC-DC TV Sets **ea. .60**
TV Discriminator Transformers **ea. .83**
TV Screen Filters with suction cups—best quality INDIVIDUALLY BOXED for highest re-sale value **10" 1.40**
12" 2.34
16" 3.06

VOLUME CONTROLS

VERY BEST BRANDS 10 or more Each Price Each
1/2 meg. or 1 meg. or 1 1/10 meg. with switch—long shaft **35c 42c**
2 meg. for battery sets—switch, long shaft **35c 42c**
1/2 meg., 1 meg., 1 1/10 meg. or 2 meg., long shaft, less switch **19c 23c**
1000 ohm **19c 23c**
5000 ohm **19c 23c**
1/2 meg. with 6" shaft **59c 71c**

Oscillator Coils for any 5-tube AC-DC **23c**

Standard replacement crystal cartridge L70-L72 **\$1.96**
NYLON 1J CARTRIDGE **\$2.59**

IF TRANSFORMERS

Standard Replacement Regular size 455 Kc. **ea. 35c**
Midget 455Kc. **ea. 47c**

FILTER CONDENSERS

Very best brands. Fresh stock



450 Working Volts

8-450 V. **ea. 29c**
10-450 V. **ea. 35c**
20-450 V. **ea. 47c**
30-450 V. **ea. 59c**
30-450 V w/ 20-20-25 V. **ea. 35c**
10-10-450 V. **ea. 52c**
20-20-450 V. **ea. 59c**
10-10-10-20-450 V-150-25 V. **ea. 59c**
30-30-400 V-350 V. **ea. 47c**
30-30-25-400 V-25 V. **ea. 47c**

150 Working Volts

8-150 V. **ea. 23c**
8-8-150 V. **ea. 23c**
10-150 V. **ea. 23c**
10-10-150 V. **ea. 29c**
10-10-10-150 V. **ea. 35c**
15-150 V. **ea. 25c**
20-150 V. **ea. 30c**
30-150 V. **ea. 35c**
40-150 V. **ea. 35c**
15-15-150 V. **ea. 35c**
20-10-150 V. **ea. 35c**
20-20-150 V. **ea. 35c**
30-20-150 V. **ea. 47c**
30-30-150 V. **ea. 47c**
35-35-150 V. **ea. 47c**
40-20-150 V. **ea. 47c**
40-40-150 V. **ea. 47c**

40-40-150 V

20-25 V. **ea. 47c**
50-30-150 V. **ea. 47c**
20-16-16-350 V. **ea. 47c**
Sprague type **ea. 47c**
25-25-150 V-200-10 V. **ea. 47c**
15-15-40-20-150 V-25 V. **ea. 35c**
20-20-150 V-25 V. **ea. 47c**
30-30-200-150 V-10 V. **ea. 47c**
20-16-16-150 V. **ea. 47c**

Cathode Condensers

10-25 V. **19c**
20-20-25 V. **ea.**
20-20-20-25 V. **ea.**
30-50 V. **ea.**
100-25 V. **29c ea.**

SPEAKERS

Best Quality Alnico 5 PM

10 or more Each Price Each
2 1/2", 3", 4", 5" **114 126**
8" **\$2.94 53.23**
10" **4.74 5.10**
12" **5.94 6.54**
SPECIAL—6" PM Speakers, big Alnico 5 magnet, in lots of 10, each **\$1.55**
individual **1.67**



SPECIAL-CONDENSER KITS

Kit of 50 BY-PASS CONDENSERS very best, assorted sizes **\$1.98**
SELENIUM RECTIFIERS Standard 100 mil. Ea. **95c**

Special on No. 47, 44 and 51 100 Pilot Lights **\$4.74**
Box of 10 **59c**

PILOT LIGHTS—100 Bulbs **\$5.88**
Box of 10 Bulbs **65c**
No. 40 No. 41 No. 46

OCTAL SOCKETS

MOLDED. 10 for **59c**
7-PIN MINIATURE SOCKETS **10 for 59c**
9-Pin Miniature Sockets **10 for 59c**
Octal Sockets **10 for 59c**

300 ohm twin lead **\$29.00**
1000 ft. rolls **\$3.25**
100 ft. rolls

BY-PASS CONDENSERS

100 Condensers assorted in package **\$7.14**
.001 6c .0005
.002 6c .00025
.005 6c .0005
.01 8c 500 mmf **7c**
.02 8c 250 mmf **600 V.**
.05 10c 100 mmf
.1 11c 50 mmf

BY-PASS SPECIAL—SOLAR

In lots of 25 or more **ea. 11c**
.25 mfd. 600 V. **Less than 25 ea. 14c**

400-VOLT BY-PASS CONDENSERS

.05 mfd. **ea. 7c**
.2 mfd. **ea. 7c**
.25 mfd. **ea. 12c**
.5 mfd. **ea. 18c**

BUFFER CONDENSERS

.005 mfd. 1600 WV **ea. 18c**
.008 mfd. 1600 WV
.01 mfd. 1600 WV

VARIABLE CONDENSERS

Two-gang for superhet or TRF **ea. 83c**

RED HOT VIBRATOR SPECIAL!

Standard small size, 2 1/4" in height (the popular small size), bright and shiny. **\$1.29**
Stock up while they last, all 4-prong each Universal Vibrators.

6-FT. LINE CORDS
Good Rubber with Underwriters' Approved. **\$1.50**
10 for **\$2.03**

SPECIALS

10BP4 .. \$14.95	12LP4 .. \$19.95	14BP4 .. \$22.95	16RP4 .. \$29.95	16TP4 .. \$29.95
39c ea. 1S5 10 2C26 12A 2C34 39/44 3A4 47 01A 50 6A3 71A	112A 1A4 182B 1A4P 183 1A6 255 1B5 482B 1D5GT 483 1D7	1D8GT 1H4G 1F4 1H6GT 1F5G 1J6G 1G4GT 1619 1G6GT 1626	69c ea. 1T4 25Z6GT 35 5Y3GT 30 35Z4GT 35W4 31 36 35Z5GT 32 37 6C4 33 38 6X5GT 34 46	VT-52 89 HY-615
89c ea. 1C5 3Q4 1C6 354 1L4 3V4 1R5 5W4GT 1U4 5X4G 1U5 5Y4G 2A5 6A8A 2A7 6AC4 3Q4 6A8G 354 6A8T 3V4 6A8T 5W4GT 6A8T 5X4G 6A8T 5Y4G 6A8T 6A8A 6A8T 6AC4 6A8T 6AC5GT 6B6 6A5 6BA6 6A6 6BD6 6A7 6BE6	6AQ5 6AQ6 6AR5 6AS5 6AT6 6A8T 6AU6 6B6 6B8T 6BA6 6B6 6BD6 6B7 6BE6	6BH6 6K7GT 6BJ6 6K8GT 6C5 6L5 6C8G 6S4 6D6 6SA7GT 6F5GT 6SC7GT 6F6GT 6SG7GT 6G6 6SH7 6H6GT 6SJ7GT 6J5GT 6SK7GT 6J7GT	6SQT 6SR7 6U6GT 6U7 6V6GT 6W4 6W4 6X4 6Z4 6Z4 12A8GT 12A8T 12AT6 12AT6 12AU6 12AU6	12AX7 12SH7GT 35Z6GT 12BA6 12SR7GT 50B5 12BE6 1629 (eye) 50C5 12F5GT 24A 50Y6 12H6 25L6GT 51 12J5GT 25W4GT 77 12J7GT 25X6 78 12K7GT 26 85 12K8GT 27 99 12SF5 35B5 12SF7 35C5
98c ea. OZ4 1A7GT 1A5GT 1C5GT	1C7G 5V4 1LA4 5Z3 1LE3 5Z4 1Q5GT 6A8 1T5GT 6AC7 1V 6AJ5 2B7 6AK6 1A7GT 6D8G 1C5GT 5U4G 6AL5	6AV6 6J6 6B4G 6K5 6BA7 6P5GT 6B8 6R7 6C6 6S5GT 6CB6 6SF5GT 6D8G 6SL7GT 6F8G 6SN7GT	7A6 6S57 7A7 6S7 7B5 6Q7GT 7B6 6I7G 7B8 6W7G 7C4 6Y6G 7C6 6Z7G 7E5 7A4	7E6 7Q7 7E7 7S7 7F7 7T7 7G7 7V7 7H7 7W7 7J7 7Y4 7L7 12A7 7N7 12AT7
\$ 10 ea. 1A3 1L5C 1AB5 1L6 1H5GT 1N5GT 1LA6 1LH4 1LB4 1LN5	1C5 1N5GT 1L6 1P5GT 1L5 1S4 1LH4 2V3G 1LN5 2X2	3LF4 6J8G 4A6G 657G 6B7 6SU7GT 6BF6 6T8	7A8 7A8 7C5 7C5 12A6 12A6 12BF6 12BF6	14A4 14B6 14A5 14B8 14A7 14E6 14A7 14E7 14A7 14W7
\$ 1 25 ea. 1B3GT 2A4 1X2 3Q5 2A3 6A7	6AK5 6G5 6BQ6GT 6L6G 6E5 6SD7GT	6U5 70L7GT 32L7GT 350B 50A5 807	\$ 1 35 ea. 6B5 6BN6 12BN6 25AC5GT 25BQ6GT	117L7GT 117P7GT 117Q7GT
\$ 1 79 ea. 6BG6G 19BG6G	35Z3 81 45 83 2050 117Z6GT 2051 9001 50C6 9001 50C6 9001	35Z3 81 45 83 2050 117Z6GT 2051 9001 50C6 9001	35Z3 81 45 83 2050 117Z6GT 2051 9001 50C6 9001	35Z3 81 45 83 2050 117Z6GT 2051 9001 50C6 9001

Less than 50 tubes, 5c per tube extra.
Tube prices are for 50 tubes or more—may be assorted.
Individually boxed—Standard factory guarantee.

PREMIER RADIO TUBE COMPANY
551 West Randolph St., Chicago 6, Ill.
Phone: Andover 3-1590
"Your Tube Source Since 1926"

20% deposit with order, balance COD. \$1.00 handling charge for orders less than \$5.00. All shipments FOB Chicago. Our parts and tubes are warranted to be 100% replacements for the prototypes in the listings above. Satisfaction Guaranteed. Illinois residents add 2% sales tax.

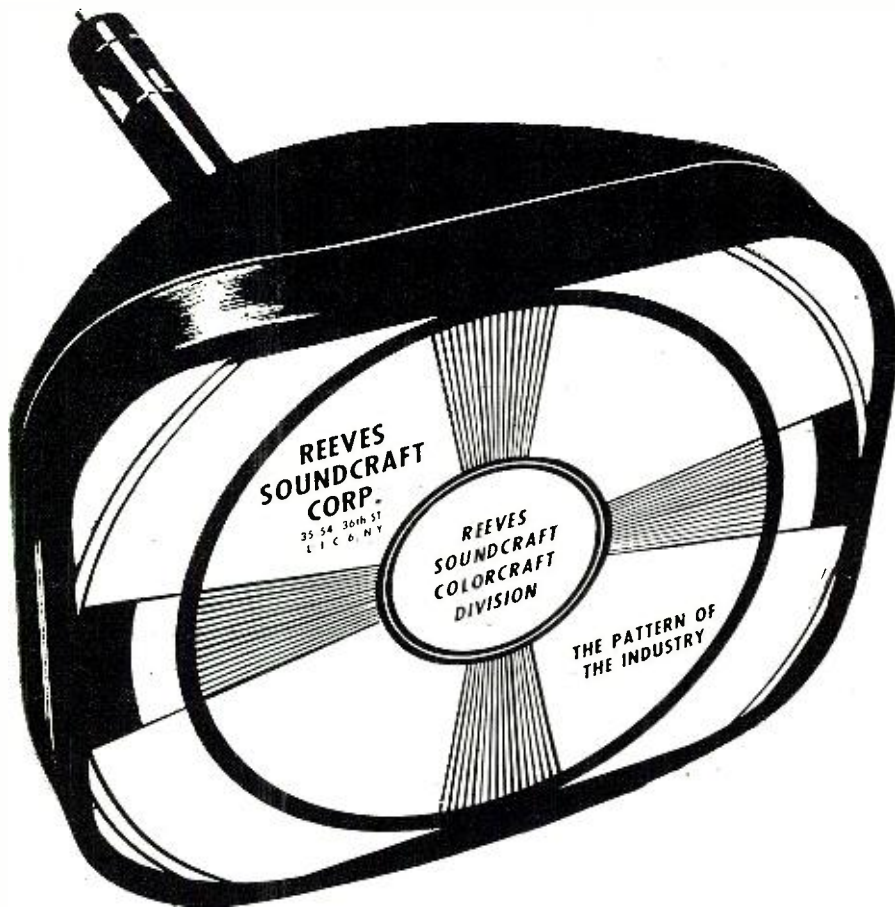

control. No need to retune after the booster warm-up period as signal drift is eliminated.

The four-stage amplification completely isolates the receiver local os-



cillator and effectively eliminates re-radiation which causes interference to nearby TV sets.

Full information on the new booster is available from the company on request.

COMPASS POINT INDICATOR

U. S. Devices Corporation of Hillside Ave-Oaktree, South Plainfield, New Jersey has a new compass point indicator available for the TV market.

This new unit features a full 360 degree dial which is said to be four times larger and clearer than any other similar indicator currently available. The indicator shows the exact position of the antenna at all times whether the antenna is in motion or stopped. It features a simple mechanism which is foolproof and impervious to varying line voltage.

The rotator features a 3/4" steel shaft which rotates on a case-hardened steel ball, in-line ream oilless bearings keep



the shaft in line at all times. The unit is capable of rotating an antenna weighing as much as 1000 pounds.

Complete data on the new indicator is available from the company on request.

HAYDU ROTATOR

Haydu Brothers of Plainfield, New Jersey is currently in production on a new antenna rotator which has been developed after many months of engineering and experimentation.

The new rotator operates from the chairside through a remote control cabinet connected to the motor unit by a three-conductor cable. Rotation is accomplished by pressing either of two buttons, for turning either right or left. Releasing the button instantly stops rotation without coasting and locks reception in that precise posi-

RADIO & TELEVISION NEWS

SAVE BATTERY RENEWAL COSTS CONVERT BATTERY RADIOS TO AC ALL-ELECTRIC

Now is the time to change your dry battery radio into a dependable hum-free AC receiver with an Electro Battery Eliminator. Eliminates batteries, high operating costs, uses only 11 watts. Fits most radios, easily slips into battery space. Operates 1.4 volt, 4, 5, or 6 tube battery radio from 115 volt, 50 to 60 cycle source. Has selenium rectifier. Guaranteed three years.



NEW

Model "S" Battery Eliminator

Also available for 220 volt operation

ELECTRO PRODUCTS LABORATORIES

4509-S Ravenswood Ave., Chicago 40, Ill.

Send me FREE literature and name of nearest source.

Name _____

Address _____

City _____ State _____



Pioneer Manufacturers of Battery Eliminators

Telex Twinset

CAA

APPROVED



Yes sir, it's a fact! Telex Twinsets are C.A.A. approved. Actually, you won't know how light a headset can be until you try a Twinset. There's no pressure on the ears whatsoever, yet all background noise is blocked out.

The Twinset weighs only 1.6 ounces, completely eliminates fatigue and discomfort.

Write for free folder on the Twinset today . . . or see your Parts Jobber.

TELEX

Dept. H-21-10

TELEX PARK

ST. PAUL, MINN.

In Canada, ATLAS RADIO CORP., TORONTO

Standard of the World for Quality Headsets

OUTSTANDING VALUES NOW AVAILABLE

G I—13-CHANNEL TELEVISION TUNER

For replacement or construction work. Capacity type tuner with fine tuning control. Using 3—6J6 tubes. Input for 300-ohm line. One of the finest front ends ever built.

Each.....\$6.95 less tubes
Lots of 3..... 6.50 each

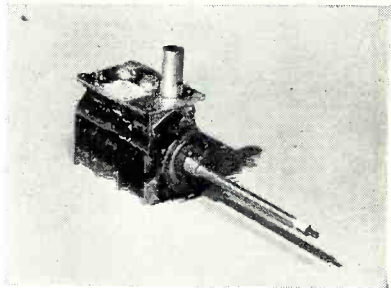

VOLUME CONTROL STEAL

250,000 } With switch—2 1/2" milled shaft
500,000 } 39c ea.
1 meg. } Lots of 10.....\$3.72
2 meg. } Asst. of 25..... 8.74

Standard Type Replacement Phono Cartridge

All New—All Guaranteed

Type No. 1 will replace Shure W58A
Webster N10
Astatic L70

Price—only \$1.85 ea. Lots of 10 \$17.90

Type No. 2 will replace Shure W56A
Webster N10
Astatic L-72

Price—only \$1.99 ea. Lots of 10 \$18.90

CERAMICON CONDENSERS

Standard Manufacture

Kit of 100 most often used ceramic—now only.....\$4.95

GT TUBE CARTONS

Sturdy—Many Uses.

Box bulk tubes, spare parts, nuts and bolts.
\$.79 per 100
4.95 per 1000

KNOB ASSORTMENT

Includes half push on and half set screw knobs. All used often.

100 knobs only.....\$1.89

PM REPLACEMENT SPEAKERS ALL NEW—ALL GUARANTEED

4" Alnico V.....\$1.19 ea.
5" Alnico V..... 1.29 ea.
6" Pin Cushion Alnico V..... 1.69 ea.
6" Round Alnico V..... 1.69 ea.
4x6" PM Alnico V..... 1.59 ea.
7" PM Pin Cushion Heavy Alnico V
Offset holes for auto replacement. 2.29 ea.
6x9" PM Heavy Alnico V..... 2.29 ea.
8" PM Heavy Alnico V..... 3.25 ea.
10" PM Heavy Alnico V..... 3.95 ea.
12" PM Heavy Alnico V..... 5.25 ea.

NOW! LARGE 14" or 16" PICTURE FROM YOUR 10" or 12" TELEVISION SET

Servicemen: Convert customers' sets for extra profits! 90% of all conversions can be made by use of the RAPARCO conversion kit.

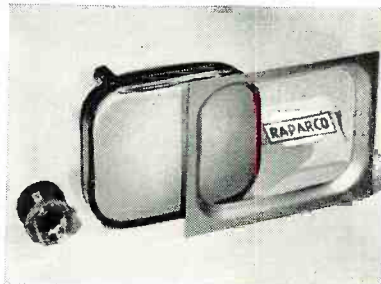

Includes 14BP4 CR tube, 70° deflection yokes, and attractive lucite mask.

Complete, only.....\$32.95

HIGHEST QUALITY TELEVISION COMPONENTS AT LOWEST PRICES YET!

Standard Manufacture—All New—All Guaranteed. All these parts are used constantly in repair or conversion work.

70° Deflection yoke—includes leads and resistors.....\$3.50 ea.
60° Deflection yoke..... 2.25 ea.
Flyback transformer for 12 1/2" set.. 2.75 ea.
Flyback transformer for 16" set.... 3.50 ea.
14" Attractive Lucite Square Mask.. 3.95 ea.
16" Attractive Lucite Square Mask.. 4.50 ea.
14BP4 Square, Black 14" CR tube..25.95 ea.
16TP4 or 16XP4 Square Black 16" CR tube.....37.50 ea.

INDOOR TELEVISION ANTENNA



Now TV reception without the outdoor antenna. Effective range 20 to 25 miles from station. Excellent reception. Easily installed—takes 5 seconds. Easily orientated. Heavy base—will not tilt. Attractive. Friction clutch-type action on the rods.

Complete with lead in.....\$1.99

CRESCENT CHANGERS for the RCA 45-R.P.M. System

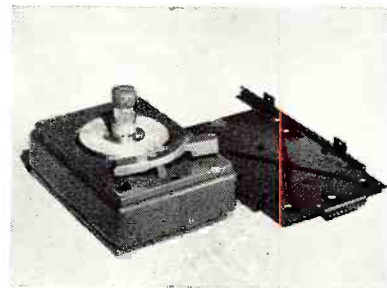

A complete changer ready for installation or attachment. Beautiful in appearance, built to last under constant service.

Each changer comes complete with Crescent "Rollway" mounting for custom installations.

Price complete.....\$8.59

Metal Base for RCA 45 R.P.M. changer—Mahogany Hammerloid Finish.\$1.00

SUPER 25 WATT HI-FI AMPLIFIER KIT



Including all parts, schematic and layout diagrams, enabling you to easily build this fine, deluxe amplifier.

FEATURES:

- Ready punched chassis
- Multi-impedance output transformer 2-4-8-16-500 ohms for use with any PM speaker
- 2 mike inputs, 1 phono input
- Push pull phase inverter driver for low hum and distortion
- Hum level 65 DB below rated output
- Separate bass and treble control
- 110-120 volt AC operation, on fuse UL approved line cord
- 6 tubes: 2—6SJ7, 6SC7, 2—6L6G, 5Y3
- Attractive, well-constructed steel chassis and cover. Baked hammerloid finish
- Indirect lighted panel
- Frequency Response 20-17000

Nowhere can an amplifier of comparable features be had for twice the price. This amplifier, designed from the famous Clark Amplifier, will fill 90% of all sound uses.

\$25.95 COMPLETE WITH TUBES

Radio Parts Company, 614 RANDOLPH ST., CHICAGO 6, ILL.

Columbia

GEN OF THE SURPLUS

ARC-5 OR 274-N TRANSMITTERS COMPLETE	
2-13 mcs. Excel. for ship use.....	\$10.95
3-4 mcs. Used, excel. cond.....	10.95
4-5.3 mcs. Used, excel. cond.....	3.50
5-9.7 mcs. Used, excel. cond.....	3.50
7-9.1 mcs. Used, excel. cond.....	9.95
ARC-5 OR 274-N RECEIVERS	
1-5.3 mcs. For ship use. Excel. cond.....	\$14.50
3.6 mcs., excel. cond.....	6.95
6-9.1 mcs., good cond.....	9.95
190-550 kcs., excel. cond.....	9.95
Command Receiver flex. cable.....	.79
Command Receiver 28V dynamotor.....	.69
Command K'nob for Receiver, Ea.....	.79
MP7/ARC-5 Plate Modulator.....	1.95
BC-45B Screen Diode.....	1.95

274N ANTENNA RELAY BOX	
Contains RF meter plus 50 mfd H. V. vacuum cond. and relay. New in carton.....	
\$2.25	
A5B-3 500-550 MC RECEIVER: Easily converted to citizens' band or 290 mc. ham band. Less tubes. Excel. cond.....	
\$7.50	
BC1068 RECEIVER: 110 V. 60 cyc. Freq. range 150-210 mc. or higher. 2-tuned R.F. stages, tune converter & oscillator, 5 I. F. stages with iron-core I.F. Excel. cond. Terrific buy.....	
\$24.50	
MK-20-UP PRESSURIZING HAND PUMP: Used to furnish dry air in wave guides. Compl. with pressure meter and hose. NEW.....	
\$22.50	
RL42A ANTENNA REEL ASSEMBLY: Excel. for rotating, small beam. Less wire. NEW IN ORIG. BOX.....	
\$5.50	
MG-19A AMPLIDYNE: New. Excel. cond.....	
\$125.00	

SELSYN MOTORS
115 V. 60 cycles. Terrific for beam indicators. etc. Good cond. PER PAIR..... \$7.95

PE103 DYNAMOTOR
6 and 12 V. input; output, 500 V. @ 160 mils. Ideal for mobile. Excel. cond..... \$15.95
PE104 WIGTOR POWER SUPPLY: For BC634. Input 6 or 12 V. Output, 51 V. neg. bias. 90 V. B. plus @ 5-10 mils. 1 1/2 V. filament @ 350 mils. Excel. cond..... \$7.50

LOOPS! LOOK! LOOPS!
MN-20-E for MN-26 and RA-10, etc. New, boxed, Ea. \$ 7.95
DU1 MDF Has 2-tube amplifier. New, boxed 24.95
MN-24C CAA approved. Good cond. 24.95
LP-21A for ADP. Excel. cond. 7.95

SELENIUM RECTIFIER
Fine for 24V. @ 3 amp. and surplus equipment. Only \$23.39

CONDENSERS
10 mfd. @ 600 V. New..... \$.99
3 mfd @ 1500 V. W.E. New..... 1.29
W.E. No. 188-A Seven different condensers in one can from .1-.0015. 3 CANS FOR 1.29
GE RELUCTANCE PICK-UP CARTRIDGE: For turntable. NEW..... 1.95

TRANSFORMERS
Filament: 5V. @ 10 amps for 82 tube. 60 cycles, with socket. Good cond..... \$6.95
Filament: 5.1 V. @ 190 amps. Ideal for spot welding. Good used cond..... \$24.95
Peerless Matching Xfmrs: 50-500 or 500-50. Brand new and boxed..... \$1.49
TRANSFORMER: 3200 V. @ 200 mil; a pair good for kw. EACH..... \$9.00
SPECIAL PER PAIR..... \$17.50

TV TUNER
13-channel turret with 6CH6 RF amplifier and 6J6 oscillator mixer. Has silver contacts, 3/4 in. shaft, conical vernier control. All tubes and parts factory connected and aligned. Standard video and audio output. See June '50 RADIO NEWS, P. 58.
New, late model..... \$19.95
Conical TV antenna. New..... 4.95
Arrow TV antenna. New..... 7.50
New 300 ohm lead-in wire..... 2.50
TV IF STRIP with peaking coils. NEW..... 9.95

BC-222 WALKIE-TALKIE
Freq. range 28-38 and 38-52 mc. Operating range: up to 50 miles. Complete transmitter with handset, batteries, antenna and spare tubes. Ready to operate. EACH \$ 55.00
Fair 100.00

FL8A FILTER
For reducing noisy QRM. Will pass signals of 1220 c.p.s. Brand new..... \$1.95

GIANT FEED THRU PORCELAIN INSULATORS
New. Boxed. Each..... \$3.95

PORTABLE ELECTRONIC MEGAPHONE
Dry battery operated. Brand new. Amplifier and megaphone complete..... \$25.00

MICRO SWITCHES
New, boxed. Each..... .29c

BC375 TRANSMITTER
100 W. Ideal for marine or ham use. Freq. 200 kc. to 12 1/2 mc. depending on tuning unit. Excellent condition..... \$12.95

ALL-PURPOSE TUBES			
725A	\$ 4.95	715C	\$14.95
708A	3.95	705A	1.00
713A	1.00	722A	1.95
JRC359	1.25	707A	9.95
531	3.95	701	7.50
307A	2.95	2102	2.95
706PY	29.50	5B	6.50
715A	4.95	WE700C	12.50

COLUMBIA ELECTRONIC SALES
522 South San Pedro Street
LOS ANGELES 13, CALIFORNIA

tion. A signal light is included in the circuit hook-up and glows brightly to indicate the completion of each revolution.

Other features of the new unit include a permanently weather-sealed cast aluminum housing which will withstand pressure up to 33,000 pounds per square inch, a self-protecting feature that prevents accidental damage to the unit through improper operation, operation from any 110 volt a.c. wall outlet, and the use of Barber-Coleman gears throughout.

MASCO BOOSTER

Mark Simpson Mfg. Co., Inc. of 32-28 49th Street, Long Island City, N. Y. has announced a new television booster, the Masco "Sky Chief."

The new booster is designed for use in areas of low signal strength and to help reduce noise and interference from diathermy, auto ignition, radio and TV sets, amateur transmitters,



and FM stations. It is also said to aid in eliminating ghost images and in reducing snow.

The unit is housed in a baked mahogany metal cabinet with a sloping dial panel. Its one tuning control covers from Channel 2 to Channel 13. It turns itself on with the TV receiver and "stands by" when its additional signal strength is not required.

ROOF MOUNT

Of interest to television installation men is the announcement by Channel Master Corp. of Ellenville, New York of a new "All-Angle Peak Mount."

According to the company, the new mount solves all roof mounting problems inasmuch as it will fit all kinds of roofs. It will fasten securely on flat roofs, level or sloping, and peaked roofs of any angle or pitch. Firmly gripped by a rigid U-bolt clamp in the unit's serrated nest, the antenna mast cannot turn even in the strongest winds.

The Model 9015 is a heavy-duty unit, consisting of three massive castings of hard-temper aluminum, alloy 319. It cannot rust or corrode. The mount will accommodate masts from 1" o.d. to 2" o.d.

This new roof mount, as well as the company's other TV accessories, is completely described in a new accessory catalogue which is available on request.

Leotone

!!Midget Mike-Speaker Unit!!
(.00 1/2" sq. x 1 1/2" High) Excel.
Lo-imped. Mike, Phone, Pil-
low Speaker, ea. 59c 4/2.00
Steel Mesh Sections.
MS-53 or MS-54..... .39

- "Alnico Magnet" Assortment... Powerful Bar, Block, "U", Ring. Kit of 10 assorted..... 1.98
- (Write for Latest "Alnico Magnet" Supplement)
- 3" Shaft Extensions 1/4" - 1/4"..... 23c 5/1.00
- Fahnestock Clips . . . 3/4" brass..... 1.00/89c
- HB-30 Headbands . . . adjustable for HS-30 15c 6/1.00
- 3-1/2" Brown Linen Baskets 7"x10" - 65c;
- 7"x14" - 85c 7"x18" - \$1.05 9"x15 1/2" - \$1.15
- Push-Button Station Tabs . . . full set . . . All U.S. . . . 39
- Seismic Relay FW Bridge, 18VAC .6A..... .98
- 1/2" Red Jewel Assy & min. bay. bulb. .29c 4/1.00

Midget Outputs (3/4" sq. x 1 1/2") for 50B5, etc. 49c 5/1.98

Midget Audio Chokes (3/4" x 1 1/2"), 4500 ohm DC 49c 5 1.98

DPDT Antenna Relay . . . 12VDC; 3A. cont. 1 1/2" x 2"59

SPST Alliance Relay "CNSX" 1 1/4" D.C. N.O.59

DPDT Toggles (C-H) 20A/125V. Spring return. . . .39

1 1/2" Audio Transformer (Cardwell) 1 1/2" sq. x 2" . . .69

DM-26 Dynamotor . . . 24VDC to 220V. 80mm. . . .98

Lid Supports (Poly Hinge) for Consoles, Chests. . . .49

Auto Suppressors - universal elbow type 9c 15/1.00

W-110 Army Field Wire . . . rolls 150-300 ft. 1/2c ft.

Radio Hardware Treasures - Full Pound Can of Nuts, Screws, Washers, Lugs, etc. 10/79c

Rubber Line Plugs - heavy duty 9c 10/79c

TU-17 Tuning Unit (BC-223). Gold Wire of Parts98

2" Round Meter Case & Glass . . . 1 1/2" deep..... .39

RG-13 CO-AX . . . 74 ohm, 20 ft. lgths, 2 conn. . . .2.49

TU-17 Tuning Unit (BC-223). Gold Wire of Parts98

Amplifier Chassis & Cover - punched 5 tubes. Chromium plated. Overall: 11" x 9 1/2" x 4 3/8" 1.29

Grille Cloth - 12" x 17". Rich mahogany. 49c 5/1.98

Frequency Meter Tech. Manual . . . FS-173, 58 pp. . . .25

.05-.600V. Oil Condensers..... .9c; 13/1.00

!!Colossal!! - 17 Lb. Jumbo Radio Parts, Kit..... 1.98

Load With: Coils, Hardware, Speaker Accessories, Wire, Resistors, Condensers, etc..... 2.95

Moulded Bakelite Condensers, Micromold, .00001 to .2mfd. 200-600V. Kit of 90 asstd. 1.98

HS-33 Headset . . . Lo-imped. 5 ft. cord, PL-55..... 1.69

P-23 Headset . . . Hi-imped. 5 ft. cord, PL-55..... 1.69

Rubber Phone Cushions..... pair69

Double Headset Cord . . . rubber, tipped..... .49

Headset Extension Cord . . . JK-26 PL-55. 6'..... .98

Aluminum Panels (OEI) 7"x18" 69c; 11 1/2"x18"98

High Fidelity Crystal Mike. Hi-imped., rubber shock mtd. O.D. 1 3/4" x 1/4". Less case..... .15

Aluminum Housing for crystal mike..... .98

Rubber Shock Mounts . . . 8 lb., 1" Mtg. 12c; 10/1.00

Tube Cartons . . . Plain white (prices per 100):

Miniature (1 1/2" sq. x 2 1/2") 1.20; 6T 1 1/2"x1 1/2"98

Large (2" sq. x 5") 1.98

Dial Scales . . . 3 1/2", Acetate, glass, 25 asstd. . . . 2.49

Dial Escutcheons . . . sp. Round, sliderite, 25 asstd. . . . 2.49

Dial Windows . . . Glass & acetate. Kit 12 asstd. 1.29

Knobs . . . screw & spring. Kit of 25 asstd. 98

FACTORY SPEAKER REPAIRS SINCE 1927

Min. Orders \$2.00. 20% deposit on all COD's
Full Remittance with foreign orders
Please add sufficient postage-excess refunded

LEOTONE RADIO CO.
65 Day Street
New York 7, N.Y.

CHICAGO

RADIO AND APPLIANCE MULTITESTER

Model 458A

New Wider Ranges

NEW CASE DESIGN FOR EASY READING

AC and DC VOLTS: 0-2.5/10/50/250/1000/5000
AC AMPS: 0-0.5/1/5/10 DC AMPS: 0-1/10
AC and DC MILS: 0-1/10/100
OHMS FULL SCALE: 1000/200,000/2,000,000
OHMS CENTER SCALE: 50/2250/22,500
SIZE OVERALL: 10 1/2" x 6 1/2" x 6" Meter: 4 1/2" wide.

Handsome brown Hammerloid case with leather strap.
1000 Ohms per volt. Net Price \$26.00

We manufacture a complete line of fine portable multimeters.

Chicago

Write for circular

INDUSTRIAL INSTRUMENT CO.
536 W. ELM ST. • CHICAGO 10, ILL.

Record-Reproduce

(Continued from page 43)

ance of the equalizer (15,000 ohms) to a line impedance of 600 ohms.

The AE-2 unit was panel mounted and may be seen in the photo directly above the jack fields.

Line Amplifier and Bridging Bus

The purpose of a line amplifier is to take a relatively low level signal and bring it up to a suitable level for transmission through a line. The output level of the line amplifier must be sufficiently high so that it may override any noise which is induced in the transmission line. Normally, a suitable figure for this output is plus 4 dbm.

The line amplifier employed in this system raises the input level of approximately minus 30 dbm. to an output level of plus 4 dbm. The over-all gain therefore must be at least 34 db. The design of this line amplifier is conventional and will be treated more fully in later chapters. The output or secondary side of the line amplifier terminates in a low impedance bridging bus.

The bridging bus is a transmission line terminated by a suitable resistor. The function of the bridging bus is to act as a distribution point from which the audio signal may be fed to several other circuits, including bridging amplifiers, metering circuits, monitor amplifiers, recording amplifiers, and long lines. The bridging bus is a low impedance circuit of 600 ohms. The line amplifier therefore works between two low impedances.

The Jack Field

The jack field comprises two panels, namely the ADC PJ143 and a PJ141 jack panel. The jack field is really the heart of our system and all input and output circuits terminate in one or the other of the jack strips. Provisions are made for direct connection of the phono pickups, microphones, detector circuits, bridging circuits, monitoring circuits, metering circuits, amplifier circuits, and speaker circuits. It is extremely important when laying out a jack field that all circuits having a difference in level of approximately 20 db. be widely separated in order to prevent crosstalk. This is accomplished by positioning all low level sources remote from output power from the amplifiers. The design of the jack field probably receives the greatest amount of attention in a system such as this. All wiring and cabling must be done with extreme care in order to avoid ground loops. Complete details on the construction of a jack field will appear in later chapters. Suffice it to say that, being of prime importance, it should receive careful consideration.

Recording-Playback Amplifier

Inasmuch as we engage in a considerable amount of disc recording, it was

BECOME AN ELECTRONIC TECHNICIAN IN 12 MONTHS

TRAIN NOW FOR IMPORTANT RESPONSIBILITIES

Do you have 12 months to invest in a training program that can bring immediate and life-long opportunities?

Then investigate the Technician courses available at this College of Electrical Engineering. For example, in those valuable 12 months you can earn your Electronic Technician's Certificate. You enter the fascinating field of Industrial Electronics. You are trained for responsibilities of tremendous growing importance to the strength and welfare of the nation.

This world-famous course also supplies the basic fundamentals so that you can progress into studies of radar, television and other branches of Communication Electronics.

- Over 35,000 alumni and 1,555 students • Faculty of 85 specialists
- Train in modern, well-equipped shops.



MILWAUKEE SCHOOL of ENGINEERING

Technical Institute • College of Electrical Engineering



A SPECIAL PREPARATORY program is offered.

MILITARY, ACADEMIC OR PRACTICAL training will be evaluated for advanced credit.

NEXT TERMS OPEN
JANUARY 8 . . . APRIL 2

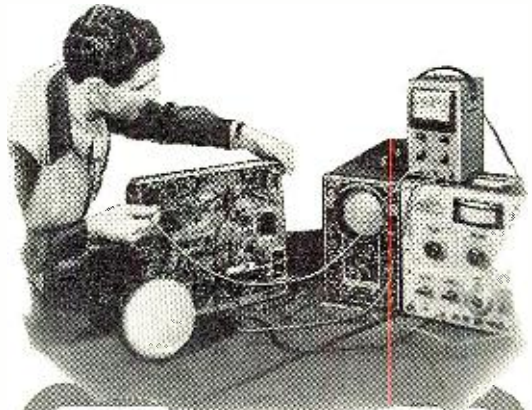

6 additional months make you a RADIO-TELEVISION TECHNICIAN

It is academically possible for the Electronic Technician to complete this course in 6 months of study. You are then ready for vital assignments in the fields of Communication Electronics.

TV and other branches of advanced Electronics requires men who are trained under the daily, personal guidance of specialists — through an intensive course such as offered here.

In 24 additional months become an ELECTRICAL ENGINEER

Under this internationally-known educational system, the Technician courses described here are complete in themselves but also serve as units of the College program leading to the B.S. degree with a Major in Electronics. Thus, if you must leave school after completing your Technician course, you are ready for immediate employment or specialized services. Or, you can continue here immediately or at any time and your Technician Course will be credited toward your B.S. degree.



Write today for the helpful "Combination Catalog and Occupational Guidance Manual".

MILWAUKEE SCHOOL OF ENGINEERING
Dept. RN-1150, N. Broadway and E. State
Milwaukee, Wis.

Rush free "Combination Catalog and Occupational Guidance Manual" plus facts on course in.....

Name.....

Address.....City.....State.....

Check if Veteran of World War II

EXTRA!

ATR

"A" BATTERY ELIMINATORS

Makes it easy to **DEMONSTRATE AND TEST D.C. APPARATUS FROM A.C. LINES**

for DEMONSTRATING AND TESTING AUTO RADIOS

New Models . . . Designed for testing D. C. Electrical Apparatus on Regular A. C. Lines. Equipped with Full-Wave Dry Disc Type Rectifier, Assuring Noise-less, Interference-Free Operation and Extreme Long Life and Reliability.

NEW MODELS **NEW DESIGNS**
NEW LITERATURE

"A" Battery Eliminator, DC-AC Inverters
Auto Radio Vibrators

ATR See your jobber or write factory

AMERICAN TELEVISION & RADIO CO.
Quality Products Since 1931
SAINT PAUL 1, MINNESOTA-U.S.A.

imperative that a high quality amplifier be used having an undistorted output of at least 50 watts. This requirement was met with the *McIntosh 50W2* amplifier.

Since an amplifier is an electronic device, passing a wide band of frequencies, it is necessary that the amplifier does not change the characteristics of the signals that are transmitted to it, otherwise the deletion of frequencies and/or high order of intermodulation distortion will result which can be most irritating to the listener. It is not sufficient to talk of gain frequency characteristics alone simply because every good amplifier, with an audio range from 20 to 20,000 cycles, has a variation of less than one db. It is obvious to the experienced engineer that this is a very difficult variation to measure. An amplifier will pass no more peak power per instant than it will power on a continuous basis, usually with the same amount of distortion. Therefore the amplifier must be designed for the maximum peak and for the maximum frequency range it is desirable to pass.

Sacia, back in 1925, showed that the average acoustical power in speech is quite low and that the momentary or instantaneous peaks of speech were found to be 200 times this average power. In music it is found that this ratio may go up from 200 to 400. Therefore we know that an amplifier, or other device, must be able to pass peaks averaging from two hundred to four hundred times the average power in speech or music.

As an example, suppose $\frac{1}{4}$ watt average electrical power is fed into a loudspeaker (which is about right for monitoring a program). It is evident that from 50 to 100 watts would be required to satisfy the peak powers of the original sound. It may seem somewhat astonishing to realize the sort of powers that are needed for adequate reproduction and recording of speech and music even for home systems. While these peaks are often of very short duration and do not necessarily fatigue the listener, they do chop off at the top. It results in loss of the dramatic nature and thrill of listening to reproduced sound.

With the amplifier efficiencies that are now available (60 to 65%) over the conventional 15 to 20%, it is possible to achieve some of the dynamic power peaks on a practical scale and at a practical cost. It is recommended, therefore, that the basic amplifier used for either recording or reproduction have a power of approximately 50 watts. This amplifier provides a reasonably safe margin and provides for the realistic reproduction of speech and music. Complete details on the design of the amplifier will appear in later chapters.

The 50W2 amplifier is provided with a 600 ohm line input transformer. In order to provide sufficient gain a separate plug-in booster amplifier, especially designed for the unit, was employed. The 600 ohm output of the

amplifier normally connects through the jack field to the playback speaker.

The Monitor Amplifier

Our fifth requirement was met by employing a *Radio Craftsmen RC2* amplifier. An input bridging transformer was added to match the impedance of the bridging bus. The 600 ohm output connects to the jack field and is "normalised" to the monitor speaker. The amplifier provides approximately 10 watts output at low distortion.

The Spare Amplifier

It is always good practice when designing a system to provide a spare record-reproduce-monitor amplifier, should it be needed. This unit is based on the design of *John Goodell* and employs the *Scott Dynamic Noise Suppressor*. It may be seen in the photo in the upper right hand corner of the dual rack assembly. Construction of this amplifier will be treated separately in a later chapter. The input and output circuits of this amplifier terminate in the jack field and the amplifier may be substituted (by means of patching) for any other amplifier in the circuit with perfect impedance match.

The FM-AM Tuner

This unit is the *Radio Craftsmen RC10* tuner with built-in audio pre-amplifier. We found it desirable, when laying out this system, to provide emergency preamplification for the several inputs. By employing this new tuner, we were provided with such spare facilities. Normally this tuner connects to the jack field and the detector output of the tuner feeds normally to the input of the AE2 preamp equalizer. When needed, any of the phono pickups or other input sources may be patched in to the RC10 tuner. Here equalization is also provided for the program source as well as provision for complete bass and treble tone control.

The Television Tuner

Inasmuch as the equipment was to be used not only as a recording-reproduce system, but as a television entertainment position, we decided to incorporate our television tuner within the assembly. The tuner used and shown in the photos is the *Radio Craftsmen RC100A*. It is fed by a regular outdoor television antenna and this also serves to provide signals for the FM-AM tuner. A 1000 ohm resistor connects between the antenna terminal of the tuner to one side of the television antenna. This provides the required isolation.

The output of the TV tuner also terminates in the jack panel and from them is normalised to a 2-stage audio amplifier and separate speaker. In this way it is not necessary to operate the entire audio group in order to provide audio amplification for the television tuner when used alone. If a recording is to be made from a TV program source, it is a simple matter to

1000 KC crystal BT cut.....\$3.95
 3" scope shield.....1.29
 2 speed dial drive for 1/4" shaft ratios 5:1 to 1 .39
 ATC 100 mmfd air trimmer screwdriver shaft......29
 -10 +5 Weston modulation meter Weston 301. 8.95
 J37 key......69
 500 watt 12.5 ohm power rheostat..... 3.49



50 mmfd 5 KV GE vacuum condenser.....\$1.49
 2r. 6v, 12v vibrators any type......98
 Rotary switch GE Mylex. 2 deck SPST......39
 1 mfd 5000v oil condenser Micamold.....2.98
 2 mfd 3000v oil condenser Aerovox.....3.25
 3 mfd 4000v oil condenser Micamold.....3.95
 24 mfd 1500v DC 3KV flash. Excellent for speed lamp..... 3.95

TUBES!! BRAND NEW! STANDARD BRANDS! NO SECONDS! COMPARE! TUBES!!

0A3/VR75 \$1.29	8C31/C1D \$3.49	217C\$6.75	811\$2.49	8014\$24.50	0A2	5Z4	6SN7GT	12S77
0B3/VR90 1.29	8C1512.75	227A/5C27 2.49	8122.85	802089	0A4G	6A3	6S07	25K7
0C3/VR105 1.95	8C212.39	249C2.95	812H6.90	80255.95	0B2	6A4LA	6SR7GT	12SL7
0D3/VR150 .89	8C21-5L13.10	250R5.95	8138.95	90010.24	0B4	6A6	6S87	12SN7
1B222.95	8DP13.10	350TH18.95	8142.25	900265	01A	6A7	6S97	12SQ7
1B238.75	8DP1-5A3.95	350TL18.95	8152.25	900365	1A3	6A8	6SUGT	12SR7
1B244.95	8DP1-52A4.75	274A5.95	8161.19	900465	1A4P	6A9	6SUTGT	12ST7
1B262.95	8D21A1.98	274B1.95	82698	90052.35	1A5GT	6AB7	6SUTGT	12T23
1B2724.50	3E2912.95	276A6.95	82812.75	90062.29	1A6	6AB7	6SUTGT	14A4
1B291.95	3E29A1.95	290R5.95	8301.95	90072.25	1A7GT	6AC7	6T7	14A7
1B321.79	3GP14.75	294A3.95	830B12.95	900865	1A8	6AD7C	6T7C	14B6
1B3624.95	3HP12.89	300B3.95	830C3.95	900965	1A9	6AE7C	6T7C	14C7
1B3832.50	3L24A14.29	274A5.95	8321.95	901065	1B3/25S	6AF6G	6U7G	14D7
1N21Xtal 1.89	4-125A26.95	304TL2.95	832A7.95	CK10D	6AG7	6AG7	6V6	14E7
1N21A Xtal 1.79	4-250A29.95	305A24.95	833A37.50	CK20AX	6AH6	6AG7	6V6	14F7
1N22 Xtal 1.35	4B21/EL5B 9.95	303A/RR75 9.95	836A1.25	CK30AX	6AJ5	6AG7	6V6	14G7
1N23 Xtal 1.25	4B24/EL3C 5.95	316A6.95	8378.95	CK40AX	6AK6	6AG7	6V6	14H7
1N23A Xtal 1.75	4B25/6C1 7.50	323A/VA24.50	84133	CK50AX	6AL5	6AG7	6V6	14J7
1N23B Xtal 3.95	4B26/6C2 7.50	327A/CC37 4.95	84233	CK60AX	6AL5	6AG7	6V6	14K7
1N271.69	4B282.95	328A12.95	8453.75	CK70AX	6AL5	6AG7	6V6	14L7
1N3495	4B323.95	331A12.95	84929.50	CK80AX	6AL5	6AG7	6V6	14M7
1N34A4.95	4C27/CV9249.50	330A49.50	85113.95	CK1005	6AR3	6AG7	6V6	14N7
1P233.49	4C3527.50	350B1.75	8526.25	CK106	6AUG	6AG7	6V6	14O7
1P2479	4D3212.95	368AS2.39	8606.95	CK106	6AUG	6AG7	6V6	14P7
1P462.95	4D3212.95	371B65	86429	CK106	6AUG	6AG7	6V6	14Q7
1S213.79	4E27/25D717.95	388A1.75	8651.45	CK106	6AUG	6AG7	6V6	14R7
2AP14.95	5AP13.69	394A5.95	866A1.15	CK106	6AUG	6AG7	6V6	14S7
2AP23.95	5AP1A3.69	417A8.95	869A26.50	CK106	6AUG	6AG7	6V6	14T7
2C21/RK431.19	5BP14.29	466A2.95	872A1.25	CK106	6AUG	6AG7	6V6	14U7
2C22/71931.39	5BP1A4.29	466B4.66	873A1.25	CK106	6AUG	6AG7	6V6	14V7
2C23/RK341.19	5BP1B4.29	466C4.66	874A1.25	CK106	6AUG	6AG7	6V6	14W7
2C2924.50	5CP12.49	466D4.66	875A1.25	CK106	6AUG	6AG7	6V6	14X7
2C402.95	5CP1A2.49	466E4.66	8761.25	CK106	6AUG	6AG7	6V6	14Y7
2C4314.95	5CP1B2.49	466F4.66	8771.25	CK106	6AUG	6AG7	6V6	14Z7
2C441.49	5CP1C2.49	466G4.66	8781.25	CK106	6AUG	6AG7	6V6	15A7
2C467.95	5CP1D2.49	466H4.66	8791.25	CK106	6AUG	6AG7	6V6	15B7
2C512.95	5CP1E2.49	466I4.66	8801.25	CK106	6AUG	6AG7	6V6	15C7
2D211.25	5JP12.45	466J4.66	8811.25	CK106	6AUG	6AG7	6V6	15D7
2E224.19	5JP1A2.45	466K4.66	8821.25	CK106	6AUG	6AG7	6V6	15E7
2E241.95	5JP1B2.45	466L4.66	8831.25	CK106	6AUG	6AG7	6V6	15F7
2E263.69	5JP1C2.45	466M4.66	8841.25	CK106	6AUG	6AG7	6V6	15G7
2E302.29	5JP1D2.45	466N4.66	8851.25	CK106	6AUG	6AG7	6V6	15H7
2E31A1.95	5JP1E2.45	466O4.66	8861.25	CK106	6AUG	6AG7	6V6	15I7
2E328.45	5JP1F2.45	466P4.66	8871.25	CK106	6AUG	6AG7	6V6	15J7
2E366.50	5JP1G2.45	466Q4.66	8881.25	CK106	6AUG	6AG7	6V6	15K7
2E373.95	5JP1H2.45	466R4.66	8891.25	CK106	6AUG	6AG7	6V6	15L7
2E3839.50	5JP1I2.45	466S4.66	8901.25	CK106	6AUG	6AG7	6V6	15M7
2E398.49	5JP1J2.45	466T4.66	8911.25	CK106	6AUG	6AG7	6V6	15N7
2E424.69	5JP1K2.45	466U4.66	8921.25	CK106	6AUG	6AG7	6V6	15O7
2E443.95	5JP1L2.45	466V4.66	8931.25	CK106	6AUG	6AG7	6V6	15P7
2E4639.50	5JP1M2.45	466W4.66	8941.25	CK106	6AUG	6AG7	6V6	15Q7
2E4839.50	5JP1N2.45	466X4.66	8951.25	CK106	6AUG	6AG7	6V6	15R7
2E5039.50	5JP1O2.45	466Y4.66	8961.25	CK106	6AUG	6AG7	6V6	15S7
2E5239.50	5JP1P2.45	466Z4.66	8971.25	CK106	6AUG	6AG7	6V6	15T7
2E5439.50	5JP1Q2.45	466AA4.66	8981.25	CK106	6AUG	6AG7	6V6	15U7
2E5639.50	5JP1R2.45	466AB4.66	8991.25	CK106	6AUG	6AG7	6V6	15V7
2E5839.50	5JP1S2.45	466AC4.66	9001.25	CK106	6AUG	6AG7	6V6	15W7
2E6039.50	5JP1T2.45	466AD4.66	9011.25	CK106	6AUG	6AG7	6V6	15X7
2E6239.50	5JP1U2.45	466AE4.66	9021.25	CK106	6AUG	6AG7	6V6	15Y7
2E6439.50	5JP1V2.45	466AF4.66	9031.25	CK106	6AUG	6AG7	6V6	15Z7
2E6639.50	5JP1W2.45	466AG4.66	9041.25	CK106	6AUG	6AG7	6V6	16A7
2E6839.50	5JP1X2.45	466AH4.66	9051.25	CK106	6AUG	6AG7	6V6	16B7
2E7039.50	5JP1Y2.45	466AJ4.66	9061.25	CK106	6AUG	6AG7	6V6	16C7
2E7239.50	5JP1Z2.45	466AK4.66	9071.25	CK106	6AUG	6AG7	6V6	16D7
2E7439.50	5JP1AA2.45	466AL4.66	9081.25	CK106	6AUG	6AG7	6V6	16E7
2E7639.50	5JP1AB2.45	466AM4.66	9091.25	CK106	6AUG	6AG7	6V6	16F7
2E7839.50	5JP1AC2.45	466AN4.66	9101.25	CK106	6AUG	6AG7	6V6	16G7
2E8039.50	5JP1AD2.45	466AO4.66	9111.25	CK106	6AUG	6AG7	6V6	16H7
2E8239.50	5JP1AE2.45	466AP4.66	9121.25	CK106	6AUG	6AG7	6V6	16I7
2E8439.50	5JP1AF2.45	466AQ4.66	9131.25	CK106	6AUG	6AG7	6V6	16J7
2E8639.50	5JP1AG2.45	466AR4.66	9141.25	CK106	6AUG	6AG7	6V6	16K7
2E8839.50	5JP1AH2.45	466AS4.66	9151.25	CK106	6AUG	6AG7	6V6	16L7
2E9039.50	5JP1AI2.45	466AT4.66	9161.25	CK106	6AUG	6AG7	6V6	16M7
2E9239.50	5JP1AJ2.45	466AU4.66	9171.25	CK106	6AUG	6AG7	6V6	16N7
2E9439.50	5JP1AK2.45	466AV4.66	9181.25	CK106	6AUG	6AG7	6V6	16O7
2E9639.50	5JP1AL2.45	466AW4.66	9191.25	CK106	6AUG	6AG7	6V6	16P7
2E9839.50	5JP1AM2.45	466AX4.66	9201.25	CK106	6AUG	6AG7	6V6	16Q7
2E10039.50	5JP1AN2.45	466AY4.66	9211.25	CK106	6AUG	6AG7	6V6	16R7
2E10239.50	5JP1AO2.45	466AZ4.66	9221.25	CK106	6AUG	6AG7	6V6	16S7
2E10439.50	5JP1AP2.45	466BA4.66	9231.25	CK106	6AUG	6AG7	6V6	16T7
2E10639.50	5JP1AQ2.45	466BB4.66	9241.25	CK106	6AUG	6AG7	6V6	16U7
2E10839.50	5JP1AR2.45	466BC4.66	9251.25	CK106	6AUG	6AG7	6V6	16V7
2E11039.50	5JP1AS2.45	466BD4.66	9261.25	CK106	6AUG	6AG7	6V6	16W7
2E11239.50	5JP1AT2.45	466BE4.66	9271.25	CK106	6AUG	6AG7	6V6	16X7
2E11439.50	5JP1AU2.45	466BF4.66	9281.25	CK106	6AUG	6AG7	6V6	16Y7
2E11639.50	5JP1AV2.45	466BG4.66	9291.25	CK106	6AUG	6AG7	6V6	16Z7
2E11839.50	5JP1AW2.45	466BH4.66	9301.25	CK106	6AUG	6AG7	6V6	17A7
2E12039.50	5JP1AX2.45	466BJ4.66	9311.25	CK106	6AUG	6AG7	6V6	17B7
2E12239.50	5JP1AY2.45	466BK4.66	9321.25	CK106	6AUG	6AG7	6V6	17C7
2E12439.50	5JP1AZ2.45	466BL4.66	9331.25	CK106	6AUG	6AG7	6V6	17D7
2E12639.50	5JP1BA2.45	466BM4.66	9341.25	CK106	6AUG	6AG7	6V6	17E7
2E12839.50	5JP1BB2.45	466BN4.66	9351.25	CK106	6AUG	6AG7	6V6	17F7
2E13039.50	5JP1BC2.45	466BO4.66	9361.25	CK106	6AUG	6AG7	6V6	17G7
2E13239.50	5JP1BD2.45	466BP4.66	9371.25	CK106	6AUG	6AG7	6V6	17H7
2E13439.50	5JP1BE2.45	466BQ4.66	9381.25	CK106	6AUG	6AG7	6V6	17I7
2E13639.50	5JP1BF2.45	466BR4.66	9391.25	CK106	6AUG	6AG7	6V6	17J7
2E13839.50	5JP1BG2.45	466BS4.66	9401.25	CK106	6AUG	6AG7	6V6	17K7
2E14039.50	5JP1BH2.45	466BT4.66	9411.25	CK106	6AUG	6AG7	6V6	17L7
2E14239.50	5JP1BI2.45	466BU4.66	9421.25	CK106	6AUG	6AG7	6V6	17M7
2E14439.50	5JP1BJ2.45	466BV4.66	9431.25	CK106	6AUG	6AG7	6V6	17N7
2E14639.50	5JP1BK2.45	466BW4.66	9441.25	CK106	6AUG	6AG7	6V6	17O7
2E14839.50	5JP1BL2.45	466BX4.66	9451.25	CK106	6AUG	6AG7	6V6	17P7
2E15039.50	5JP1BM2.45	466BY4.66						

SAVE \$ ON \$UN SURPLUS AND STANDARD SPECIALS!

CRYSTALS Low Freq.

FT-241 A holder 1/2" pin spacing, for ham and general use. Xtal controlled Signal Generators, marked in army Mc harmonic frequencies—Directions for deriving fundamental frequencies enclosed. Listed below by fundamental frequency, fractions omitted.

412	426	442	475	493	504	516	372	381	390	401
413	427	443	477	494	506	518	374	383	391	402
414	429	444	479	495	507	519	375	384	392	403
415	431	445	481	496	508	522	376	386	393	404
416	433	446	483	497	509		377	387	394	405
418	434	447	484	498	511		378	388	395	408
419	435	448	485	503	515		380		396	409
420	436	452	487						397	411
422	437	458	488						400	
423	438	472	490						each	
424	440	473	491						each	
425	441	474	492						each	

450	531	944	Frequency	SPECIAL 200 kc
452.777	533.333		Standard	Xtals without holders
461.111	536.111		98.356 kc	21-32" x 23-32"
464.815	537.500		3-pr. holder	69c each
465.277	538.888			3 for \$2.00
526.388				
529.166				
530.555				

HAM CRYSTALS

FT-243 holders 1/2" pin spacing, for ham and experimental use. Fractions omitted.

4190	6140	7740	8273	3735	5873	6440	7306	7640
5030	6173	7773	8306	5305	5875	6450	7340	7673
5485	6206	7806		5677	5900	6473	7370	7706
6006	6208	7840		5706	5906	6475	7406	7806
6040	6773	7873		5740	5925	6506	7440	8173
6073	6840	7906		5750	5940	6540	7473	8340
6075	6873	7925		5760	5973	6573	7506	
6100	6906	7973		5773	5975	6606	7540	
6106	6973	8240		5775	6273	6640	7573	
				5806	6340	6673	each	
				5825	6373	6706	99c	
				5840	6406	6740		
				5850	6425	6806	10 for \$9.00	

SCR-522 XTALS

5910	6610	7580
6370	7350	7810
6450	7480	7930
6470		
6407.9	each	
6522.9	1.29	
6547.9		

BC-610 XTALS

2045	2260	2415	3215	3570
2105	2282	2435	3237	3580
2125	2300	2442	3250	3945
2145	2305	2452	3322	3955
2155	2320	2545	3510	3995
2220	2360	2557	3520	each
2258	2390	3202	3550	1.29

Payments must accompany order. Enclose 20c for postage and handling. Minimum order \$2.00 plus postage. Crystals shipped packed in cloth bags inasmuch as they are shock mounted. All shipments guaranteed.

Reduced for Clearance BENDIX 100 WATT TRANSMITTER



One switch used to change 10-20-40-80 meter bands.

FOUR SEPARATE ELECTRONIC COUPLED OSCILLATORS: these can be easily converted to 20-40-80 meters. Crystal required for 10 meters. Each electronic coupled oscillator dial has 3000 divisions enabling quick precision shifting. This transmitter was constructed of the highest quality of precision parts with laboratory precision. Four separate output tanks; one 4-position selector channel switch having seven sections which changes the ECO, IPA and output tanks simultaneously. All the controls are mounted on the front panel. The housing is cast aluminum; shields and case are sheet aluminum. Dimensions: 11 x 12 x 15 inches, weighing 35 1/2 lbs. Complete, simple instructions for conversion furnished. Uses three 807, four 12SK7 tubes, one 2-inch 5-amp. R.F. meter. A complete coverage transmitter, for the new or experienced amateur.

A TRUE HAM VALUE complete with tubes was \$49.95

NOW-ONLY \$29.95 LIKE-NEW \$19.95 USED

G.I. PORTABLE WINDUP PHONOGRAPH

Heavy duty spring motor. Plays 3 records on 1 winding. Packed with 100 needles. Brand New \$9.95

TERMS: All items F. O. B., Washington, D. C. Above \$30.00, 25 per cent with order, balance C.O.D. Foreign orders cash with orders, plus exchange rate.

SUN RADIO

OF WASHINGTON, D. C.
938 F STREET, N. W. WASH. 4. D. C.

patch in the output of the tuner into one of the preamplifiers.

The Speaker Lines

Two separate speaker lines are used, one going to a special monitor speaker, the other to the playback speaker. Both are of 600 ohms. Two 8" Permoflux speakers (connected in parallel) are used for monitoring, while the playback speaker is the new Jensen G610, described elsewhere in this issue.

The Recording Turntables

The turntables are Presto 6N units which have been in use for many years at the author's installation. Normally one of the tables is used for disc recording. The recording mechanism has been removed from one table in order to provide space for the mounting of additional phono reproducers for experimental purposes. Shown are two Pickering 130M pickups and a G-E variable reluctance unit. Another pickup used in this system is the Audax Polyphase transcription reproducer.

Magnetic Tape Recorder

The recorder shown in the photos is the Magnecord PT6JA. Since taking the photos these have been replaced with the new PT63JA. The 600 ohm output of the Magnecord amplifier terminates in the jack panel, as does the signal from the monitoring head. This will be discussed in greater detail in later chapters.

Meter Panel

It is necessary to provide accurate means for measurement of line and power levels. Shown are two Simpson Model 49 standard vu. meters. One, with necessary attenuator to extend the range of the instrument is used for power level measurements. The other meter is normally connected to the bridging bus, and audio level is maintained through the line at plus 4 dbm.

It is not possible in this limited amount of space to discuss in detail the many components comprising this system. In later chapters we will deal with each unit separately and discuss its application.

(To be continued)



TESCO

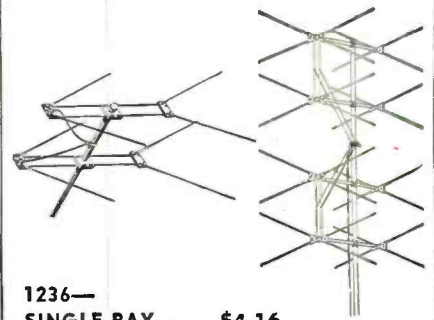

1236— SINGLE BAY..... \$4.16

1237— DOUBLE BAY.... \$8.32 - \$17.80

1230	Double Bay Conical	\$8.19
1215	Swift Rig Folded Hi Folded Low	4.87
1814	Economy Chimney Mount	Dozen lots 1.20
1302 to 1306	Five El. Yagi any Lo Channel	12.38
1307 to 1313	Five El. Yagi any Hi Channel	5.45
1219	Swift Rig Folded Hi Straight Lo	4.48
2102	DeLuxe Indoor Antenna	2.49
1860	Chimney Mount	Dozen lots 1.40
1905	3 1/2" Mast Snap On Standoff	Per 100 4.00
1873	3 1/2" Mast Standoff Insulator Wrap	
	Around	Per 100 6.00
1874	4" Nail In Insulator—lots of 250	.025
1870	3 1/2" Wood Screweye Insulator—lots of 250	.025
1229	Single Bay Conical	3.84
1231	Four Bay Conical	17.80

Send for quantity prices and complete list

TELEVISION SUPPLY CO.
Box 213 Gracie Square Station
New York, N. Y.

Seein's Believin'

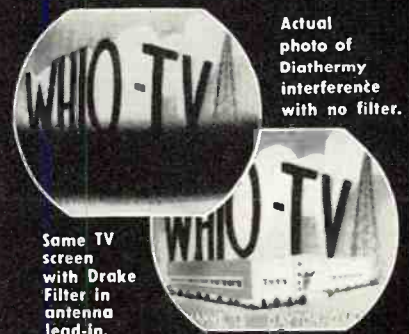

THE R. L. DRAKE High Pass Television Filter

protects the R.F. and I.F. bandpass of the TV set from strong radio frequency interference generated by:

- Amateur Radio Transmitters
- Shortwave Broadcast Stations
- X-ray and Diathermy
- Industrial R. F. Heating
- Auto Ignition and Motors
- Neon Lights, Appliances, etc.

Two models available—TV-300-50HP for 300-Ohm Twin Lead and TV-72-50HP for Small 72-Ohm Coax.

\$5.95 LIST

Discounts to dealers, servicemen and amateurs

Drake Filters are sold by all leading distributors. Try one today.

Many dealers include one with each installation.

THE R. L. DRAKE CO.
11 Longworth St., Dayton 2, Ohio

Pre - Publication Announcement!

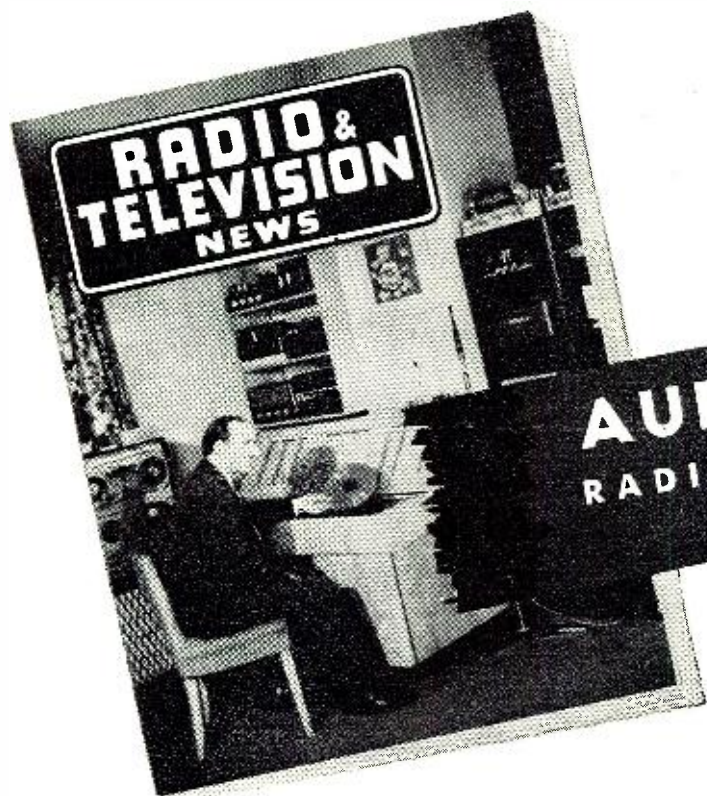

AUDIO EDITION
RADIO & TELEVISION
NEWS

For **AUDIO ENGINEERS**
COMMUNICATIONS
BROADCAST PERSONNEL
RESEARCHERS

Combining..... *All Radio & Television News Content* *Plus A Special **AUDIO** Section*

BECOME A CHARTER SUBSCRIBER.
SUBSCRIBE TO THE SPECIAL AUDIO EDITION
OF RADIO & TELEVISION NEWS TODAY!

USE THE ORDER CARD FACING THIS PAGE—
If you **ACT NOW** we'll be able to start off your
subscription with the very first issue of the new
AUDIO Edition. That way you won't miss a
single important AUDIO development!
SEND NO MONEY. We shall bill you with de-
livery of first issue!

Yes! *all under one cover*, you may now enjoy
double benefit . . . **RADIO & TELEVISION NEWS'**
broad electronics coverage — plus a vital new
Special Section devoted exclusively to **AUDIO!**
Don't let **AUDIO** pass you by! Incorporate impor-
tant **AUDIO** information with your **RADIO &**
TELEVISION NEWS reading **EVERY MONTH!**

ZIFF-DAVIS Publishing Company • 185 N. Wabash Avenue, Chicago 1, Illinois
Publishers also of: RADIO-ELECTRONIC ENGINEERING — POPULAR PHOTOGRAPHY — FLYING — PHOTOGRAPHY
ANNUAL 1951 Edition — MASTERPIECES — MODERN BRIDE — FICTION GROUP — ZIFF-DAVIS COMICS

November, 1950

139

For a Better Understanding of FM Systems in All Phases of Radio and Television...

FM TRANSMISSION AND RECEPTION

By John F. Rider and Seymour D. Uslan

With the rapid growth of Television and FM radio, with expansion in the various types of communications systems, the material contained in FM TRANSMISSION AND RECEPTION is increasingly valuable to the experienced technician and beginner as well. The more you know about FM, the more thorough your job can be—the greater your earning power becomes. The entire subject of frequency modulation is covered fully... all types of systems employed in television, radio, amateur radio, railroad, aviation, marine, police, point-to-point and mobile receivers. Basic theory, transmission, reception, circuit design and servicing are covered, with mathematics kept to a minimum. Almost all of the presently used FM commercial transmitters are described in detail. A question section follows each of the "Meaty" chapters.

416 Pages, Profusely Illustrated,....\$3.60

Shows You How to Get the MOST Out of Your Oscilloscope...

ENCYCLOPEDIA ON CATHODE-RAY OSCILLOSCOPES AND THEIR USES

by Rider and Uslan

This is a book of a thousand-and-one uses. It teaches you how to use an oscilloscope properly. It tells what is inside the 'scope and how to get the most out of it. The book shows what can and cannot be done with an oscilloscope. When planning to buy equipment, this text helps you avoid costly mistakes in selecting the type of instrument best suited to your needs. The book begins with basic theory of cathode-ray tube operation, and then proceeds through application in 'scopes and TV receivers. There are full and clear explanations for uses in every field and research activity which employs a cathode-ray oscilloscope. All 'scopes produced during the past ten years, more than 70 different models are described—with schematic wiring diagrams. Almost 500,000 words and about 3,000 illustrations are incorporated in the more than 992 pages. Invaluable for engineers, servicemen, teachers, students, Armed Forces, radio amateurs, research laboratories, etc. There is no other book like it!

992 Pages, 22 Chapters, 8½" x 11"...\$9.00

10-DAY FREE TRIAL

Order these books today. Keep them for 10 days if you are not completely satisfied, return them to us and your money will be refunded.

RUSH THIS COUPON TODAY

JOHN F. RIDER PUBLISHER, Inc.
480 Canal Street, New York 13, N. Y.
Please send me the following books on your 10-Day Money-Back Offer.
TV and Other Receiving Antennas (Theory and Practice)..... \$.....
Encyclopedia on Cathode-Ray Oscilloscopes and Their Uses..... \$.....

NAME

ADDRESS

CITY ZONE... STATE.....

Check for \$..... Money-Order for \$.....
Enclosed. 2

RCA Sound System (Continued from page 63)

RCA LC1A loudspeaker mechanism for the frequencies 500, 1000, 3000, 7000, 10,000 and 15,000 cycles are shown in Fig. 11A. The directivity patterns show that the angular spread for a variation of ± 3 db. is more than 90° up to 15,000 cycles.

The total r.m.s. distortion frequency characteristic for the LC1A loudspeaker for 1, 2, and 10 watts input is shown in Fig. 4B.

The response frequency characteristic of the 515S1 speaker mechanism mounted in the cabinet of Fig. 14 with port opened and closed are shown in Fig. 15A. The response is uniform from 50 to 12,000 cycles.

The directional characteristics of the RCA 515S1 loudspeaker mechanism for the frequencies 500, 1000, 2500, 5000, 7000, and 10,000 cycles are shown in Fig. 11B. The directivity patterns show that the angular spread for a variation of ± 3 db. is more than 60° up to 10,000 cycles.

The total r.m.s. distortion frequency characteristic for the 515S1 speaker

¹⁷Carson, Burt and Reiskind; "RCA Review," Vol. 10, No. 2, page 173, 1949.

¹⁸The wide range pickup cartridge RCA Stock No. 74625 was developed by A. D. Burt, RCA Victor Division of RCA.

¹⁹In order to realize the full high frequency response of the wide range cartridge, it is necessary to remove the volume control from the 9JY changer and to use the shortest possible length of low capacity cable between the cartridge and the amplifier.

²⁰Carson, Burt and Reiskind; "RCA Review," Figs. 12 and 11 respectively.

for 1, 2, and 5 watts input is shown in Fig. 4A.

Record Changer

A new changer and record of complementary design having a rotational speed of 45 r.p.m. has been developed¹⁷ and commercialized. This system provides a disc record and reproducer with wide frequency range, low noise, and low distortion characteristics. The records are 6½ inches in diameter. Each record contains up to 5½ minutes of playing time. The record changer will handle up to ten records.

The 9JY model of the new record changer is provided with a medium frequency range pickup designed for use with conventional radio receivers and phonographs. A wide range pickup cartridge has also been developed¹⁸ and may be substituted for the conventional pickup for wide frequency range reproduction.¹⁹ The response frequency characteristic of the wide range pickup using a standard test record²⁰ is shown in Fig. 16B. When playing the 45 r.p.m. records, it is necessary to consider the recording characteristics²⁰ used in making the records. Taking the recording characteristic into account the response frequency characteristic of the 45 r.p.m. record and the wide range pickup is shown in Fig. 16A.

Over-All System

A photograph of the complete system, including the 9JY record changer, amplifier, RCA LC1A loudspeaker, and cabinet is shown in Fig. 1. In order to achieve accurate reproduction of the

Fig. 15. (A) Response frequency characteristics of the RCA 515S1 loudspeaker mechanism mounted in the cabinet (Fig. 14) with port opened and closed. (B) LC1A response.

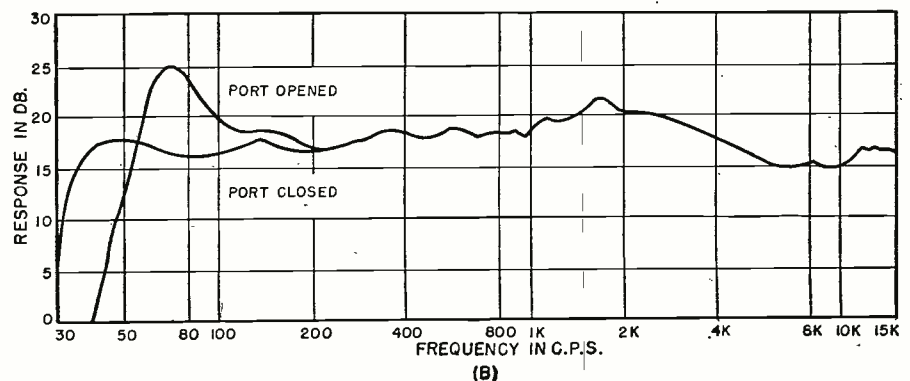
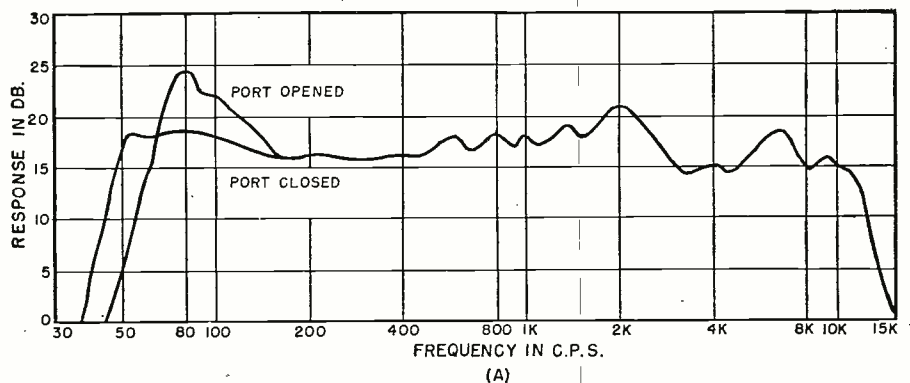

ARROW has the VALUES!

CONDENSERS

	Each	
1 mfd. 6000 VDC. OIL FILLED	\$1.98	
.00025 mfd. 25000 VDC. OIL FILLED	2.95	
.4 mfd. 1500 VDC. OIL FILLED	.29	10 for 2.49
2 mfd. 600 VDC. OIL FILLED	.39	
	3 for 1.00	
1 mfd. 600 VDC. OIL FILLED	.24	5 for 1.00
4 mfd.—500 VDC oil filled	.49	each .59
1-1-1—1200 VDC. OIL FILLED	.59	
	2 for 1.00	
50 mmfd.—5KV—5 Amp. Vacuum Cond.	1.19	

IS-185 Weston Voltmeter Model 433—0 to 150 VAC 25 to 2400 cycles. **\$24.95**
New

FLAP PITCH MOTOR

24 VDC. will operate on AC—3300 or 11,000 R.P.M. Complete with gear box and limit switches. **\$2.95**

RT7/APN1 TRANSCEIVER UNIT—

Used as an altimeter, it may be converted for signaling control circuits, etc. Complete with 14 tubes and dynamotor they are in good used condition at **\$6.95** the amazingly low price of.



Portable VHF Communication Unit

Two-way radio telephone equipment designed for operation between 152 and 162 megacycles FM. Adaptable for many uses, a complete unit including the rechargeable storage battery weighs but fifteen pounds, and is housed in a sturdy case 11½" x 9" x 4¼", provided with shoulder straps.

This brand new set of big name manufacture comes complete with battery, battery tray, **\$89.50** and handset but less crystal. **\$19.95**
Battery charger is extra at.

Mobile VHF Communication Unit

Adaptable for many mobile uses, this is a compact unit 3½" x 8" x 15½", operating on 152 to 162 megacycles FM. It is six-volt powered direct from storage battery, and is complete with the tone filter and crystal; handset, control box, antenna and installation kit. **\$129.50**

Brand new, ready to go. **\$2.95**
Extra 18" stub type antennae are available.

HEADSETS—MIKES

HS-23 Hi Imp. Headsets	New	\$2.95
HS-33 Lo Imp. Headsets	New	2.95
HS-30 Hi Imp. Headsets	New	1.50
	Used	.79
HS-38 Lo Imp. Headsets	Used	.75
T-17D Carbon Mike	New	2.75
	Used	1.50
T-24 Hi Imp. Carbon Mike	New	1.19
T-30 Throat Mike	New	.98
T-45 (or Navy) Lip Mike	New	.98

RC 150 EQUIPMENT

Receiver BC 1161 A	New	\$29.95
Transmitter BC 1160 A	New	29.95
Control unit BC 1162 A		
New but less tubes		14.95
Signal Generator I 198 A	New	24.95

COMMAND (SCR 274 N) EQUIPMENT

	Used	New
BC-453	\$12.95	
BC-454	5.95	
BC-455	7.95	\$9.95
BC-456		2.95
BC-457	5.95	
BC-458	5.95	8.95
BC-696	14.95	24.95
BC-450—3 Receiver Remote Control	.89	1.95
BC-442		2.95
3 Receiver Rack	1.95	
2 Transmitter Rack	1.50	
Complete Command set as removed from aircraft—3 receivers—2 transmitters—Relay unit—control boxes—mounting racks—plugs—modulator and dynamotors—crated Set.		\$34.50

MISCELLANEOUS SPECIALS!

	Used	New
R 7/APS 2 Receiver-Indicator		\$79.50
R 78/APS-15 Receiver-Indicator	\$34.50	
ASB 7 Indicator Scope	12.95	
SCR 522 Transceiver 100 to 150 MC.	34.95	75.00
MN 26 C	17.50	24.95
RA 10 DA Receiver	17.50	24.95
RT7/APN1 Transceiver	6.95	9.95
APN 1 Complete		24.50
BD 71 6 Pos. Switchboard	9.95	12.95
EE 8 Field Phones	7.95	
BC 347 Interphone Amplifier		2.95
I-70 Tuning Meter		.89
BC 461 Veeder Root Counter		.59
BC 442 Less Condenser	1.49	1.95
APS 13 UHF Antenna, Pair		.98
FL 8 Filter		2.95
I-97 Bias Meter	3.95	4.95
RM 29 Remote Telephone Control	7.95	9.95
RL 42 Antenna Gearbox Motor and Reel	4.95	7.50
TS 10—Sound powered phones	6.50	
BC 1066 A—150 to 225 MC Portable Receiver adaptable to many amateur uses. In Canvas Carrying Bag, New		\$6.95
Tuning Units for BC 375—Presently most numbers are available in excellent condition with case at.		\$2.95 ea.
BC 306—Antenna Tuning Unit for BC 375. Excellent condition		\$1.50 ea.
One Tube Interphone Amplifier—Small compact aluminum case fully enclosed. 2¼" x 3¾" x 5¾". Less Tube		79c

RC 100 B RADIO EQUIPMENT

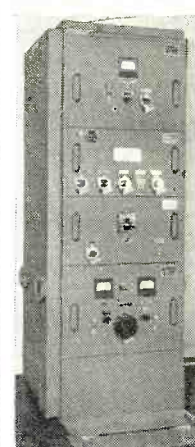

Consisting of the following:

- CH-118 Standard 19" rack 5 feet tall.
- BC-769 Transmitter—470 megacycles
- BC-770 Keying unit for transmitter
- BC-768 Receiver—493.5 megacycles
- RA-52 Rectifier unit for Transmitter (Metered with 0-15 KV and 0-20 MA meters and controlled with transistor)
- AN-82B Antenna system
- FL-25 Wave Trap

MC-377 7/8 inch, 70 ohm air dielectric concentric line for transmission

- BC-773 Control Box
- BC-783 B Amplifier
- M-349 Air Compressor
- M-348 Oven (dehydrator)
- BC-771 Frequency meter
- TM 11-1113B Technical manual

This equipment may be purchased as a unit or any component separately. Prices will be furnished on request.

SURPRISE PACKAGE

20 lbs. Ass't radio parts. A \$25.00 value for only **\$1.95**

MONTHLY SPECIAL

AS-138/ARN—10 inch streamline loop as used with direction finding receivers. Fixed position, it is ideal for planes, boats, auto-mobiles. **\$1.95**

1D6/APN4 Scope unit complete with 5CP1 cathode ray tube and shield and all parts except smaller tubes and crystal. Used **\$9.95 ea.**

ARROW SALES, Inc.

Dept. N

1712-14 S. Michigan Ave., Chicago 16, Ill.
PHONE: HARRISON 7-9374

- 96Q1 Complete Autotune assembly with motor and frame as used in ARC-1 Transmitter. New **\$35.00**
 - BC 709 Battery operated lightweight interphone amplifier. Complete with tube and shock mount, but less battery. New **\$3.95**
 - SCR 183 Complete New **\$49.50**
 - 220 MA Circuit Breaker New **.59**
 - Collins VFO Dial—S calibrated ham bands from 3.2 Mc to 32 Mc; complete with pointer, gears, logging dial and flywheel. Scale 6" on 8" plate. New. each **.95**
 - C-18—Antenna coil assembly slug tuned used in BC 603 receiver. Frequency range 20-27.9 Mc.—fully shielded. New. 10 for **\$1.95**
 - I 82 F—Five Inch 360 degree compass indicator and Selsyn receiver. New **\$4.95**
 - A-81-2 Transmitter selsyn for I82 indicator. \$2.45 (Both I82F & Trans. Selsyn for **\$7.00**)
 - MC 385A—Headset Adapter New **49c**
- Information and Prices on Request**
- BC 639 Receiver with RA 42 Rectifier
 - RTA 1B Transceiver
 - TA 2324 Transmitter and MP 10G Power Pack
 - SCR 269 Compass Installation
 - R 5/ARN 7 Compass Installation
 - MN 26 Compass Installation
 - I. L. S. Installation (R 89-BC733)
 - MD-22-URA/TI Radar Modulator
 - AN APRI Receiver and Tuning Units
 - ASB7 Complete Radar Installation

BC-605 Interphone Amplifier

Easily converted to an ideal intercommunication set for office—home—or factory.

Original—New... **\$4.95**
Like New... **3.95**
(With Schematic)

See April 1950 Radio News for complete conversion data.



BC-604 Transmitter FM 20-28 MC

11 and 15 meters. Can be operated on 10 meters—10 channel push button crystal. With all tubes and meter but less dynamotor. **\$19.95**

Excellent Condition **19.95**
Crystals—
Set of 80 **19.95**

BC 603

Receiver—Good. Used **\$24.95**

BC 620

Receiver-Transmitter—2 crystal channels—20 to 27.8 MC FM—13 tubes. Metered, Plate and Filament. Used **\$9.95**

PE 97 or PE 117 or PE 120 Power Supply for above 6-12 volt vibrator type. Used less tubes, vib. & con. **\$2.95**

Used, complete **\$6.95**

FT 250 Mount for both BC 620 and PE 97 New **\$1.50**

BC 223

Brand new Transmitter with all three tuning units, two tuning unit cases, spare tube carrying case, shock mount and brace; but less tubes **\$29.95**

at new low price of

Set of 5 tubes **\$3.95**

Tuning units are available separately at. Ea. **\$2.50**

PE 125—12-volt Vibrator Pack New **\$12.95**

Used **8.95**

BC 906—Frequency Meter

Range 150-225 MC with modification possible for lower frequencies of TV, etc. Contains 0-500 DC microammeter and uses Battery pack of 1.5 V and 45 VDC. **\$10.95**

Like New—Less Batteries

HERMETICALLY SEALED CHOKES

10 H.	100 M.A.	59c
59 H.	100 M.A.	95c
3.7 H.	145 M.A.	59c
10 H.	20 M.A.	39c

All shipments FOB warehouse. 20% Deposit required on all orders. Minimum order accepted—\$5.00. Illinois residents, please add regular sales tax to your remittance.

INVENTORY SALE ALL PRICES CUT TO BONE

Westinghouse Cuprox Rectifier 0.64 Amp. 28 Volts. Reg. \$11.00 ea. Special \$3.95
25c TUBE SALE—#53-2A7-55-27-85-81... 6 for \$1.00
 56-57.....
TUBES—0Z4, 79c; 117P7.....95c
12 BRAND NEW 10" PHONO RECORDS—Ass't. Jazz—Pop—Hillbilly—Polkas.....\$1.79
 3 Ft. 5 Wire Shielded Cable with Amphenol Connection.....8 for \$1.00
 7 Wire Shielded Cable, 24 in. with Octal Plug.....6 for \$1.00

U. S. ARMY GAS MASKS

Has O.D. covered case suitable for lunch or tool bag and charcoal container for use in refrigerators to eliminate fish or other odors.
 Brand new—39c each; 3 for \$1.00

TRANSMITTING PLATE TRANSFORMERS

A pair of Signal Corps transformers connected in series to 110-125 Volts, AC, will deliver approximately 750 to 800 Volts, DC, 200 mls. when connected to a rectifier tube and filter condenser. Cost Uncle Sam \$23.00—our price per pair, \$2.98. Shipping weight 33 lbs.

Signal Corps Phones—2 M. Ohms (8 M. Ohms Imp.).....\$1.25
 2 Ft. Ext. Cord (and Plug).....40c

OIL FILLED FILTER CONDENSERS

1.-MFD—1000 working volts.....6/99c; 12/\$1.75
 CD. 4 MFD. 600 V. Upright Bottom Lug.....49c

TOBE TUBULAR ELECTROLYTICS

20-20 MFD. 150 V...35c 30-30 MFD. 150 V...37c
 40-40 MFD. 150 V...39c

Low-Loss Short Wave
 Lock Type Air Trimmer
 Variable Condensers

3 GANG T.R.F. VARIABLE CONDENSERS
 .000365 Con. 65c

3 Pl.—12-15 Mmfd...12c
 7 Pl.—25-30 Mmfd...15c
 8 Pl.—30-35 Mmfd...16c
 10 Pl.—40 Mmfd...17c
 14 Pl.—56 Mmfd...24c
 20 Pl.—80-100 Mmfd...28c
 27 Pl.—100-110 Mmfd...35c



D.P.D.T. SLIDE
 24c
 TOGGLE SWITCH...15c

4 PR. WAFER SOCKETS—\$1.49 per C. each...3c
 PHILCO 4 MF—300 V—1 3/4 CAN CONDENSER—10c ea.
 5-6 PRONG WAFER SOCKETS.....\$2.50 per C
 100 ASST. SOCKETS—4-9-6-7.....\$3.50 per C
 1,000 OHM WIRE WOUND POTENTIOMETER.....15c
 30 HY-FILTER CHOKE SHIELDED.....3 for \$1.25
 UNSHIELDED.....3 for 1.00
 2,000 ohm Wire Wound Rheostats.....\$1 per doz.
 CARTER WIRE WOUND C.T. VARIABLE 20 OHM
 RESISTORS.....85c per doz.
 RCA 6 OHM POWER RHEOSTATS.....19c; 7 for \$1.00
 GEN. ELEC. WESTINGHOUSE, etc., 60 CYCLE WATT
 HOUR METERS, slightly used, perfect condition,
 same as used in your home. 110-125 volts.
 5 Amps. \$2.95; 10 Amps.....\$3.95

PIEZO CRYSTAL HOLDERS with cover...12 for \$1.00

Grind your own crystals—Pure Brazilian Quartz, all sizes and thicknesses—1/2 lb. package.....\$1.00

RCA Band Switches—3 gang, 3 pos. 3 band.30c 6 gang, 5 pos. 4-5 band.40c

Trimmer-Padder Ass't.—all isolantite—singles, dual: triples—100 asst. pieces.....\$2.25

5"—450 ohm AC-DC dynamic speaker.....\$1.35

ATTENTION: Prospectors, Explorers for Hidden Treasures! Construct a U.S. Army Type of Metallic Mine Detector Amplifier. Amplifier unit only (less tubes and batteries) with cables, headphone cord, and jack. Army wiring diagram. Type AN/PRS-1.....\$1.95

RCA Ass't Mica By-Pass Cond. .001, .002, .0025, .100 for.....95c
 8 or 9 Gang Push Button Switch.....59c

DRILLED CHASSIS FOR 5-6 tubes 5"x10"x1 1/2". .25c
 PHONE JACKS—OPEN & CLOSED AUTO.....18c
 NATIONAL 20 MFD—450 VOLT CAN FILTER CONDENSER.....25c
 ERY SPEAKER VOL. CONTROL—60 OHMS.....15c
 SALE—PHONO RECORD ALBUMS—12" comp. 15c; 10"—3 comp.—15c; 4 comp. 20c; 12 comp.—49c

WESTERN ELEC. 20 AMP RETARD CHOKE, Wt. 125 lbs. Freight Shipments Only. SPECIAL.....\$5.00

4 Wire Shielded Cable, 6 Ft. with Plug...7 for \$1.00

IRC—300 Watt—300,000 OHM Wire Wound Res. 95c

6 Prong Amphenol Sockets.....\$4.00 per C

AMERTRAN FILAMENT TRANSFORMER—6.3 V. 10 Amp. Encased Isolantite Terminal Posts.....\$1.50

AMERTRAN XMITTING AUDIO XFORMER—For Class B or Modulator, Pri. 6400/1600—Sec. 5560 @ 160 MA. Cost \$75.00.....SPECIAL \$2.49

AMERTRAN AUDIO OUTPUT XFORMER—Pri. 10,000 @ 15 MA; Sec. 300, 6-1 Ratio.....\$1.49

AMERTRAN MIXER AUDIO XFORMER—Pri. 600-10,000 Ohms.....\$1.00

156-1 RATIO VERNIER DIALS—4 in., 3/8 in. Hub.35c

LINE VOLTAGE NOISE ELIMINATOR—Plugs in Between Radio and Elec. Socket.....35c

NATIONAL VELVET VERNIER DIAL—1/4 in. Hub, 4 in. Diam. Silver Plated.....\$2.15

12 in. MAGNAVOX SPEAKER, 2500 Ohms.....\$2.95

BY-PASS COND. ASST.—25 Cans, Bake., Paper, etc.....\$1.00

MINIMUM ORDER \$2.00—NO C.O.D.

SHIPMENTS—PLEASE INCLUDE POSTAGE

NEWARK SURPLUS MATERIALS CO.
 Dept. NC
 324 Plane Street NEWARK 1, N. J.

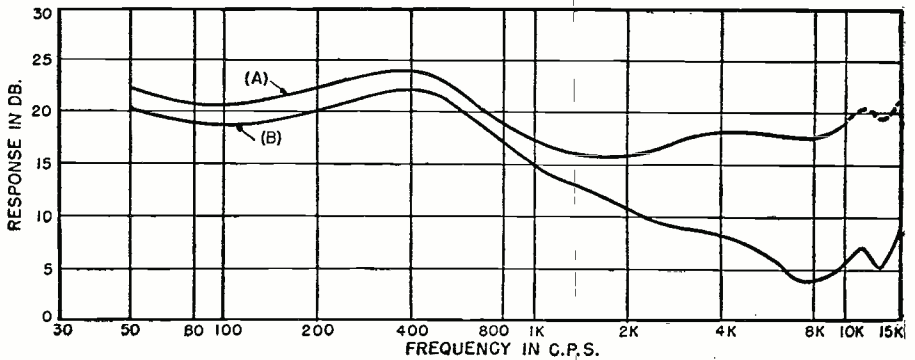

Fig. 16. (A) Response frequency characteristic of the wide-range pickup combined with recording response frequency characteristic. (B) With a standard test record.

45 r.p.m. records with the complete system, it is necessary to provide a small amount of frequency response compensation in the amplifier.

The potentiometer or volume control in the record player should be disconnected and the output of the crystal pickup connected directly to the amplifier through low capacity cable.

The needed compensation is achieved by resistors R_1 and R_2 in combination with condenser C_1 . For the LC1A loudspeaker R_1 and R_2 are each 510,000 ohms and C_1 is 50 μ fd. For the 515S1 loudspeaker R_1 and R_2 are each 270,000 ohms and C_1 is 300 μ fd.

Using the proper compensation the over-all response frequency characteristic of the system using the RCA LC1A loudspeaker is shown in Fig. 17 as is the over-all response frequency characteristic using the RCA 515S1 loudspeaker.

Tanglewood Demonstrations

The Festival Series of RCA radio, phonograph and television instruments (mentioned in Footnote 7) were first shown and demonstrated at Tanglewood, Massachusetts on July 29, 1947. In order to demonstrate the fidelity of these instruments, the reproduction of the instrument was compared with the full symphony orchestra. The Shed at Tanglewood in which the demonstration was conducted is an immense structure being 239 feet in length, 200 feet in width at the rear, and 40 feet in height. The microphones for recording the sound were located at the front of the stage. When the recording was made, the sound level was measured in various portions of the Shed, so that the level of the reproduced

sound would match the sound produced by the orchestra. A record was made of a piece played by the Boston Symphony Orchestra. Twelve RCA LC1A loudspeakers, placed at the front of the stage, were used to reproduce the orchestra. In the demonstration, the Boston Symphony Orchestra played the first portion of the selection and then, suddenly the switch to the record was made without interruption in the music and the remainder of the selection was reproduced. Dozens of music critics from several large cities stated in their newspaper and magazine columns that it was scarcely apparent where the live orchestra left off and the reproduced music began. This was due to the fact that the instruments reproduced both the tonal and volume ranges of the orchestra. The frequency range of reproduction was 30 to 15,000 cycles. With the twelve RCA LC1A loudspeakers, these tests showed that it was possible to duplicate the frequency and volume ranges of the orchestra.

New Speaker Model

Since the preparation of this article, continued engineering work on the application of the duo-cone principle has resulted in improvements in the design and manufacture of duo-cone speakers. A new model, the RCA 515S2, incorporating these improvements has been announced recently by the Tube Department of Radio Corporation of America. The amplifier and compensation for the RCA duo-cone loudspeaker 515S1 described in this article also applies to the RCA duo-cone loudspeaker 515S2.

-30-

Fig. 17. Over-all response frequency characteristic of systems using the LC1A and 515S1.

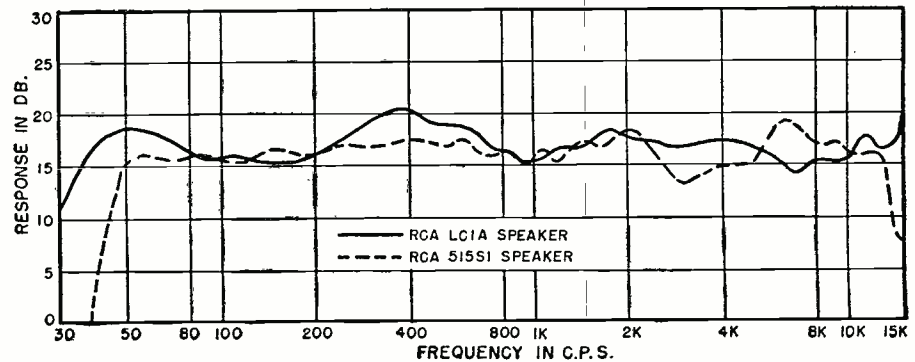

Recording Amplifier

(Continued from page 47)

was necessary because of short leads—was grounded to the bus at one end only and the shield was insulated from the chassis with Scotch tape at any point where it was likely to touch.

The large cathode condenser in the first stage of the playback amplifier was also a hum minimizing measure. The main source of hum at this point is emission from the heater of the tube. The use of a large condenser here helps bypass this source of hum to ground. The filament circuit was shunted by a 20 ohm center-tapped resistor and the center tap was grounded to the bus. In some cases the same result can be had by grounding the center tap of the filament winding, but often the use of the resistor gives closer control of hum.

It will be noted that the filaments of the recording channel and the plate supply for this channel are disconnected through a d.p.s.t. switch when that channel is not in use. This eliminates a heavy load on the power transformer and lowers the heat generated in the amplifier when only one channel is needed. A separate pilot light is used for each channel so that one can tell at a glance whether or not each channel is on.

Operation

The operation of the completed amplifier is very simple. The output from the recording channel is connected to the recording head; the playback head is connected to the input of the play channel and the microphone and phono to their respective inputs. If it is desired to monitor the recorded material right from the tape, all that is necessary is to turn up the playback volume control while the recording process is going on. Adjustment is usually made most easily if an audio oscillator is available. If not, a radio tuner may be connected and the adjustments made "by ear."

Some power transformers give output voltages considerably in excess of that expected. With the playback amplifier in operation, the plate voltage on the 6V6's should not exceed 300 volts. If the voltage is in excess of this value, a 10 watt resistor should be added in series with the lead to the center tap of the output transformer. Usually the proper resistor will be about 1000 ohms. The center tap of the output transformer should be bypassed to ground by means of a 10 μ fd., 450 volt electrolytic condenser if this resistor is used.

First, the proper recording level should be determined by experiment. It will be that level at which the recorded signal is considerably above the background noise on the tape, but at which there is a minimum of distortion. The volume indicator needle should swing about $\frac{3}{4}$ scale at this level. If it does not, R_{49} should be

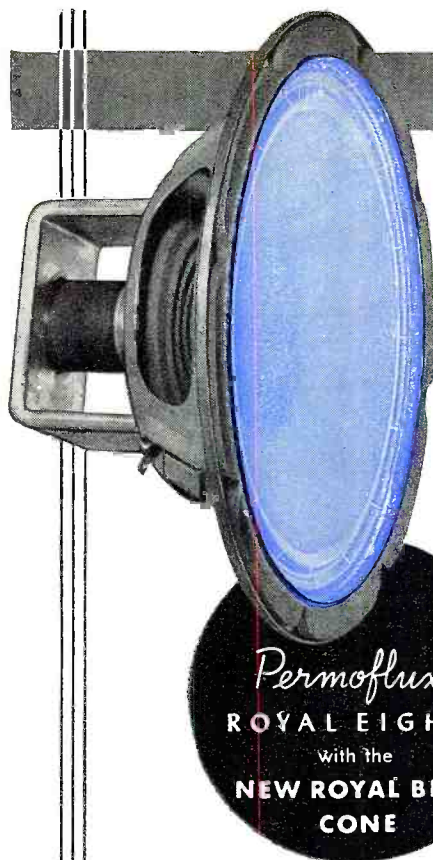

new

Permoflux
ROYAL EIGHT"
compares with
any 12" speaker!

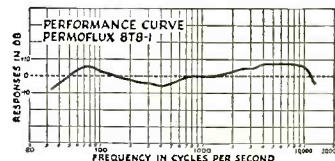

This averaged laboratory response curve of the Permoflux 8T8-1 proves that it compares with the finest speakers regardless of size or price.

It's Your "Springboard" to Extra Sales with Customers who want 12" performance but don't want to pay a 40% higher price.

From the resonant boom of jungle drums to the light warble of the flute, this new 8" speaker reproduces sound with superior sensitivity and fidelity. The tonal qualities of this magnificent speaker can only add to the excellence of any audio equipment.

Special processing provides extra-strong cone; allows cone to be soft-suspended from basket and held at coil-end by extra-large spider. Permits more faithful reproduction at lower frequencies. Deeper, curvilinear cone greatly extends high-frequency response.

Permoflux Royal Eight" (Model 8T8-1) is ruggedly-built, and simple to install. Provides big speaker performance in a small frame—uses smaller, more economical baffle. List Price \$15.00.

Send for Catalog No. J 201—Dept. TE

TRADE MARK
PERMOFLUX[®]
"SOUND IN DESIGN"
PERMOFLUX CORPORATION
4900 W. GRAND AVE., CHICAGO 39, ILL. • 236 S. VERDUGO RD., GLENDALE 5, CALIF.

SCHEMATICS—CONVERSIONS FOR SURPLUS GEAR

NEW LIST! MANY ADDITIONS!

Send stamped, self addressed envelope for List B. Add 25c for chart explaining AN nomenclature.

R. E. GOODHEART 345 1/2 N. PALM DRIVE
BEVERLY HILLS, CALIF.

630 TV CABINETS
FULL CONSOLES \$39.95
HALF DOOR AND FULL DOOR
In Mahogany—Walnut—Blonde
FOR PICTURES AND SPECS ENCLOSE 10c
IN STAMPS OR COIN TO COVER MAILING
JACK CANTOR, 74 Cortlandt St., NYC

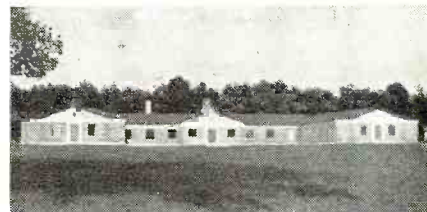

RADIO ENGINEERING TELEVISION ELECTRONICS

Thorough training in all phases of radio and electronics, open to high school and junior college graduates. Old established school specializing in Radio training exclusively. Modern laboratories and courses. Enrollments limited. Approved veteran training.

VALPARAISO TECHNICAL INSTITUTE
Dept. RD Valparaiso, Ind.



NOW
A
HIGH GAIN
ALL
CHANNEL
ANTENNA

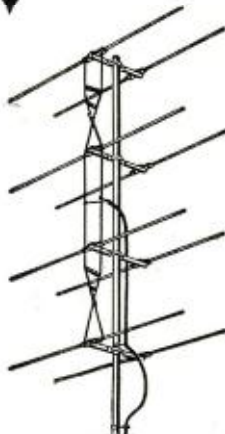

for only

\$23.75
LIST
LESS M&S

THE GREAT NEW
COLINEAR ARRAY
COMPLETELY PRE-ASSEMBLED

Think of it . . . a 4 bay, all-channel array built to Vee-D-X standards of high quality . . . yet only \$23.75 list. Pre-assembled for fast, easy installation, the Colinear Array (CA-7-13) is of super strength all aluminum construction, assuring permanency and eliminating wind noises. Sharp horizontal directivity and high gain make it ideal for multi-channel areas. The CA-7-13 can be cut for any high channel (7-13).

LaPOINTE-PLASCOMOLD CORP. 3
Unionville, Conn.
Please send me more information on the Colinear Array (CA 7-13).
Name _____
Company _____
Street _____
City _____ Zone _____
County _____ State _____

changed until this condition is brought about.

Next, bias intensity should be checked. Record a portion of tape and rewind it. Then run part of the recorded tape through the machine again with the machine turned on, but with the volume controls at the "off" position. Then play back the whole section of tape on which this trial run was made. If the bias voltage is correct, the portion of tape which was run through the second time will have the high frequencies partly erased, but the signal will be quite strong. If the signal is greatly diminished, the bias is too high and C_{25} should be replaced with a smaller size.

Different heads have different frequency responses, and it may be necessary to adjust the equalizing circuits, as mentioned earlier, to compensate for the differences in different heads. The values given here worked out very nicely for the *Indiana Model TD-704* record-playback head, available from the *Indiana Steel Products Co.*, Chicago 6, Ill.

It should be noted at this point that if the experimenter is using two heads—a separate recording and playback head—it is necessary to have some sort of "azimuth control." That is, provision must be made to turn the heads so that the gaps in the two are exactly parallel. If these gaps do not cut the tape at exactly the same angle there will be loss of highs. Usually it is most convenient to have the recording head stationary while the playback head can be tilted until the proper adjustment is made. This can be done very nicely by monitoring as you are recording and adjusting the playback head for best high frequency response.

This amplifier was designed principally for high impedance tape heads, but it will be noted that the oscillator coil has a low impedance winding which will supply bias to a low impedance head while audio can be supplied to such a head through an output transformer. This makes the amplifier easily adaptable for use with low impedance heads.

No erase voltage is supplied by this amplifier, the author having planned to use PM magnet erase which is simple and gives very good results with today's high quality tapes. However, erase voltage may be obtained by adding an amplifier stage following the oscillator, or by utilizing the voltage from the low impedance winding of the oscillator coil, depending upon the type of erase head used.

The unit is housed in a cabinet made of 1/2" plywood, fastened together with screws, and covered with a plastic covering similar to that used on luggage. The back is left open for ventilation and small rubber feet placed on the bottom eliminate the possibility of scratching any surface upon which the amplifier may be set.

The experimenter will find that this amplifier will give high-quality amplification at moderate cost. —30—

What's New in Radio

(Continued from page 102)

eye, and pilot bulbs. There is a spare socket provided in order to accommodate future design tubes. The tester also has an illuminated gear-driven "Speed Roll-Chart," two grid caps, a



protective overload bulb, a vacuum tube rectifier, and a full-vision bakelite-cased meter.

The kit comes with all the required components and complete, simplified assembly and operational instructions. The display case is available separately or the entire unit is available factory-wired as the Model 625-C.

SWITCH TIMER

A new electric switch timer for radio and television set installations is currently being offered to the trade by *The Sessions Clock Company* of Forestville, Conn.

The new unit has a square bezel of polished brass with color-filled etched numerals. The bezels have been made

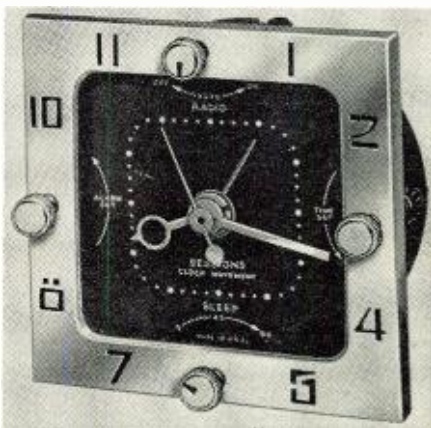

to meet a specific need for square design in TV and radio clock combinations.

For complete information on this new line write Department 16 of the Timer Division of the company.

NEW SOLDERING GUN

Weller Electric Corp. of Easton, Pennsylvania, has developed a new soldering gun which is equipped with dual spotlights to eliminate shadows and over/under terminals to brace the tip and improve visibility.

This new model is considerably

RADIO & TELEVISION NEWS

YOU'LL THANK US AGAIN AND AGAIN FOR THESE WONDERFUL BARGAIN VALUES



CONICAL ANTENNA



Latest model fan type conical with reflectors. Better on every channel, but superiority most terrific on higher channels. Much better than ordinary conical antennas. \$6.95 each. In lots of 10 \$60.00. Order #6491.

FOLDED DIPOLE ANTENNA



Full size folded dipole with reflector and mast. Stand-off insulators included. \$6.75 complete. 10 for \$60.00. Order #6430.

WINDOW ANTENNA



Highest quality telescoping folded dipole antenna with all the features usually expected in such an antenna, including use as a dipole and reflector, and in addition a mounting bracket provided so that the antenna can be installed in any window in two minutes or less. Any slight loss in gain because of the reduction from rooftop height is more than compensated by ability to orient antenna instantly by opening window and adjusting for maximum signal strength. Mounting bar can be installed horizontally or vertically in window frame or even between attic rafters, whichever is most convenient. Your cost \$7.00. With high frequency attachment for channels 7 to 13 \$9.00. Either type 10% less in dozen lots.

TWIN LINE

We will supply our antenna customers with scarce 30 ohm line at \$24.00 per M or \$2.50 per C (prices subject to change with the market) at a maximum rate of 100' per antenna purchased.

21 STRAND CABLE

Sensational Super Strength Stranded Cable at a MIRACULOUS saving. 350 lb. test. 21 Strands, overall diam. 1/32". Twisted in such a way that the cable will resist snarling. Alloy brass plated to resist corrosion. Use for antenna wire, guy wire, captive balloons, dials cable, etc. 6 cables stranded together (slightly over 1/16" total diameter) make an auto tow rope that will lift a ton. While the supply lasts 1000 ft. reel \$2.50, 5000 ft. spool \$10.00.

FCC AUTHORIZES RADIO FOR PRIVATE SERVICE!

In the "Citizen's" band neither code test nor technical knowledge is necessary. Brand new General Electric 12 Tube Transmitter set. A cinch for any experimenter to connect this unit for 110V AC operation from the electric outlet. All diagrams supplied, which cover numerous applications, including television. For those intending to use on car or boat a new dynamotor, exactly as originally supplied costs only \$15.00. Don't fail to write for descriptive bulletin. Order our RT-1248 for only \$29.95 or two for \$53.90.

DELUXE AC-DC RADIO KIT

High quality standard production line RADIO in kit form with complete instructions. No other advertised regardless of price offers these features. 2 non-core I.F. transformers. Polyethylene insulated edgewise-wound antenna loop. 2-rang condenser. Tubes include 12A76, 12BA6, 12BE6, 50L5, and 35W4. Receives Broadcast Band from 550 to 700 KC. Kit for \$17.00. Assembled, wired and tested, \$24.95 or 2 for \$25.00.

STROMBERG CARLSON—Power Switching Relay Box. Neat 3/2x4x5 1/2" Steel case with tight fitting cover finished in Stromberg's usual beautiful chocolate color crackle finish—25c.

WE CAN MAKE IMMEDIATE DELIVERY ON THE FOLLOWING TUBE TYPES IN REASONABLE QUANTITIES.

2A5	\$1.10	6J5	\$0.90	12SL7	\$1.40
2X2	1.50	6J6	1.74	2680
5V4	1.44	6K699	2780
5Y375	6K799	32L7	1.50
5Z3	1.08	6L6	1.60	50	1.25
6AC7	1.74	6R7	1.59	5685
6AJ5	2.34	6SA799	7689
6AK5	2.34	6SC7	1.20	7789
6AK6	1.44	6SD7	1.40	7880
6B7	1.50	6SF590	8069
6C480	6SK780	8490
6C6	1.20	6SQ775	85	1.05
6D699	10 or 210	1.25	117L7	2.34
6F7	1.73	12AT690	9GP7—9" scope or picture tube	\$7.95

Many of the above are JAN tubes. Manufacturers quantities on some of the above. No price reduction while present shortage lasts.

SCR-522
SCR 522 Transmitter-Receiver, approved by Government for taxicab use and other operation by unlicensed personnel. Special \$75.00
New PE-98 dynamotors to run the above 29.50
PE-94 dynamotors to run same, only 10.00

All Purpose Neon Tester
60 to 550 volt. Indicates all kinds of current, AC, DC or RF, and comes complete with instruction booklet outlining various tests on radio sets, including the location of fading, dead stages, shorts, and making screen-grid and plate circuit tests. 35c ea. Per doz. on attractive display card—\$3.50.

SPAGHETTI

Terrific Bargain in Spaghetti at lower than carload lot prices. Plastic Spaghetti made to U. S. Air Force Specs. Sale for 10,000 volts.
5 1/8" to 3/4" diam. 1c per ft.
5 1/8" to 3/4" diam. 1 1/2c per ft.
7/16" to 1/2" diam. 5c per ft.
1" 10c per ft.
We can supply continuous lengths up to 100' clear or black in most sizes.

SUPER SCOOP

All Rider Manuals and other Rider Publications 20% off the regular wholesale prices while quantities last.

The Radio Amateur's Handbook

(The Biggest Bargain in Radio Literature)
24th Edition \$1.00 26th Edition \$1.50
25th Edition 1.25 27th Edition 2.00

LINE FILTERS

Type "A"—Each unit contains two 4 Mfd. oil filled condensers and a high inductance 30 Amp choke in fully shielded case. Suitable heavy current connectors are provided to attach to the input and output connectors at each end of the filter from your input and output wires. A filter with innumerable uses on oil burners, refrigerators, boats, automobiles and wherever noise is to be suppressed or interference abolished. A \$17.00 value for \$2.98.

Type "B"—Heavy duty line filter consisting of 2 condensers and R. F. choke in plated steel case. Conservatively rated at 4 amps and 600 volts. Perfect for refrigerators, oil burners, power supply input of signal generators or to block out almost any interference you can think of. Super special \$7.50 each or 10 for \$5.00

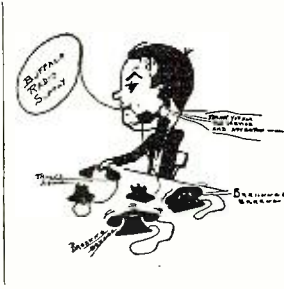

SPLATTER CHOKES

These Tapped "Splatter Chokes" are used between Class C stage and Modulator to eliminate objectionable side band splatter. DC resistance 50 ohms. Our Part No. 8860. \$1.00.

MIKE JR. 60c LAPEL MIKES—(Specify whether carbon or magnetic) 93c

COMPRESSED AIR INSTANTLY ANYWHERE

Portable Air Compressor and storage tank. Ruggedly built for industrial materials. Lifetime lubricated ball-bearing engine. Curved rod and oil-impregnated main bearing on shaft. Casual design forever eliminates valve trouble, the most common fault in air compressors. **PATENTED** unique air intake system increases efficiency tremendously so that air output is much greater than that from larger compressors powered by heavier motors. Delivers approximately 3500 cu. inches of air per minute at maintained pressure of 30 lbs., or will inflate a 90 lb. truck tire in less than one minute. Completed with 100 lb. gauge. Finger-tip adjustment allows setting of output pressure anywhere in the U. S. Efficient, completely adjustable siphon type spray gun complete with 12 ft. of 100 lb. tested hose, only \$7.75 with pint container, also prepaid.



WE WILL PAY CASH

for RADIO TUBES and for SCR284, BC654, PE103, BC348, BC312, BC222, BC324, and BC312 receivers, SCR522 and BC610 transmitters. We are especially interested in any factory, dealer or other outlet submitting a list of surplus electronic equipment for us to bid on.

Drillmaster Electric Drill

A Terrific Christmas Gift. (But our stock won't last until Christmas.)
Pistol Grip electric drill, ideal for hobbyists. Complete with sander, buffer, grinding wheels, etc. \$9.95

SIGNAL GENERATOR

Genuine Laboratory-type precision signal generator. Manufactured and sold for \$68.00 each in large quantities during the war by Northeastern Engineering Corp., one of the top manufacturers of electronic equipment for the U.S. Govt. Five fundamental bands starting at 150 KC. Strong harmonics up to 120 MC. Five step ladder type attenuator as well as potentiometer output control. Regular 1000 cycle audio oscillator using vacuum tube, not a cheap neon sawtooth audio oscillator. Audio output separately available externally. Weight without packing material 16 lbs. which should show what a world of difference exists between this signal generator and the ordinary cheap oscillator used by the average serviceman. Complete with fused plug and coaxial output lead. Super Special \$38.75.

HEAT GUN

Streamlined pistol grip heat gun. Vivid red housing. 20 cubic feet per minute blast of hot air at 160° Fahrenheit. Ordinary blowers have small fan motors, but this has a lifetime-lubricated AC-DC motor of the rugged vacuum cleaner type that produces a hurricane of either hot or cold air. Blow out dirt or dust from radio chassis. Dry out ignition systems. Heat carburetors. Quick-dry paint. Thaw out radiators or water pipes, etc. Warnings—Keep this away from your wife. She will use it to dry her hair because it will do it in half the time of her ordinary hair dryer, to say nothing of her using it to dry stockings or clothing, or defrost the refrigerator instantly. Only \$12.95. Satisfaction guaranteed or money refunded if returned prepaid within 5 days.



ASSORTMENTS

Wire Wound Resistors, 10 Asst., including adjustable \$1.00
Knobs, Assorted, 25 1.00
Sockets, 9, 8, 7, 6, 5 prong, 25 for 1.70
Coin Forms, all sizes, 20 Asst., for 1.00
Rotary Switches, Asst., 6 for 1.50
Resistors, Asst., 100 for 3.95
Insulators, Asst., 20 for 1.00
Bathub Oil Condensers, Asst., 6 for 1.00
Solder Lugs, Asst. Types, 300 for 1.00
Asst. Oscillator Coils, 7 for 1.00
Asst. Toggle, Push-button & Slide Switches, \$3.00 value, 5 for 1.00

CONDENSERS

Below is designated the quantity of nationally known tubular condensers that you can buy for a DOLLAR BILL.
*.0005-15 *.001, .002 or .005-11 *.01, .02 or .03-10 *.05-9 *.1-8 *.25-6 *.5-4.



PS THE NEW GUY WE HIRED TO SORT ALL THE BATTERY LETTERS OF THANKS FOR BARGAINS PURCHASED

BUFFALO RADIO SUPPLY, 219-221 Genesee St., Dept. RN-11, BUFFALO 3 N.Y.

New Edition



now 100 pages

Sun Radio's "Audio Equipment"

Our first edition of this free audio handbook was gobbled up immediately by sound enthusiasts who soon made it the standard guide for understanding and choosing high fidelity music components. One of our customers put it this way: "...this is the only book of its kind that really makes sense to a guy like me."

Now, here's our new, 1951 edition of the famous "Audio Equipment", completely revised and enlarged:

Again it contains an easy-to-read layman's guide to the understanding of high fidelity music systems written by an authority in the field.

In the catalog section you'll find everything: a complete, logical, easy-to-find listing of tuners, amplifiers, arms, pickups, speakers, record playing mechanisms and cabinets by every important manufacturer in the field.

Write for your copy-- absolutely free.

Visit Sun Radio's Famous Sound Studio

Push a few buttons on our famous selector panel and try various combinations of tuners, amplifiers, speakers, pickups. Let your ears be the judge and select the system you like from 2600 possible combinations. When you're in New York, stop in and visit our Sound Studio-- there's no obligation, of course.



9 to 6 daily, 9 to 4:30 Saturdays

smaller and lighter than previous models and has been designed specifically for radio and TV technicians, electricians, laboratory workers, etc. The gun features dual heat (100/135 watts) for all light and delicate sol-



dering, 5-second heating to save time and current, a trigger-switch control which adjusts the heat to the work and eliminates the need for unplugging the gun between jobs, and a chisel-shaped tip for faster heat transfer and speedier soldering.

Additional details in the form of a catalogue bulletin on the Model WD-135 are available on request.

CABLE TACKER

Especially designed for radio technicians, sound men, and juke box installers, the *Phillips Manufacturing Company* of Minneapolis, Minnesota, has recently introduced a cable tacker which may be operated with one hand.

Featuring concave center guides that instantly center both small and large cables, the new tacker securely and neatly anchors cables without damage to insulation. The unit handles staples of three different lengths ($\frac{3}{8}$ ", $\frac{1}{2}$ ", and $\frac{9}{16}$ ") and the amount of

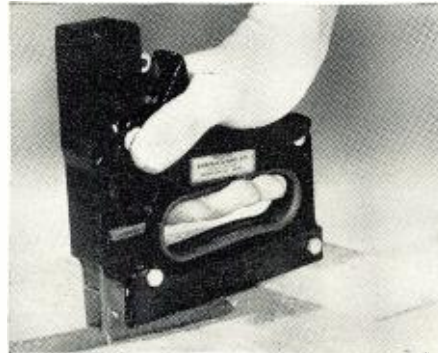

pressure applied to the tacker governs the depth to which the staples are driven. The tacker will handle from single conductor cables up to 30-wire multi-conductor cables of $\frac{1}{2}$ " o.d.

50-WATT MOBILE UNIT

A new 50-watt mobile combination for use in the 148-174 mc. band has been announced by the *General Electric Company's* Commercial Equipment Division, Syracuse, New York.

Designated the Mobile Combination 204, the new unit features a low cost tube complement, easily adjustable tuned circuits having triple-tuned transformers, and a new built-in low

Use **ERIE CERAMICONS**®

... as dependable replacements for molded mica and paper tubular capacitors



When you replace defective micas or papers with ERIE CERAMICONS you are guaranteeing customer satisfaction. Ceramics are the best dielectrics... ERIE CERAMICONS are the best ceramic condensers. Use ERIE CERAMICONS... they are made by the original ceramic condenser manufacturer in this country.

If your distributor cannot supply you, write us for information. New catalog on request.

Electronics Division
ERIE RESISTOR CORP., ERIE, PA.
LONDON, ENGLAND • TORONTO, CANADA

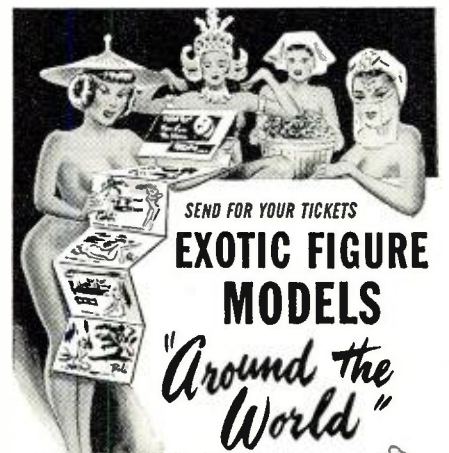

SEND FOR YOUR TICKETS
EXOTIC FIGURE MODELS
"Around the World"

TICKETS NOW READY FOR

"PACIFIC TO THE ORIENT"
HONOLULU • MACAU • SIAM
• BALI • TAHITI

"FAR EAST AND ASIA"
HONG KONG • SINGAPORE •
SAIGON • CALCUTTA • TEL AVIV

"EUROPE" FRENCH RIVIERA
• LONDON • PARIS • ROME •
SWITZERLAND

Alluring Figure Models - Actual Native Scenes
From the 15 Most Exotic Parts of the Globe

SEND 25c FOR SAMPLE COLOR SLIDE,
CATALOG and "YOUR TICKET"
... Specify "Pacific" "Asia" or "Europe"



WILLIAM H. DOOR

SUITE 1151 • 6208 SANTA MONICA BLVD.
HOLLYWOOD 38, CALIFORNIA

RADIO & TELEVISION NEWS

pass harmonic filter in the antenna output circuit which attenuates harmonics at least 70 db.

The receiver circuit elements provide better than 100 db. adjacent chan-



nel selectivity. Standby battery drain for the new unit is 11 amps. at 6.3 volts and transmitter drain is 60 amps. at 6.3 volts.

Complete details on this unit are available from the company.

MOBILE FM RECEIVER

Radio Apparatus Corporation, 310 Fountain Square Theatre Building, Indianapolis, Indiana, has developed a mobile FM receiver for the reception of all two-way FM telephone communications.

Known as the "Monitoradio," the new unit comes in two models. The M-51 is designed for the 30 to 50 mc. band while the M-101 covers the band from 152 to 162 mc. Both of these models are complete receivers. A specially designed whip antenna provides reception within a ten-mile range.

The units come in metal cabinets of gray hammertone. They each have



5 tubes plus a rectifier and a voltage regulator. The receivers are quiet under no-signal conditions.

SUBMINIATURE RELAYS

A new series of subminiaturized, anti-vibration, Series M relays has been announced by Neomatic, Inc., 879 Wellesley Ave., Los Angeles 49, California.

Developed to meet the exacting space requirements of manufacturers of radar and electronic components, the new relays measure less than $\frac{5}{8}$ x $\frac{3}{4}$ x $2\frac{1}{16}$ " and weigh less than $\frac{1}{2}$ ounce.

The relays are built to withstand 20 g. vibration and more than 50 g. acceleration in any direction without affecting contact position. The coil is universal wound and vacuum impregnated for long life. The solder lugs are widely spaced for ease in wiring the units into the circuit. Mounting is

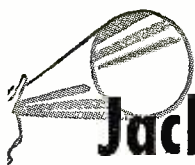

Announcing a NEW Jackson 5-inch Oscilloscope

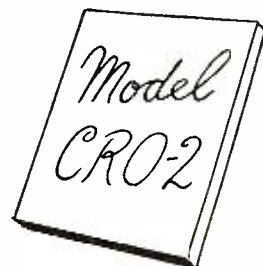

What's New . . .

Input Calibration Voltage—provides a standard for measuring unknown voltages. Vertical polarity switch allows you to reverse the polarity of vertical deflection voltage. New return trace blanking—all electronic—provides clearer, sharper image. New styling—helps you locate controls more quickly, matches Jackson Television Generator.

Plus All These Important Features . . .

Dual purpose vertical amplifier. Wide band, flat within 1.5 db, 20 cycles through 4.5 megacycles. Vertical deflection sensitivity .018 rms volts-per-inch. Saw tooth sweep, 20 cycles to 50 kilocycles. Intensity modulation, either 60 cycle or from external source. Direct connection through capacitors to deflection plates. Removable calibration screen. Many more important features.

See your distributor, or write

JACKSON ELECTRICAL INSTRUMENT CO.

DAYTON 2, OHIO

Represented in Canada by: The Canadian Marconi Co.

ALTEC'S..

#1

where
quality
counts!



Altec speakers remain the first choice of quality-conscious engineers and music lovers everywhere. The Diacone speakers, using a metal high frequency diaphragm plus a low frequency cone combine wide frequency range, exceptional fidelity and efficiency with moderate cost. They are ideal for multiple installations where quality is a must but where cost is still an important factor. Music lovers acclaim their smoothness of response...engineers their wide application.

15" 603B Diacone has multicellular horn-dispersion of "highs," power capacity of 25 watts. 12" 600B is ideal for smaller rooms where quality is required at lower power. Handles 20 watts. 8" 400B gives large speaker performance with small size. Handles 12 watts.

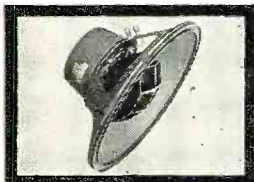

603B

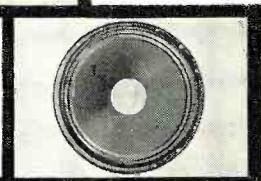

600B



400B

Send for brochure giving
complete technical data
on all Altec speakers.



1161 N. VINE ST., HOLLYWOOD 38, CALIF.
161 SIXTH AVE., NEW YORK 13, NEW YORK

accomplished with a single #2-56 screw and an extruded locating pin to maintain alignment. Precision adjustment of the operating value is provided. For insulation of the armature from ground, the relay is avail-

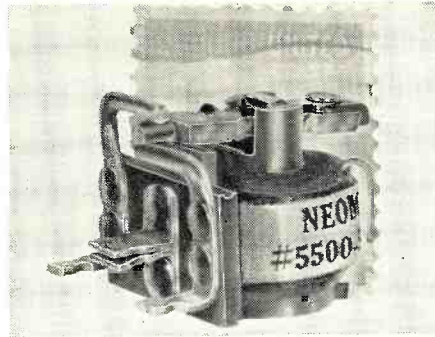

able mounted on an insulated base. Screw-type terminals can be furnished on the same base if desired.

A variety of coil and contact arrangements is available. For complete details write the company direct.

"SUPER SNIFFER"

Nuclear Instrument and Chemical Corporation of 223 W. Erie Street, Chicago, Illinois, has announced the availability of a new and sensitive Geiger counter which has been trademarked "Super Sniffer."

The instrument is an improved version of the company's "Sniffer" and features the addition of a flashing neon blinker light to indicate counts. The new unit is sensitive to both beta and gamma radiation and has a beta window to permit more careful checking of ores. Flashlight type battery loading simplifies this operation and a convenient belt clip on one side permits the instrument to be fastened to



the carrier's belt. A radioactive source is supplied with the instrument for checking purposes.

A data sheet on the new "Super Sniffer" is available from the company on request.

10-METER MOBILE ANTENNA

Ward Products Corporation of Cleveland 3, Ohio, has developed a new transmitting antenna for 10-meter mobile applications that requires just a single 1 5/16" mounting hole, thus eliminating the necessity of marring the finish of the car.

The Model SPP-143 is 55 1/2" long, the shorter length removing many of the hazards and possibilities of dam-

age inherent with the longer antennas when overhanging obstructions are encountered.

The new antenna is a modification of the company's SPPB71 unit which was designed for use as a detective car antenna. The rod assembly is designed to allow simple removal and replacement of the complete antenna rod in cases of non-repairable damage. Its ball and socket universal mount will fit any surface curving from between 35 degrees horizontal and horizontal. The female lead connection will accept commercial fittings for RG-8/U or RG-58/U coaxial cable.

NEW TIP JACKS

The *E. F. Johnson Co.*, Waseca, Minnesota, has designed a new tip jack which is said to offer longer life and better service.

In the new unit, contact is made along the entire length of the phone tip or test prod and remains unchanged despite insertion of an over-size tip, excessive binding forces, or long use.

These tip jacks are available in insulated style with molded Plaskon heads in ten colors. They are also

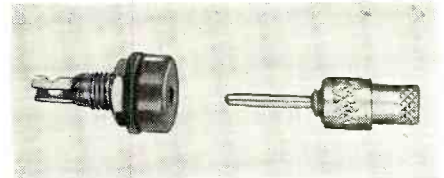

available without the head for mounting directly in equipment, as well as in a variety of other types.

Manufacturers are invited to write the company for free samples and catalogue information.

CONDENSER KITS

Erie Resistor Corporation of Erie, Pa., is currently offering its line of "Ceramicons" to radio and television servicing companies in plastic service kits.

The new packages are covered and transparent, permitting the technician to see at a glance what the kit contains. Three kits are being offered at the present time; one containing "GP" Ceramicons for bypass and coupling applications, one containing disc and plate Ceramicons used in television receivers, and a third kit containing the company's "NPO" zero temperature-coefficient Ceramicons.

NEW OSCILLOSCOPE

Jackson Electrical Instrument Co. of 18 South Patterson Boulevard, Dayton 1, Ohio, is currently offering a full five-inch CR tube in its Model CRO-2 oscilloscope recently introduced to the trade.

The wide-band vertical amplifier response is uniform from 20 cycles to 4.5 mc. The unit features high sensitivity, .018 r.m.s. volt-per-inch. The vertical impedance is 1.5 megohms, shunted by 20 μmf. The horizontal input impedance is 1.1 megohms.

RADIO & TELEVISION NEWS



THE HOME COLLECTION OF GREAT ART

Masterpieces

NUMBER 1 PRICE \$1.00



5 MILLION DOLLARS
IN ART TREASURES

175 OF THE
WORLD'S
MOST BEAUTIFUL
PAINTINGS

26 FULL COLOR
PLATES

PLUS:

Intimate biographical sketches of
the great masters.

PLUS:

Interesting, informative, text on how
to understand... evaluate... judge
art and discuss great paintings.

AT YOUR NEWSSTAND
NOVEMBER 3rd

NOW... ONLY \$1.00

MASTERPIECES is the greatest art publication value ever offered—anywhere. 175 of the world's most famous paintings—the best works of Raphael, Michelangelo, Titian, Rubens, Van Gogh, Picasso, Matisse, a hundred of the greatest Masters of all time—reproduced with every exquisite detail and glowing tone of the priceless originals.

Order your copy of MASTERPIECES now. On sale at your favorite newsstand November 3rd or send \$1.00 to

Masterpieces

185 N. Wabash Avenue

Chicago 1, Illinois

November, 1950

149

Get Service & Value at

ACORN



METERS

WESTON Model 731, 0 to 5 amps DC. White face, 3" square. **\$5.95**

WESTON Model 731, 0 to 1 amp DC. White face, 3" square. **\$5.95**

WESTON Model 741, 0 to 10 amps DC. Luminous dial on black face, 4" square. **\$7.95**

WESTON Model 741, 0 to 500 milliamps DC. Luminous dial on black face, 4" square. **\$7.95**

G. E. DC VOLTMETER—Type DO-41 0 to 300 v. 1000 ohms per volt. **\$3.98**

SIMPSON TUBE CHECK METER—0 to 1.4 milliamps. Scale gives complete tube check readings. 3 1/2" diameter. **\$3.49**

TV FLYBACK TRANSFORMERS

13.5 kv for voltage doubler circuit 16" tube 211T5. **\$3.95**

10 kv for 10" or 12" tube. 211T1. **\$1.95**

TV FOCUS COIL

470 ohm DC for 12 1/2", 16" and 19" tubes. **\$2.29**

630 TV CHASSIS 16" or 19"

- 30-Tube chassis keyed AGC—complete noise immunity
- Greater dynamic video range for superior definition and better picture contrast
- Full 4 megacycle overall picture band width
- 13-14 kv under normal picture load
- Unequaled performance in difficult reception areas
- 70 degree deflection to accept all shape tubes
- Armstrong FM sound system for noise-free and good quality sound
- Factory aligned—ready to play—complete, less CR tube



\$154.50

WESTINGHOUSE Type TD

Time Delay Relay

115v. 60 cy SPST glass enclosed adjustable delay 2 seconds to 1 1/2 minutes. **\$7.95**

APPROACH INDICATOR

(Glide path indicator)

1D-24/ARN-9. **\$4.95**

2" SPEAKER 4 OHM VOICE COIL

Self-contained transformer, nylon parchment cone—excellent for tweeter, can be used as mike. Made originally for handie-talkie. **\$2.29**

HEAVY DUTY POWER TRANSFORMER

Pri. #1: 110/220 v. 60 cy. Sec. #1: 410-0-410 @ 400 mls. #2: 6.3 v. @ 3 amps #3: 6.9 v. @ 13.5 amps. #4: 5 v. @ 3 amps. #5: 2.5 v. @ 1.7 amps. Dimensions: H-6 1/2" W-6 1/2" D-5 1/2". Wt. 33 lbs. Made by G. E. for U S Navy. Exceptional value! Open frame. **\$7.49**
3 for \$21

BEACON RECEIVER

BC-1206-CM

Made by Satchell-Carlson

Frequency range—195 KC to 420 KC IF Frequency—135 KC. Power supply 24-28 volts. Comes complete with 5 tubes. Includes instruction booklet. Brand New. **\$6.45**



*Due to conditions beyond our control, prices are subject to change.

TERMS: 20% cash with order. Balance C.O.D. All prices F.O.B. our warehouse in New York City. No orders under \$2.50.

Phone Worth 4-327D

ACORN ELECTRONICS CORP.

76 Vesey St. Dept. N-11 New York 7, N.Y.

The voltage calibration permits peak-to-peak voltage measurement of all waveforms. The switching arrangement provides vertical pattern reversal. A new electronic return trace blanking system has also been incorporated.

The sweep oscillator provides saw-tooth waves from 20 cycles to 50 kc.



in five steps. A sine wave sweep of 60 cycles is also available. The instrument has a removable calibration screen. A demodulation probe is available for use in signal tracing applications.

-30-

International Short-Wave

(Continued from page 79)

USA, OTM is still on 9.400 and *not* back on 9.380. (Stark, Texas, Bellington, N. Y., others) Still signs on 0000.

OTH, 9.21, Leopoldville, listed 15 kw., is coming in at 1200 in South Africa, usually in native program; OQ2C, *Radio College*, 4.98, usually is heard *only* 1130-1230 with musical broadcasts. (Hannaford)

Brazil—Current schedules being sent out by *Radio Jornal Do Commercio* are ZYK3, 9.565, 0455-1200, 1400-2100; ZYK2, 15.145, 0455-1400, and on 6.085, 1600-2100; *English* program "Brazil Calling" on 9.565 is weekdays 2005-2030, Sundays 1630-1700; QRA is *Radio Jornal Do Commercio*, Rua Marques do Recife, Recife, Pernambuco, Brazil. (Kroll, N. Y., others)

Radio Record, 9.605, Sao Paulo, is good to 2030 sign-off. (Richardson, D. C.) *Radio Nacional*, 11.72, Rio de Janeiro, noted 0410. (Bellington, N. Y.)

Radio a Voz do Oeste, Cuiaba, Mato Grosso capital, has just begun transmissions on 4.985 with 500 w. and call ZYZ5; m.w. outlet on 1160 kc. has call PRH3. *Emissora Continental*, Niteroi, State of Rio de Janeiro, will broadcast in the 60-m. band with 5 kw.; transmitter should be on the air this month or next. *Radio Difusora do Amazonas*, Manaus, still announces ZYSS on 4.805; heard 1608 with identification, location, frequency, and QRA given in Portuguese, French, Spanish, *English*, Italian, German, and what sounds like Swedish; in each language, asks for reports to Rua Joaquim Sarmiento No. 100, Manaus, State of Amazonas, Brazil. *Radio Cultura da Bahia* in Salvador, State of Bahia, will radiate on

STAY ON THE AIR WHEN POWER FAILS...with an ONAN Electric Plant



**AUTOMATIC
START & STOP**

Model 10EL, 10KW A.C.

When storms, floods, or fires interrupt electricity and force you off the air, you lose listeners and income. Guard against loss, assure vital public service during emergencies by installing an Onan Electric Plant. Onan Standby Electric plants serve many network and private stations. Automatic models to 35,000 watts.

PORTABLE ELECTRIC PLANTS FOR MOBILE RADIO USES



Supply A.C. power for broadcasting at scene of events. Can be carried by hand or in trunk of car. Weigh as little as 80 pounds. A.C. models 350 to 35,000 watts.

Write for **FREE Folder**



D. W. ONAN & SONS INC.
4809 Royalston Avenue
Minneapolis 5, Minnesota

HOW LONG WILL A CONDENSER LAST?

Frankly we don't know. Not because ours never go "west"—they occasionally do—but rather because the life of a condenser depends so much upon the type of service in which it is used, the quality of its associated components, whether it is being used conservatively or made to operate at maximum load, and things like that.

We have been making electrolytic capacitors for 16 years—literally millions of condensers have left ILLINOIS CONDENSER'S modern plant to go into electronic applications of all types. Every one of these condensers has one common characteristic—DEPENDABILITY.

This is the result of top-flight engineering, skilled, careful workmanship and the earnest desire on our part to make the finest, most reliable capacitors to be found.

Every capacitor made by ILLINOIS CONDENSER COMPANY is Unconditionally Guaranteed For One Full Year From Date Of Purchase.

There is a Guaranteed ILLINOIS CONDENSER for practically every electronic application. Write for new expanded catalog.



ILLINOIS CONDENSER CO.
1616 NORTH THROOP STREET - CHICAGO 22, ILL.

RADIO & TELEVISION NEWS

1010 kc. and 3.445 in the tropical band; first transmission is planned for December. A new station is being set up in Curitiba, capital of Parana, to operate on m.w. and s.w.; the s.w. channel is being made possible by international agreement with Bolivia; station will be *Radio Campos Gerais*; more details promised soon. (Serrano, Brazil)

Bulgaria—Radio Sofia, 7.671, noted 1645-1700 with news; weak. (Cox, Delaware)

Canada—VED, 8.266, Edmonton, Alberta, usually gives this complete announcement every three hours—"This is VED, Edmonton, owned and operated by Northwest Territories and Yukon Trading System, Royal Corps of Signals." (Neeley, Oregon)

VE9AI, 9.54, also Edmonton, is strong signal in Oregon around 2115 but has bad QRM; news 2100; at present uses only 9.54 although still lists 6.005 as "night-time" channel. (Callarman)

CKFX, 6.080, Vancouver, British Columbia, heard with music 0145-0200, then news. (Cox, Delaware) CBRX, 6.160, also Vancouver, heard in Calif. around 1000. (Russell)

Cape Verde Island—CR4AA, 5.920, Praia, is good in Newfoundland 1530-1700 sign-off. (Peddle) Bellington, N. Y., who has heard this one on occasion, says the frequency is closer 5.895; clock chimes 1700, then off with "A Portuguesa."

Ceylon—Radio Ceylon, 15.12, is widely reported with good level throughout the U. S. now to 1205 close-down; BBC news relay 1100.

China—At the time this was written, Radio Peking still had news 0830 on 10.260, 15.054V; may be 0930 by now?

Sanderson, Australia, hears a Chinese station on 9.820 some days with news in Chinese 0700; old XGOE?

A Communist-Chinese outlet on 6.16 may be Shanghai; at times seems parallel with the outlet on 5.985, believed Shanghai, and which has had improved signal lately. (Balbi, Calif.) Balbi lists other outlets heard irregularly around 0800-0900 as 7.40 and 7.05.

Colombia—A new Bogota outlet on approximately 15.450 is heard to 2330 closedown; news in Spanish 2200 after three chimes. (Dary, Kansas) HJFB, 6.105, heard signing off 2230 with anthem, good level; HJDE, 6.145, noted leaving air 2330 with anthem, good signal. (Bellington, N. Y.) Stark, Texas, reports *La Voz del Norte* (Eso la Radio Cadena Nacional) at Cucuta on 4.870, goes past 2145; Stark comments that this country seems to be installing many new transmitters.

Costa Rica—TIPG, 9.615, San Jose, noted signing off 0000. (Russell, Calif.) TIFC, "The Lighthouse of the Caribbean," 9.645, signs off in English 0006; excellent level; states reports should be addressed to P. O. Box 1307, San Jose, Costa Rica, and will be acknowledged with a souvenir. (Whitman, Ill.)

CLEARER PICTURES

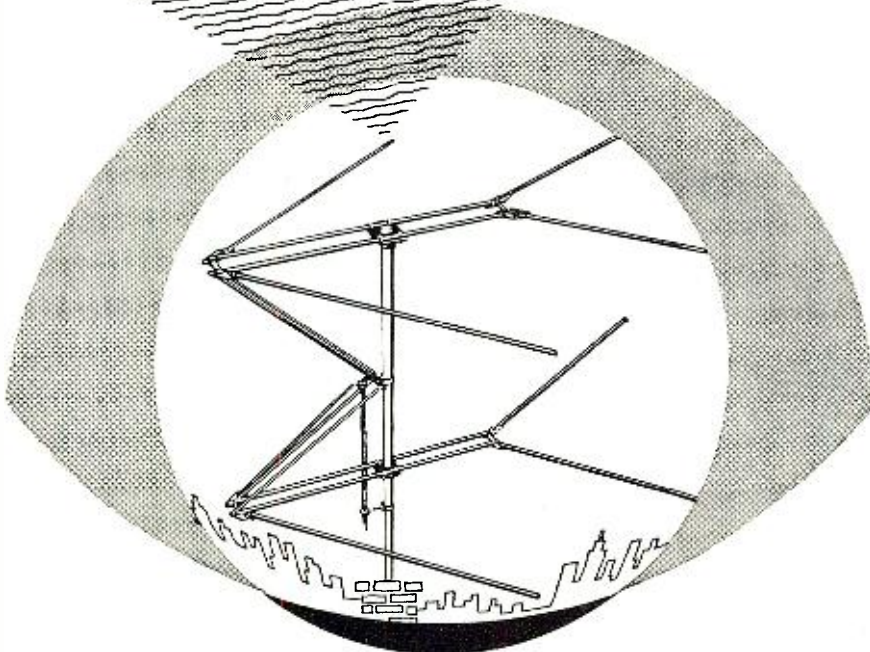

WORKSHOP

DUBL - VEE TV ANTENNA

PATENT PENDING

By applying the proven "end-fire" principle to TV antennas the WORKSHOP DUBL-VEE set the pace for 1950. Its quick acceptance — over 80,000 installed in three short months — is a testimonial to WORKSHOP'S acknowledged leadership in antenna design and engineering.

The DUBL-VEE is typical of WORKSHOP antennas in other fields — commercial, amateur and aircraft. In every instance, advanced engineering and outstanding performance have established ready acceptance. You know when you specify the DUBL-VEE, or any other WORKSHOP antenna, that you are getting the best.

Write for Bulletin A



TECH-MASTER

TELEVISION

De Luxe KITS from 19 inch to 10 inch with Keyed AGC

TECH-MASTER KITS are acknowledged by the radio industry as the finest for quality and performance. Avoid the danger of buying untested brands . . . insist on TECH-MASTER . . . indisputably the finest of them all. All components are factory mounted. Easy to follow instructions assure perfect performance in comparatively short time.

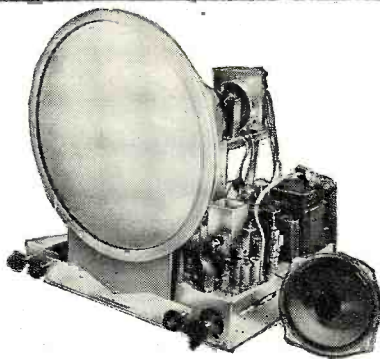

TECH-MASTER TV ACCESSORY KITS



Booster



"Hi-Sweep" VOLT-AGE MULTIPLIER.



KEYED A. G. C. CIRCUIT for 630-Type chassis.

Write Dept. RN for literature on complete TECH-MASTER line of Kits.

TECH-MASTER PRODUCTS CO.

443-445 Broadway, New York 13, N. Y.

More leading engineers and technicians have built Tech-Master for their own use than any other Television Kit.



Cuba—COBZ, 9.026, Havana, noted with BBC's *English by Radio* at 1800. COCH, 9.437, Havana, heard signing off 0000 with *English* announcement; said would return 0600. (Cox, Delaware)

Cyprus—Sharq-al-Adna's 6.170 channel noted signing on 2255. (Bellington, N. Y.)

Czechoslovakia—Prague has settled down to North America at 1900 on 15.23, 2100 and 2230 on 11.84, 15.32. (Fargo, Ga., Fried, Mich., others) Noted on 9.55 at 2345 with recordings; audible to 0020 when Paris brings carrier on air. (Sutton, Ohio)

Dominican Republic—A station reported by Cox, Delaware, on approximately 3.290 is HI2L, *La Voz del Tropicos*, Trujillo (formerly on approximately 9.525); goes past 2200. (Stark, Texas)

Ecuador—HC2AM, 7.350V, Guayaquil, noted with music 0000-0100. (Sutton, Ohio)

El Salvador—YSBR, 4.795, *Radio Tropical*, Neuva Santa Anna, is heard in Texas to after 2100; strong signal. (Stark)

France—*English* from Paris is 1345-1445 on 6.145, 6.200. (Radio Sweden)

French West Africa—*Radio Dakar*, 11.896 and 15.341, still has *English* news 1400 (by woman) daily except Sunday. Noted by Whitman, Ill., signing on the 11.896 channel 0200, excellent level.

Germany—RIAS, Berlin, will begin transmissions on s.w. at the end of this year, probably on 42 meters. (Radio Sweden)

Greece—"The Greek Armed Forces Radio Station" in Athens is under the supervision of the Greek General Staff. Broadcasts daily on 6.340 at 2330-0200, 0500-0800, 1100-1630; power is 200 w., soon to be increased to 1 kw. So far, reports have been received from Sweden, England, Venezuela, Australia; station officials state than an *English* program will be added soon for overseas listeners; this one is heard by Pearce, England, at 1345-1627 sign-off.

The Greek Army station at Kavala, 7.650, is now on the air until 1600; some sources say has changed frequency to 7.590. (Radio Sweden) Pearce, England, believes this one is now on 7.600; Kavala verified earlier report for him from Rokkos Toullos, Station Engineer, Radiofonicos Stathmos Enaplon Dimamen Anatol Make-donias S. Thakis. Kavala. Greece.

Guatemala—TGWB, 6.43, noted leaving the air 0005 with female chorus singing anthem; fair level in New York. (Bellington)

Haiti—4VRW, Port-au-Prince, more recently has been on 9.835 although still announces 10.135. Now signs off around 2200, sometimes with *English* announcement; asks for advertising to be given in French, Spanish, or *English*. (Leary, Indiana; Stark, Texas)

Holland—PCJ, Hilversum, has a new QSL card. (Herd, Delaware)

Honduras—HRN, approximately 5.975, noted with popular music 1942.

DO YOU HAVE B-A's 148 PAGE 1951 FREE CATALOG?



Complete Guide to the Latest Products of Top Makers in Radio, TV, Sound and Recording Fields

BURSTEIN-APPLEBEE CO.
1012-14 McGee St.
Kansas City 6, Mo.

FREE

Send me your 1951 Catalog.

Name.....
Address.....
City.....State.....

BURSTEIN-APPLEBEE CO.

OUTSTANDING - TV - VALUES

MODEL #300
Folded dipole complete with reflector and high frequency adapter. Covers 13 channels. All alum. construction. Less mast. Shpg. wt. 7 lbs. PRICE.....\$4.95

MODEL #200-D
Stacked array. Consists of 2 complete copicals and connecting bars. Very rigid construction. Covers all 13 channels. Matches 300 Ohm or 75 Ohm. Center impedance 150 Ohm. Ideal for low signal areas. An outstanding buy. Shpg. wt. 12 lbs. **SENSATIONAL \$8.75 OFFER** at less mast.

MODEL #200-S
Single array. Same construction as above. Shpg. wt. 7 lbs. Price, less mast.\$4.00

MODEL #500
All-band folded dipole antenna. Ideal for rotator use. Maximum gain on any channel. All alum. construction. Less mast. Shpg. wt. 8 lbs. Price.....\$4.95

MODEL #Y-100
5 element Yagi Hi-Gain beam designed specifically for fringe area use. All alum. construction. Cut to specific channels. Shpg. wt. 4 lbs. Channel 27, \$4.50; Channel 29, \$4.25; Channel 31, \$4.00; and Channel 33, \$3.75. The prices are less mast. "U" type antenna. Price \$4.25

ANTENNA ACCESSORIES

CM-100 Chimney Mount.....	\$ 1.50
WM-100 3" Wall Bracket.....	.50
WM-100 15" Wall Bracket.....	2.75
5-ft. 1 1/4" OD Steel Mast.....	.75
6-ft. 1 1/8" OD Alum. Mast.....	1.60
6-ft. 1" OD Alum. Mast.....	1.25
3 1/2" 300-ohm stand-off insulators (fit coax cable). Per 100, \$3.00; per 500, \$12.00;	
"U" Bolt Assemblies—ideal for most couplings.....	per 1000 20.00
Best Quality 300-ohm twin lead.....	per 500 5.00
High Quality 72-ohm Coax Cable.....	Send for prices.
Folded Dipole Hi-Frequency Adapters.....	1.35
Conical Hi-Frequency Adapters.....	1.50
Straight Dipole Hi-Frequency Adapters.....	1.25

TERMS: All shipments F.O.B. Newark, New Jersey. 25% deposit with orders, balance C.O.D. Minimum order \$2.00. Include ample postage.

EAST COAST ELECTRONICS
40 St. Francis Street Newark 5, New Jersey

(Cox, Delaware) Heard to 2330 sign-off. (Sutton, Ohio)

Hong Kong—ZBW3, 9.525, noted 0700 with BBC relay, weather report, warnings to ships. (Sanderson, Australia)

Hungary—At the time this was written, *Radio Budapest*, 11.910 and "claimed" 9.820 (actually around 9.8345) was being heard to Britain and Europe with news 1600 and 1815; and in new transmissions to North America (in *English* and Hungarian) around 1930-2030, 2300-2400. (Bellington, N. Y., Fargo, Ga., others) The 31-m. outlet is good on West Coast 2330-2400 while the 25-m. channel has some QRM. (Balbi, Calif.)

India—A "wavelength" schedule just in via airmail from AIR, Delhi, lists *English* periods as—2130 (news), 17.76, 11.83, 9.68, 9.565, 7.275, 7.225; 2315, 17.79, 15.16; 0230, 21.700 (*presumably a new outlet*), 17.78; 0300 (news), 17.76, 15.29, 11.83; 0530 (Sat., Sun. only), 17.76, 15.16; 0730 (news), 17.76, 15.29, 11.83, 9.68; 0830, 17.84, 15.35; 1030 (news), 15.16, 11.83, 9.68, 9.59, 7.225, 6.01; 1045, 15.13, 11.79; 1400, 11.76, 9.62, and 1930, 17.83, 15.16.

Indo-China—The 6.19 outlet has been heard announcing as *Radio Dalat*; French news 0745; "Voice of Vietnam," 9.62 and 7.265, has news 0900 lately. Recently, an outlet on 6.115 has been heard in parallel with Saigon's 6.165 channel 0730-0830; powerful signal; the 11.83 outlet remains weak. (Balbi, Calif.)

Iran—*Radio Teheran*, 15.100, is still sending a good signal to Eastern U. S. 1500 with news. (Fargo, Ga., others) Heard in parallel on 9.660 occasionally but is much weaker than the 15.100 frequency. (Cox, Delaware) Teheran verified reception of the Regional Unit on 0.404 (*now on 3.960*) and gave call as EPP; power not stated. (Cushen, N. Z.)

Israel—Tel Aviv is back on approximately 9.018 (announced 9.000) with news daily 1600 in broadcast of the World Zionist Movement from Jerusalem; tested on various channels but informed Pearce, England, that has settled down on 9.000 which seemed to give best results for listeners in the 31 countries from which reports on tests were received; at times has bad QRM and CWQRM here in Eastern U. S.

Tel Aviv's 6.83 outlet was noted recently opening 2230, poor level in N. Y. (Bellington)

Jamaica—*Radio Jamaica*, 4.950, operates weekdays 1600-2300, Sundays from 0800, according to verification. (Radio Sweden) May still use 3.480 at times. The 4.950 channel is being picked up in Sweden around 2000, according to Ohrwall.

Japan—JKL, 4.860, Tokyo, noted 0800 with AFRS news; good signal in Oregon. (Neeley) JKL2, 9.605, noted 0415 with variety program. (Sanderson, Australia) JKJ, 7.285, noted with 15-minute program in *English* (probably *English* lesson) at 0300, fair level in Calif. (Stein)

The Finer Recordings Are Made With SOUNDCRAFT Tape And Discs

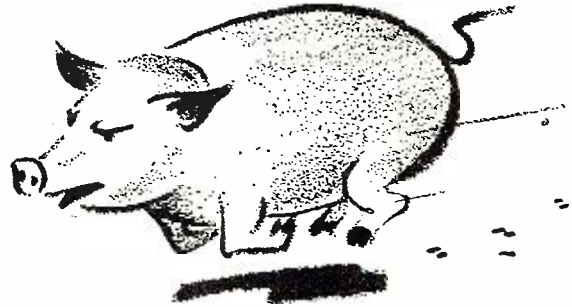

You are not buying a pig-in-a-poke when you specify **Reeves Soundcraft** for your recording needs.

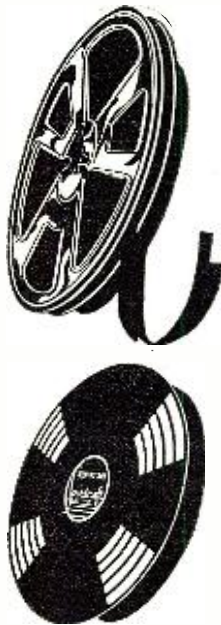

SOUNDCRAFT MAGNETIC TAPE. In all the qualities which determine tape performance, Soundcraft offers distinct improvement over standards of the past. Superior both electrically and mechanically, Soundcraft tape is limited only by the characteristics of the equipment with which it is used.

SOUNDCRAFT RECORDING DISCS. Long a network standard, Soundcraft discs today approach perfection in the field of recorded sound. Whether you record at 33 $\frac{1}{3}$ standard groove, 78, or 33 $\frac{1}{3}$ LP—you may be certain that Soundcraft discs will enhance your recording quality, at the same time effecting considerable economy.

Only by actually using Soundcraft tape and discs can you learn, to your own satisfaction, how greatly they can improve your recordings. Write TODAY for the Soundcraft story. Mail coupon below for FREE booklet. Do it NOW!

SOUNDCRAFT'S PROOF OF QUALITY LIES IN ITS PROOF OF PERFORMANCE

Dear Soundcraft:

Please send your recording media catalog.

Our favorite disc distributor is _____

Name _____

Address _____

REEVES — "20 YEARS WITH SOUND RECORDING MEDIA."

REEVES **Soundcraft** CORP.

35-54 36th STREET, LONG ISLAND CITY 6, N. Y.

EXPORT—REEVES EQUIPMENT CORP. • 10 E. 52ND, N. Y. 22, N. Y.

vantage of requiring in most designs that the stylus, cartridge and arm structures operate against a spring tension as they move inwards. This loads (biases) the stylus against the outside wall of the grooves and tends to produce differential wear as well as other undesirable effects.

In the *Lincoln* changer, mentioned previously, the trip mechanism functions entirely in terms of the diameter. In other words, when the stylus gets to a specific inside diameter on the record the changer mechanism is tripped and the eccentricity of the inside groove has nothing to do with it. The undesirable feature of this involves the fact that there is an appreciable difference between, for example, most 78 r.p.m. and most long playing records with regard to the inside diameter of the recorded portion of the surface. This means that it is necessary to adjust the preset tripping mechanism when changing from standards to microgrooves. In order to make it possible to adjust this for various in-between conditions, the control should be (and in this case is) continuously variable.

All of the considerations discussed involve the stylus, the pickup cartridge and the arm, and this is only an outline of the beginning of the chain of components in a music reproducing system. In common with many other technical subjects the problems of music reproducing systems seem at first complicated; then a block diagram of a record changer, amplifier, and loud-speaker makes them seem comparatively simple. Finally when a little knowledge brings realization of all the detailed problems, the engineer and the audio enthusiast seeking perfection recognize that there is no end to learning about this subject. That, of course, is why audio engineering is such an absorbing hobby or profession.

-30-

RCA's super-gain antenna atop the National Lottery Building, Mexico City, radiates the signals of Mexico's first TV station, XHTV. All equipment for this new station was supplied by Radio Corporation of America.

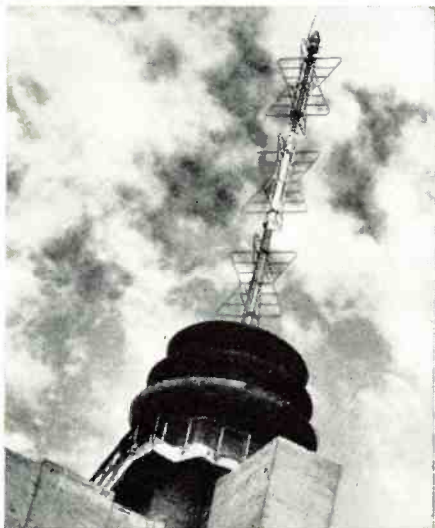

November, 1950

CHICAGO FULL FREQUENCY OUTPUT TRANSFORMERS

.2db 30-20,000 CPS

No. BO-6. For use in high fidelity amplifiers. Couples push-pull 6L6's (7500 ohms, C-T) to 6/8 or 16/20-ohm voice coil. Center-tapped tertiary winding provides 15% inverse feed-back to reduce harmonic distortion to a minimum. In drawn steel case, 4⁵/₁₆" x 3⁷/₈" x 3¹¹/₁₆", with mounting studs and convenient pin-type terminals.

No. BO-7. For matching 600 or 150-ohm line to a 6/8 or 16/20-ohm voice coil. Frequency response within plus or minus 1db. at full rated output—maximum power level, 30 watts. Mounted in compound-filled drawn steel case, 4⁵/₁₆" x 3⁷/₈" x 3¹¹/₁₆". Mounting studs and pin-type terminals same as No. BO-6 illustrated above.

There's a CHICAGO Output Transformer for Every Full Frequency Use

Cat. No.	Application	Impedance	Max. Power
BO-1	Single Plate to Line	Pri.—15,000 ohms at 0 to 10 ma d-c *Sec.—600/150 ohms CT	+20 dbm
BO-2	P.P. Plates to Line	*Pri.—20,000 ohms CT *Sec.—600/150 ohms CT	+30 dbm
BO-3	P.P. Plates to Line	Pri.—5,000 ohms CT *Sec.—600/150 ohms CT	+40 dbm
†BO-4	P.P. Plates to Line	Pri.—7,500 ohms CT *Sec.—600/150 ohms CT	+43 dbm
BO-5	P.P. Plates to Line	Pri.—10,000 ohms CT *Sec.—600/150 ohms CT; 16/8/4 ohms.	+37 dbm

‡Tertiary winding provides 15% inverse feedback. *Split and balanced windings.

HIGH Q CHOKES

for Dynamic Noise Suppression Circuits

Two precision-built chokes with inductance values of .8 and 2.4 henrys respectively—accurate to within + 5% with up to 15 ma d-c. Units have a minimum Q of 20. Remarkably compact, 1¹/₈" x 2³/₈" x 1¹/₈".

No.	Inductance
NSI-1	.8 h
NSI-2	2.4 h



Famous "Sealed in Steel" New Equipment Line

The units described above are typical of CT's New Equipment Line featuring transformer engineering that's ahead of the trends in circuit design. Get the full facts on the complete line now. Check the features, and you'll see why CT is called the "Engineer's Transformer." Check the prices: see how little more these advanced units cost over ordinary transformers.

Write for Complete "New Equipment" Catalog Today



CHICAGO TRANSFORMER

DIVISION OF ESSEX WIRE CORPORATION

3501 ADDISON STREET • CHICAGO 18, ILLINOIS

YOU CAN STILL
Buy—
TROUBLEPROOF
TELEVISION
THE 630 TV WILL WORK
WHERE OTHERS FAIL!

Own the Television Set preferred by more Radio and Television Engineers than any other TV set ever made! **THE ADVANCED CLASSIC 630 TV CHASSIS.**

With the latest 1950 improvements the 630 TV will out-perform all other makes in every way. The 30 plus tube circuit should not be compared to the cheaply designed 24 tube sets now being sold under standard brand names.

• **Greater Brilliance**

Assured by the new 14-16 KV power supply.

• **Flicker-Free Reception**

Assured by the new Keyed AGC circuit—no fading or tearing of the picture due to airplanes, noise, or other interference.

• **Greater Sensitivity**

Assured by the new Standard Tuner, which has a pentode RF amplifier and acts like a built-in High Gain Television Booster on all channels! The advanced 630 chassis will operate where most other sets fail, giving good performance in fringe areas, and in noisy or weak locations.

• **Larger—Clearer Pictures—for 16" or 19" tubes**

Assured by advanced circuits. Sufficient drive is available to easily accommodate a 19" tube.

• **Trouble-Free Performance**

Assured by use of the finest materials such as molded condensers, overrated resistors, RCA designed coils and transformers, etc.

• **RMA Guarantee**

Free replacement of defective parts or tubes within 90 day period. Picture tube guaranteed fully for an entire year at no extra charge!

PRICE COMPLETE, **\$159.50**
LESS PICTURE TUBE.....

EXTRA CLEAR PICTURE TUBES

Standard Brands

ONE YEAR GUARANTEE

12 1/2" (Black or White)...	\$21.00	Glass 16" Round (Black)	\$39.95
Glass 14" Rectangular (Blk.)	24.00	Glass 16" Rectangular (Blk.)	39.95

19" and 20" Tubes Available. Write for Prices.

TELEVISION CABINETS
16" Table Model Cabinet

A gorgeous table model cabinet for the average size living room. Outside dimensions 23 3/4" Wide x 24" High x 24" Deep.
Walnut or Mahogany..... **\$42.50**

16" Economy Console Cabinet

An exceptional buy in a console cabinet made of fine veneers to house the 630 TV chassis, tube and speaker. Outside dimensions are 39" High x 24" Wide x 22 3/4" Deep. **\$44.95**

16" DeLux Full Door Console

Gracefully designed to be one of the beauty spots of your home. Doors swing open to view television. Exquisitely finished. Outside dimensions 26 1/4" Wide x 41" High x 25".
Walnut or Mahogany..... **\$79.95**

16" Exotic Chinese Console

The distinctive beauty of the Chinese design cabinet makes it one of the most charming of our entire stock. The full doors conceal the TV set and controls. Outside dimensions 41" High x 26 1/4" Wide x 25" Deep.
Walnut, Mahogany or Ebony..... **\$117.50**

Protective Glass window for any above cabinets..... **\$2.25**

SPECIAL!!
THE NEW DOUBLE V TV ANTENNA
Price—Only \$4.95 Less Mast

5 Ft. Sectional Mast 95c

All Merchandise Subject to Prior Sale. All Prices Subject to Change without Notice.

WRITE FOR COMPLETE CATALOG N-II

EDLIE ELECTRONICS INC.

154 Greenwich St. New York 6, New York

Equalizing Preamp

(Continued from page 49)

able for introducing the output of either a phono preamplifier or an AM or FM tuner.

One peculiarity of the circuit is that the volume cannot be reduced to zero. This is caused by the resistor in series with the lower end of the volume control. The gain can be reduced, however, to a lower value than would be used for listening.

As in any amplifier which does not have the volume control located in the first tube's grid, overloading of the first stage is possible. Care must be exercised when connecting this unit to a tuner, for instance, so that the output of the tuner does not provide too great a signal voltage for the 6J7 input tube.

The easiest way to avoid such trouble is to advance this unit's volume control to maximum; then connect the tuner. Advance the tuner's volume control until the speaker volume is as loud as you will ever need. The unit will not overload under these conditions, and the volume can now be varied by means of the volume control, or if it has several audio stages, a potentiometer may be connected between the tuner and this unit temporarily. This control may be adjusted as desired and then replaced with two resistors. The value of the resistors will be the same as the resistance values measured with an ohmmeter between the temporary volume control's movable arm and each end.

As these resistors are used in a low level position, they should be placed with care to eliminate the possibility of hum pickup.

The unit should be adjusted at the level which the listener uses most. The variable tone controls may be set for the most natural sounding reproduction.

If the constructor desires to set up the unit in a scientific manner, the volume control should be set to the full position and an audio oscillator connected to the unit's input. The audio oscillator output should be adjusted at 1000 c.p.s. for a level of approximately 100 db. which is about half of full volume from a 10 watt amplifier into an average 15" speaker. The oscillator should be then varied from 30 to 15,000 c.p.s. All of the frequencies in this range should be heard at the same level. The two equalizer controls should be set so this condition exists. Then the volume control may be changed to a lower level, and it will be found that the entire frequency range is still audible at the same level.

Since loudspeakers have great difficulty in reproducing low frequencies at successively higher levels, due to restricted cone travel and inadequate coupling to the air, this unit acts to reduce low frequency distortion due to overload of the loudspeaker on low frequencies as the volume control is advanced. This unit, then, provides one more device which relieves the listener of mechanical manipulation so that he may be free to enjoy the program material he has selected.

—30—

Under chassis view. Note the tubes mounted on the rear flange of the preamp unit.

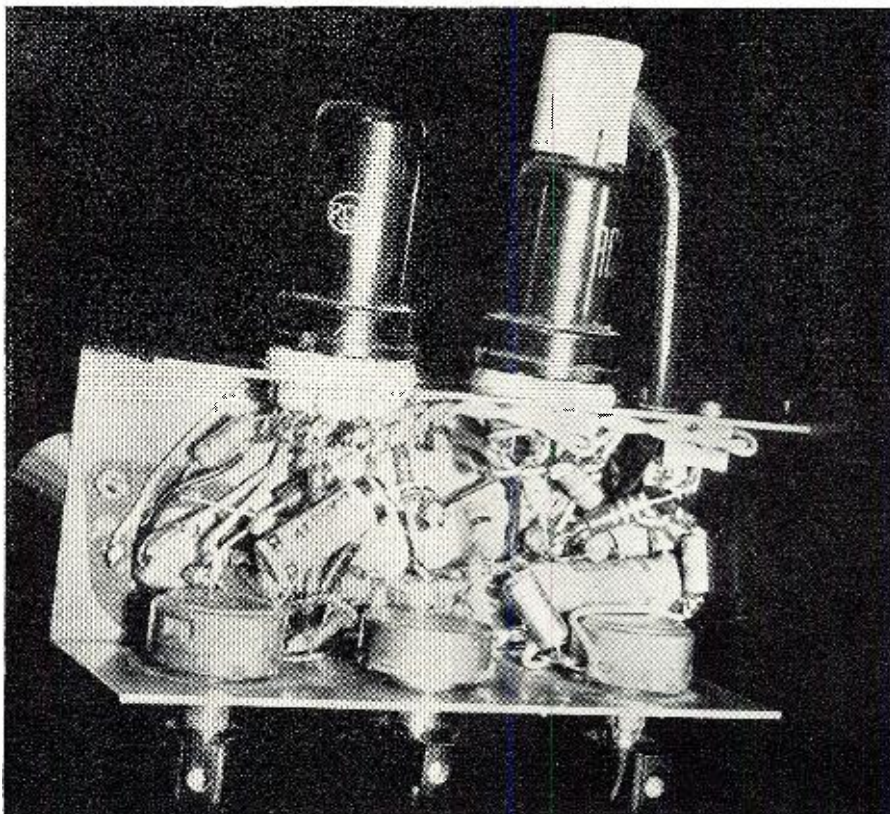

SAFE AT THE PLAT !



AND SO IS Seletron

SELETRON "Safe Center" plates in miniature rectifiers eliminate the danger of arc-over, short circuits and excessive heating due to high leakage current at the center contact point. Assembly pressure, or pressure applied in mounting the rectifier cannot affect its performance. This SELETRON feature is accomplished by deactivating the area of the plate under the contact washer.

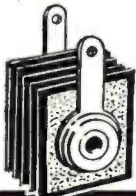

There are millions of SELETRON Selenium Rectifiers in service in radio and TV; millions more in other electronic circuits. That is why you can specify SELETRON and be safe!

Look for Howard W. Sam's Red Book Supplement listing SELETRON replacements . . . and write for your copy of our new Bulletin No TN-1

SELETRON DIVISION
RADIO RECEPTOR COMPANY, INC.
Since 1922 in Radio and Electronics
Factory: 84 North 9th St., Brooklyn 11, N. Y. • Sales Department: 251 West 19th St., New York 11, N. Y.

SAVE

THAT GOOD LOOKING OLD CONSOLE WITH THE OBSOLETE RADIO!

install a modern

ESPEY AM/FM CHASSIS

and your favorite console is "right-up-to-date"

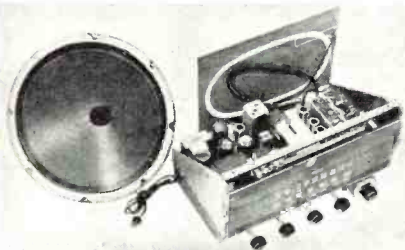

Rated an excellent instrument by America's foremost electronic engineers. Fully licensed under RCA and Hazeltine patents. The photo shows the Espey Model 511, supplied ready to play. Equipped with tubes, antenna, speaker and all necessary hardware for mounting.

ATTENTION SERVICEMEN—Did you know there are over 19 million consoles waiting to have a modern AM/FM chassis installed? Here is a gigantic sales market just waiting for you to develop. In fact there are thousands of out-moded radios in your "backyard" just waiting to be replaced.

Makers of fine radios since 1928.

Write for literature RN for complete specifications on Model 511 and others.

ESPEY
TEL. TRafalgar 9-7000
MANUFACTURING COMPANY, INC.
528 EAST 72nd STREET, NEW YORK 21, N. Y.

Magic tools



for that "professional touch"

WALSCO

TV & radio alignment tools

WALSCO quality-built alignment tools give the technician the most complete line of precision instruments for every receiver.

Ask your parts jobber for WALSCO tools.

Fully guaranteed.

1. Combination hex stud and small screwdriver for I.F. alignment on Zenith, Hoffman, Belmont, and similar T.V. sets. Molded of toughest, pure nylon. Catalog No. 2526.
2. Tough, extra long (12") front-end aligner for Admiral, Emerson, RCA, etc. Replaceable nylon tip. Catalog No. 2523.
3. Duplex I.F. aligner with recessed blades. One side for #6, other side for #4 studs. Unbreakable plastic. Catalog No. 2519.
4. Short (2") I.F. tool with recessed blade. Perfect for cramped quarters.

WRITE FOR WALSCO CATALOG 51-N

WALSCO

Walter L. Schott Co., Beverly Hills, Calif. • Chicago 6, Ill.

INDISPENSABLE!

PHOTOFACT BOOKS



Photofact Television Course. Covers TV principles, operation and practice. 216 pages; profusely illustrated; 8½ x 11". Order TV-1 Only \$3.00

Television Antennas. New 2nd edition. Describes all TV antenna types; tells how to select, install, solve troubles. Saves time; helps you earn more. 200 pages; illustrated. Order TAG-1 Only \$2.00

Television Tube Location Guide. Accurate diagrams show position and function of all tubes in hundreds of TV sets; helps you diagnose trouble without removing chassis. 200 pages; pocket-size. Order TGL-1 Only \$1.50

1949-1950 Record Changer Manual. Vol. 3. Covers 44 models made in 1949, including multi-speed changers and wire and tape recorders. Original data based on actual analysis of equipment. 286 pages; 8½ x 11", paper-bound. Order CM-3 Only \$3.00

1948-1949 Changer Manual. Vol. 2. Covers 45 models made in 1948-49. Deluxe bound. Order CM-2. Only \$6.75

1947-1948 Changer Manual. Vol. 1. Covers 40 post-war models up to 1948. Order CM-1 Only \$4.95

Recording & Reproduction of Sound. A complete authoritative treatment of all phases of recording and amplification. 6 x 9". Order RR-1 Only \$5.00



Post-War Audio Amplifiers. Vol. 2. A complete analysis of 104 well-known audio amplifiers and 12 well-known tuners made in 1949-50. 368 pages, 8½ x 11". Order AA-2 Only \$3.95

Post-War Audio Amplifiers. Vol. 1. Covers 102 amplifiers and FM tuners made through 1948. 352 pages. Order AA-1 Only \$3.95

Auto Radio Manual. Complete service data on more than 100 post-war auto radio models. Covers over 24 mfgs. 350 pages, 8½ x 11". Order AR-1 Only \$4.95

Communications Receiver Manual. Complete analysis of 50 popular communications models. 246 pages, 8½ x 11". Order CR-1 Only \$3.00

Radio Receiver Tube Placement Guide. Accurate diagrams show where to replace each tube in 5500 radio models, covering 1938-1947 receivers. 192 pages, pocket-size. Order TP-1 Only \$1.25

Dial Cord Stringing Guide. Vol. 2. Covers receivers made from 1947 through 1949. Shows you the one right way to string a dial cord in thousands of models. Pocket-size. Order DC-2 Only \$1.00

Dial Cord Guide. Vol. 1. Covers sets produced 1938 through 1946. Order DC-1 Only \$1.00

HOWARD W. SAMS & CO., INC.

Order from your Parts Jobber Today, or write direct to HOWARD W. SAMS & CO., INC., 2201 E. 46th St., Indianapolis 5, Ind.

My (check) (money order) for \$..... enclosed. Send the following books:

- | | | | | |
|--------------------------------|-------------------------------|-------------------------------|-------------------------------|-------------------------------|
| <input type="checkbox"/> TV-1 | <input type="checkbox"/> CM-3 | <input type="checkbox"/> RR-1 | <input type="checkbox"/> AR-1 | <input type="checkbox"/> DC-2 |
| <input type="checkbox"/> TAG-1 | <input type="checkbox"/> CM-2 | <input type="checkbox"/> AA-2 | <input type="checkbox"/> CR-1 | <input type="checkbox"/> DC-1 |
| <input type="checkbox"/> TGL-1 | <input type="checkbox"/> CM-1 | <input type="checkbox"/> AA-1 | <input type="checkbox"/> TP-1 | |

Name.....

Address.....

City.....Zone.....State.....

NEW EQUIPMENT FOR THE AUDIO ENTHUSIAST

TAPE RECORDER

A new and portable "Re-Cord-O-phone" tape recorder, the Model RT-65, has been announced by *Bell Sound Systems, Inc.* of 555 Marion Road, Columbus 7, Ohio.

Particularly adapted for home, professional, and business users because



of its compactness and light weight, the new unit measures only 8½" high, 15" wide, and 16" deep. It weighs 33 pounds.

The unit records for immediate playback and is simple to operate. Through direct connection to radio, phono, or microphone, this equipment records any type of sound on plastic or paper tape, using 5" or 7" reels. Half of the double-track tape can be recorded or erased at a time. The 5" reel provides 30 minutes of recording time while the 7" reel provides an hour's coverage. The tape is reusable. The unit automatically erases as it records, eliminating the possibility of double recordings. An interlock switch prevents accidental erasure when the tape is being rewound.

The Model RT-65 comes complete with a crystal microphone, a 6 foot cable, an empty 5" reel, one 5" reel of plastic tape, and an instruction manual. Those desiring full details on this recorder should address their inquiries to H. H. Seay, sales manager, in care of the company in Columbus.

ELECTRIC PHONODRIVES

A new line of electric phonodrives has been introduced to the trade by *Russell Electric Co.*, motor division of *Raytheon Manufacturing Co.*, 4501 So. Western Blvd., Chicago 9, Ill.

Featuring the company's "Cat's-Paw" tangent-contact drive, the new line consists of three models comprising a three speed unit (Model DTP) which operates at 78, 45, or 33½ r.p.m., and two units, the Model DSP (deluxe) and the Model FSP (economy) at 78 r.p.m.

The model DTP has a rim-drive, 2-pole dynamically balanced motor and features a positive turret drive mech-

anism with a shift lever control throwing the drive wheel into instant positive contact with the motor shaft for the desired speed. The model is provided with either a 7¼" or 9" diameter turntable. An adapter disc for 45 r.p.m. records and a speed indicator plate is also included.

A copy of Bulletin No. 5000, covering these new phonodrives, will be mailed on request.

POLYPHASE REPRODUCER

Audax Company of 500 Fifth Avenue, New York 18, New York, is currently marketing a new polyphase reproducer, the "Audax L-6".

This single magnetic unit will play any and all lateral recordings at speeds of 33½, 45, or 78 r.p.m. A special connector is available which permits the unit to be plugged into the *Webster* changer arm and once the unit has been plugged in it becomes a permanent part of the arm, thus eliminating repeated adjustments on the arm.

The point pressure is 8 grams for all discs. The output is approximate-



ly 20 mv. Response is from 20 to over 10,000 c.p.s. The sapphire or diamond stylus is easily replaceable.

Full details on the L-6 are available from the company.

L-PAD

A new L-Pad for special application work where dependability and cost are important factors has been introduced by *Clarostat Mfg. Co., Inc.* of Dover, New Hampshire.

Known as the Type No. CM8727, the 8 ohm pad is a single unit with two separate wire windings for maintaining constant impedance. The unit was designed primarily for outdoor drive-in theaters and other p.a. uses.

The unit measures 1½" in diameter and ¼" deep. It is available on special order with impedance ranges from 6 to 300 ohms. Rotation of the control is 120 degrees.

VARIABLE SPEED TURNTABLE

Rek-O-Kut Company, Inc. of 38-01 Queens Blvd., Long Island City, New York, has announced the production of a continuously variable speed turntable featuring the company's exclu-

sive "Vari-Con" self-seating rim drive. The new turntable plays without wow at any speed from 20 to 100 r.p.m. at 50 or 60 cycles a.c. according to the



company. The company suggests that the new unit may be used by disc jockeys, TV-AM-FM broadcasting stations, advertising agencies, schools, dance studios, record collectors, and musicians.

The speeds are regulated by a simple lever movement. The unit has a 12" cast aluminum turntable with hardened and ground shaft and a constant speed, 4-pole motor with cone pulley.

SMALL INTERCOM

An inexpensive yet complete two-station intercom system is currently being offered by Mark Simpson Mfg. Co., Inc., 32-28 49th Street, Long Island City, New York, as the "Masco Midgetalk."

Consisting of one master station with "on-off" switch, volume control, and "on-off" pilot light; 50 feet of 3-wire cable; and one remote station, the new intercom can be installed rapidly and easily. The remote station can be wired for either private or non-private operation. Both stations have a press-to-talk switch and when the remote station is wired for privacy, the switch is used to originate a call to the master.

The standard model comes in a mahogany finish but decorator colors



are available at slightly higher prices. A catalogue sheet covering the new intercoms is available on request.

TWO-WAY SPEAKER

Holl Audio Industries of 9215 Venice Blvd., Los Angeles 34, California, has added the new 802-A two-way loudspeaker to its line.

Air column loading is used in this new speaker. When placed in the corner of a room, the cabinet acts as the neck of a horn while the room walls and floor form the mouth.

The 15" woofer with a 2 pound Alnico V magnet and a 2" voice coil is

PEAK ELECTRONICS CO.

COMPONENTS

SELECTED AND GUARANTEED SURPLUS AT A FRACTION OF ORIGINAL COST.
188 WASHINGTON ST., NEW YORK 7, N.Y.

PANEL METERS

GE—General Electric
WH—Westinghouse
W—Weston S—Simpson
SU—Sun Special Sale
SQ—Square Case

2" Meters		3" Meters	
0-200 UA, S*	\$ 4.50	0-20 UA, W*	\$12.50
0-500 UA, S, WH*	2.95	40-0-40 UA, W*	7.95
0-5 MA, S, SQ*	2.45	50-0-50 UA, GE	8.95
0-5 MA, GE*	1.95	0-75 UA, GE	9.95
0-20 MA, S*	1.75	0-1 MA, S*	4.50
0-25 MA, SU*	2.75	0-1 MA, WH*, SQ	4.50
0-50 MA, SU*, SQ	1.95	0-2 MA, WH, S	3.95
0-50 MA, GE	2.45	0-5 MA, GE, SQ	3.95
0-1 AMP RF, GE	2.45	0-10 MA, WH*	2.95
0-2 AMP RF, S, SQ	1.95	0-15 MA, WH, SQ	3.95
0-4 AMP RF, GE	1.95	0-20 MA, S, WH	3.95
0-9 AMP RF, WH	2.95	0-20 MA, GE, SQ	3.95
0-100 MA AC, GE	2.95	0-30 MA, GE, SQ	3.95
0-20 VOLT DC, SU	1.75	0-50 MA, GE, SQ	3.95
0-20 VOLT DC, W	2.45	0-80 MA, WE	2.95
0-30 VOLT DC, GE	2.45	0-100 MA, GE, SQ	3.95
0-30 AMP DC, GE	1.95	0-150 MA, GE, SQ	3.95

LINK TEST SET

Type #1410. Contains two 3 1/2" meters—a 75-0-75 microamp Galvanometer and a 0-1 MA multi-scale meter. Has tap switch for changing range. Ranges are as follows: 75-0-75 microamps, 1 MA, 2.5 MA, 50 MA, 25 volts, 500 volts. Ideal for balancing discriminators and general lab use. Housed in hard wood case with hinged cover. 10"x8"x4 1/2". Only.....\$14.95 ea.

PANEL METER KIT

Here's what you get:

- 2" Bakelite cased meter,
- Govt. Surplus
- Scales for all the following ranges: 0-50 ma, 0-100 ma, 0-200 ma, 0-500 ma.
- Pre-calibrated shunt. Sizes for all ranges.
- Complete instructions.

Only \$2.50 ea.....3 for \$6.75

SCR 522 TRANSMITTER/RECEIVER

Complete with tubes separate Dynamotor Power Supply. Excellent condition.....\$36.50

RAYTHEON SWINGING CHOKE

2 to 12 Henrys, 1 Amp to 100 Ma, 15 Ohms DC fully cased. High voltage insulation, ceramic insulators. Very conservatively rated. Weight 60 Lbs. \$14.95 ea.

HIGH WATTAGE ANTENNA RELAY

110/220 volt 60 cycle Solenoid. D.P.D.T. Heavy duty paralleled contacts rated at 5000 Volts @ 15 Amps Sturdy Construction. Insulating insulation. Base 8"x8"x10 1/2".
Made by Monitor Controller.....\$18.50
Same specs. as above but DPST.....12.50
Same specs. as above but SPDT.....12.50

GUARDIAN LATCHING RELAY

SPDT, 110 V 60 cy Coil, 15 Amp Contacts.....\$1.95

SENSITIVE RELAY

2000 ohm coil, SPDT, breaks at 3 MA, plugs into 6 prong socket.....\$9.95 ea.

WESTINGHOUSE SELENIUM RECTIFIER

Hermetically sealed. Oil Immersed Full Wave Bridge. 32 Volts AC Input. 24 Volts at 2 Amps Output. 2 1/2"x2 1/2"x3 1/2" hi.....\$3.75

MISCELLANEOUS BARGAINS

.02 400 volt dc.....15 for \$0.99
2 mfd 250 volts ac Oil Cond.....6 for .99
0.1 600 volt dc digital micas.....10 for .99
Buttery 2 to 11 mfd ball burn.....3 for .99
Var. cond. 150 mmf .007 spacing.....2 for .99
Variable ceramicon 20 to 125 mmf.....5 for .99
.35 mfd at 16 kv plus .75 mfd at 8kv Oil Cond.....3.95
1 mfd 7500 vdc Oil Cond......89
495 mfd 7500 vdc Oil Cond.....2.75
7 mfd 330 VAC Oil Cond......69
25 ohm 675 watt Rheostat.....2.95
50 meg 35 watt Resistor......99
10 meg 10 watt Resistor......49
2 meg 5 watt Resistor......29
250 mmf Midget Var. Ceramic......69
15 mmf Midget Var. Ceramic Ins......39
15 mmf 1% Carbon Resistor......29
4PST Lever Switch......89
Ceramic RF Switch SP 11 Pos......89

WIRE WOUND RESISTORS

5 watt ohms: 25-50-200-470-2500.....\$.09 ea.
10 watt ohms: 25-40-80-100-470-1325-2K-4K......15 ea.
20 watt ohms: 50-70-100-300-750-1K-1.5K......20 ea.
2.5K-2.7K-5K-10K-16K-20K......20 ea.

PIGTAIL MICAS

MMF: 5, 20, 50, 60, 100, 250, 300, 400, 500, 750, 800, 1000, 2000, 3000.....\$0.08 ea.

POWER TRANSFORMER BARGAIN

740 Volts CT @ 185 ma., 6.3 Volts @ 5 Amps, 5 Volts @ 3 Amps, 110 Volt 60 cy. Primary. Half Shell Mounting.....Only \$3.49

POWER SUPPLY KIT

550 volts CT, 125 ma. 5 V., @ 2 A, 6.3 V @ 4A, Pri. 117 V 60 cy. Fully Cased.....\$1.95 ea.

POWER SUPPLY KIT

Uses transformer described & illustrated plus (1) 150 ma. choke (1) dual oil capacitor, (1) socket. All for only.....\$2.99

SOLA CONSTANT VOLTAGE TRANSFORMER

2 KVA, 17.4 Amps, Input 95-135 Volts, 60 cy., 1 Phase. Output 115 Volts. Type 4, 3 1/2" L., 9 1/2" H., 7 7/8" W. \$137.00 ea.

OIL CONDENSERS

56 mfd 220 vdc...	\$3.95	10 mfd 2000 vdc...	\$4.95
4 mfd 600 vdc...	.59	2 mfd 4000 vdc...	4.90
6 mfd 600 vdc...	.79	4 mfd 4000 vdc...	6.95
8 1/8 mfd 600 vdc...	1.39	1 mfd 5000 vdc...	4.50
10 mfd 600 vdc...	1.19	1/1 mfd 7000 vdc...	2.25
6 mfd 1500 vdc...	2.95	2 mfd 6000 vdc...	9.95
10 mfd 1500 vdc...	3.75	2 mfd 7500 vdc...	12.75
2 mfd 2000 vdc...	2.25	.65 mfd 12,500 vdc...	12.95
8 mfd 2000 vdc...	3.95	1 mfd 1 mfd 15 kvdc...	17.50

HIGH CURRENT MICAS

Type G4 Ceramic Case 5/8" High, 5/8" Diameter Tolerance 5% or Better.

CAP MFD	Amps DC	KV	Price Each	CAP MFD	Amps DC	KV	Price Each
.08	60	4	\$27.50	.009	40	15	\$29.50
.1	70	4	29.50	.01	43	15	29.50
.65	60	5	24.50	.0047	23	15	24.50
.037	45	6	26.50	.0031	26	20	29.50
.02	40	9	29.50	.004	30	22	33.50
.02	55	10	29.50	.0033	25	25	35.50
.01176	40	14	24.50	.001	12	30	26.50
.0075	39	15	24.50	.0005	9	30	26.50
TYPE G1				TYPE G2			
.00024	4	6	3.95	.01	25	7	6.95

BAKELITE CASED MICAS

MFD	VDC	Price	MFD	VDC	Price
.001	600	\$.18	.025	2500	\$1.25
.002	600	.24	.002	3 KV	.90
.01	600	.26	.002	3 KV	.95
.02	600	.26	.005	3 KV	.90
.027	600	.26	.006	3 KV	1.50
.01	1 KV	.45	.002	3 KV	1.50
.02	1200	.35	.0001	5 KV	.70
.024	1500	.65	.0005	5 KV	.85
.033	1500	.75	.0015	5 KV	1.60
.02	2 KV	.90	.003	5 KV	1.90
.005	2500	.55	.005	5 KV	2.50

CHOKE BARGAINS

O-Open Frame	C-Cased
6 Hy, 50 MA, O \$0.39	4 Hy, 450 MA, C \$3.95
6 Hy, 80 MA, O .69	5 Hy, 170 MA, C 1.35
8 Hy, 175 MA, C 1.49	20 Hy, 36 MA, C .69
6 Hy, 400 MA, C 3.69	12 Hy, 250 MA, C 2.25

POWER TRANSFORMERS

Hermetically sealed. Pri. 110 Volts 60 cy.
1110 volts CT 60 MA, 920 volt CT 160 MA, 6.3V, 18A, 6.3V, 1.25V, 5V2A, 5V2A.....4.95 ea.
300 volts CT 300 MA, 2.5V7A, 2.5V7A, 0.3V, 1.5A.....2.75
1050 volts @ 20 ma, 20V, 4A, 2.5V, 5A.....2.75
940 Volts CT 425 MA, 65V BIAS.....7.95
880 Volts CT 100 MA, 6.3V4A, 5V2A.....4.99
4400 V @ 4.5 MA, 5V 3A, 15 KV INS.....4.95

FILAMENT TRANSFORMERS

110 V 60 CY Primaries—Full Castings
6.3V 12 AMPs.....\$1.95 | 2.5V 20A, 2.5V 20A \$6.95
2.5V 10A, HV INS. 3.95 | 5V 4A, 6.3V 3A.....2.50

CERAMICONS

MMF: 1.5, 2, 3, 8, 10, 20, 22, 120, 500......05 ea

SILVER MICA CAPACITORS

MMF: 10, 47, 50, 60, 340, 750, 780, 1000......09 ea.

MOTOR & GEAR BOX

Type RL42B, Motor 2 1/2 Volts DC, 1/8 HP—1 min. with Gear Reduction Box.....\$2.25 each

30 WATT WIRE WOUND RESISTORS

Ohms: 100-2500-3k-4500-5300-18k.....8 for .99

ADJUSTABLE SLIDER RESISTORS

20 Watt: 1, 5, 50 Ohms......25
50 Watt: 100, 500 Ohms......35
75 Watt: 100, 150, 200 Ohms......39
100 Watt: 20, 50, 75, 120, 500 Ohms......49

PRECISION 1% W. W. RESISTORS

Ohms: 2K, 5K, 8500, 50K, 95K......25 ea.

100 WATT NON-INDUCTIVE RESISTORS

Ohms: 250, 500, 12,500.....\$0.75

WESTON PORTABLE A.C. VOLTMETER

FREQUENCY RANGE 25 to 2400 CYCLES 0-150 Volts, Weston 433, Accuracy within 3/4 of 1% on A.C. from 25 to 1000 Cycles and within 1 1/4% up to 2400 Cycles. Mirror scale. Resistance approximately 2800 Ohms. Scale length 4.04", in case 3" x 6" x 3 1/2". Similar to illustration. Your Cost Only.....\$29.95

METER MULTIPLIERS

2 Meg 1/5 of 1% Case Enclosed 2 KV.....\$3.95
2 Meg 1/2 of 1% Tubular 2 KV.....1.95
4 Meg 1/2 of 1% Tubular 4 KV.....3.75

H V

TUBULARS

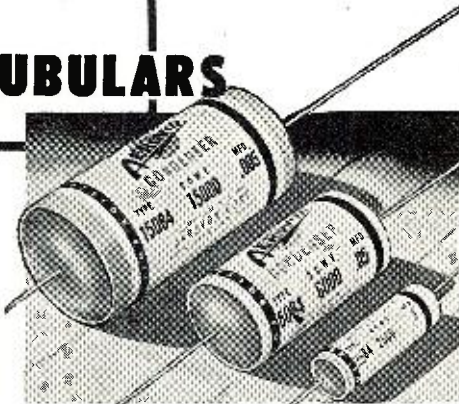

● The ever-popular Aerovox Type 84 paper tubulars are now available in 85°C extended-voltage ratings — 2500, 3500, 5000, 7500, 10,000 and 15,000 V.D.C.W. From .0001 to .15 mfd. Measuring 3/8" dia. by 1 1/2" long for smallest, to 1 1/2" by 3" long for largest.

Oil impregnated. Wax filled. Sturdy insulating tube. Sealed ends. Bare pigtail leads that

won't pull out. And dependable!

See Your Jobber . . .

Insist on Aerovox HI-V tubulars for initial equipment or replacements in TV sets, oscillographs, transmitters, etc. Ask your local jobber for the new Aerovox Catalog.

CAPACITORS • VIBRATORS • TEST INSTRUMENTS



For Radio-Electronic and Industrial Applications

AERVOX CORPORATION, NEW BEDFORD, MASS., U. S. A. • Sales Offices in All Principal Cities

Export: 41 E. 42nd St., New York 17, N. Y. • Cable: AEROCAP, N. Y. • In Canada: AERVOX CANADA LTD., Hamilton, Ont.

REK-O-KUT presents a New

Continuously Variable-Speed Turntable of Broadcast Quality



Plays At Any Speed From 25 to 100 R.P.M. Without "Wow!" Operates on 50 or 60 Cycles!

Now for the first time . . . a continuously variable turntable at a popular price. Ideal for record collectors, musicians, singers, disc jockeys, broadcast stations, music schools, dance studios, skating rinks, gymnasiums, etc. Model CVS-12P, mounted in portable case with 16" dual stylus pick-up (plays through radio or TV set) \$124.95 net. (Model CVS-12, Chassis, Motor, Turntable, \$84.95 net.)

REK-O-KUT Model LP-743 3-Speed 12" Transcription Turntable

Recommended by outstanding music critics. Induction-type motor designed for smooth, quiet, vibration-free operation. 3 speeds, 78, 45 and 33 1/3. \$49.95 net.

Write for Illustrated Catalog of REK-O-KUT Line of Hi-Fidelity Recording Instruments, Phonographs, Transcription Tables, Accessories.

See REK-O-KUT Instruments at The AUDIO FAIR, Hotel New Yorker, October 26, 27, 28, ROOM 636.

REK-O-KUT CO., INC.
38-05 QUEENS BLVD., LONG ISLAND 1, N. Y.

SHOOTS TROUBLE FASTER!

MAKES MORE MONEY FOR YOU ON JOB OR AT SERVICE BENCH!



PRICE \$9.95 at distributor or postpaid, direct. No C.O.D.'s. Please. Ohioans add 3% State Sales Tax

Signalette

MULTI-FREQUENCY GENERATOR

In radio service work, time means money. Locate trouble faster, handle a much greater volume of work with the SIGNALLETTE. As a trouble shooting tool, SIGNALLETTE has no equal. Merely plug in any 110 V. AC-DC line, start at speaker end of circuit and trace back, stage by stage, listening in set's speaker. Generates RF, IF and AUDIO Frequencies. 2500 cycles to 20 Megacycles. Also used for Checks on Sensitivity, Gain, Peaking, Shielding, Tube testing. Wt. 13 oz. Fits pocket or tool kit. Satisfaction, or money back! See at your distributor or order direct.

Clippard Instrument Laboratory, Inc.
DEPT. A, 1125 BANK STREET
CINCINNATI 14, OHIO
QUALIFIED JOBBERS WRITE, WIRE FOR DETAILS.

placed at the top of the cabinet while the port is at the bottom. The cabinet is 50" high, 28" wide, and 16" deep. Corner reflectors at 45 degree angles are used at both the top and bottom of the cabinet to direct incoming and outgoing sound waves.

The crossover is at 800 cycles, 12 db. per octave. Power rating is 20 watts, 16 ohms. The network uses air core coils and construction meets theater standards.

A brochure covering this new speaker is available on request.

PICKERING PREAMP

The Model 230H, a new, compact, small-size preamplifier to equalize low frequencies and provide necessary gain for magnetic pickups, has been announced by Pickering & Company of Oceanside, Long Island, New York.

The new preamp is self-powered, operates with any high-quality, high-input impedance amplifier and is installed by plugging it in. The company claims that the new unit is superior

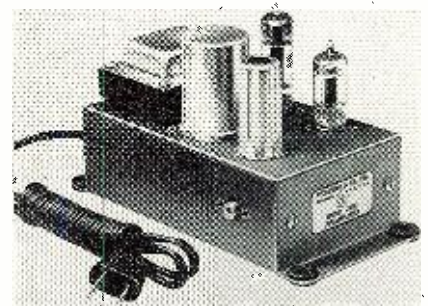

to most broadcast station equipment in its frequency response and accuracy of equalization, and that its intermodulation and harmonic distortion are exceptionally low.

BRITISH SPEAKER

A new British-made speaker, the Wharfedale W10/CSB, is now being distributed in the United States by Sun Radio & Electronics Co., 122-124 Duane Street, New York, New York.

This speaker is a 10" unit especially designed for medium-sized and small rooms. Response is said to be comparable to most 12" to 15" speakers, without the booming effect caused by the larger speakers when used in small rooms.

The center diaphragm reacts to highs, while the larger paper cone handles the lows. The cone is suspended by cloth in order to eliminate carryovers. Power input is 5 watts and the impedance is 12/15 ohms. A special cabinet has been designed to house the new speaker and full details on both the speaker and the cabinet are available from Sun Radio.

"REDI-POWER"

Designed to overcome high noise levels and solve unusual intercom problems, the Talk-A-Phone Co. of 1512 S. Pulaski Road, Chicago, Illinois, has introduced a new self-compensating control unit.

Named "Redi-Power," the new unit

RADIO & TELEVISION NEWS

provides power to reply from considerable distances. It automatically supplies exactly the right amount of power at any time for any station in an intercom system, and is especially effective in factories, schools, or large

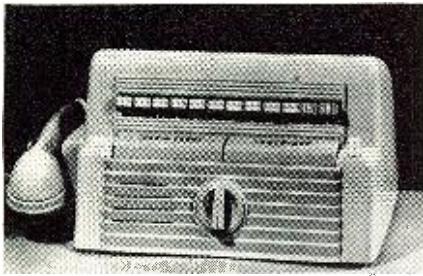

industrial establishments where there is a high noise level or where remote installations complicate intercommunication.

The new feature is built into the company's stylized bakelite cabinet which is finished in either walnut or executive gray. A brightly colored push-button alongside of the touch-bar and station control buttons makes the operation of "Redi-Power" instantaneous and convenient.

SMALL RECORD PLAYER

In order to meet the demand for a small record player, *Audio-Master Co.* of 23 West 45th Street, New York 19, New York, has recently introduced the "Audio-Master, Jr."

The new player is a three-speed portable electric phonograph which will handle 33 1/3, 45, and 78 r.p.m. records up to 12" in size. It has a high gain amplifier and a 5" permanent magnet speaker with a 1.47 ounce Alnico V magnet.

The unit also features a variable volume and tone control, and a lightweight tone arm which employs a



semi-permanent long-life needle that plays all speeds. The player is housed in a compact case which is available in various shades of colorful fabricoid.

SPECO AMPLIFIER

Special Products Company of Silver Spring, Maryland, has recently introduced the *Speco* Model 313 phono microphone amplifier as its answer to the demand for a reasonably priced, all-purpose, high-fidelity amplifier unit.

This small, lightweight, shockproof unit measures only 8 1/2" by 5 3/8" by 5" and weighs just 4 pounds. The response is substantially flat from 40 to

Real values on hard-to-obtain items

TRANSFORMERS-CHOKES:

2.5V, 10A. 10KV insulation. Suitable for 866, 836, etc. Reduced to **\$2.79** ea.

5H, 400ma chokes. Fully shielded, drawn steel case. Made by Chicago Transf. Reg. \$4.95, reduced to **\$2.95** ea.

10H, 200 ma choke. Hermetically-sealed steel case. Also has hum-bucking tap. A beautiful item only **\$1.98**.

10H, 50 ma choke. Strap mounting. Handy for dozens of applications. Reg. 98c, reduced to **65c**. Charger or fil. trans. Pri. 110V, 60 cycle. Secondary, 9-10-11-12-13 volts @ 1.2 A. Fully cased. A buy at **\$1.49**.

Vibrator transformer. 6V imp. Secondary 345-0-345 @ 150 ma. Also has bias winding. Fully cased. Bargain at **\$1.49** ea.

Power transformer. 780V, CT @ 200 ma. 2.5V at 8a. 5V at 8A. 6.3V at 6A. Pri. 115V, 60cy. AC. Has electrostatic shield. Upright mount. Shipping weight 11 lbs. Only **\$4.95**.

Fil. transf. 24V at .6 amp. Open frame type. **\$1.95** ea.

5V, 25A transf. Cased, upright mtg. A buy at **\$3.95** ea.

CAPACITORS:

4 mfd., 2500V oil-filled. Industrial Co. only **\$3.95** ea.

MICROPHONES:

Aircraft-type, push-to-talk mike. Button on top. NEW. A real buy! Were \$1.15 ea. now reduced to **59c**.

RCA Hand Mike. Hi-grade, single button. Bronze colored w/cord and plug. NEW. Were \$1.98 now reduced to **98c** ea.

TELEPHONE EQUIPMENT:

EE89 Repeaters (see previous ads). Only a few left. NEW! Regularly **\$9.95** ea. now **\$6.95** ea. RM-29A Telephones. BRAND NEW. With TS-13 handsets. Formerly **\$25.95** pr. Now **\$17.50** pr. Handset hanger. Beautiful cast aluminum shell finished in black wrinkle. Takes all makes and models. An extremely useful, well-made item only **\$1.95** ea.

EE-8 FIELD TELEPHONES

Used, workable **\$10.95** pair
Used, good **\$12.95** pair
All units tested before shipment.

STORAGE BATTERIES:

2 volt. Willard. Dry packed. Very special at **\$1.19** ea.
36 volt storage bat. Consists of 18, 2V units in sturdy case. Here is really a bargain! Only **\$17.95**.

RECEIVERS:

SCR-522 Receiver. Used, good condition. With tubes **\$14.85** ea.

R89/ARN 5A RECEIVERS. See March Radio-Electronics for converting to FM set. Brand new, orig. boxes. Now only **\$10.95** ea.

LOW FREQUENCY CRYSTALS

Precise units in holders. Ideal for oscillators as markers, BFO, etc. Can also be used as resonators for crystal filters. 453.70, 457.4, 464.81, 466.66, 468.51, 500, 450. Freq. in KC. These are an excellent buy at only **.89c** ea.

SPECIAL PLUGS & CONNECTORS

For PE-103, male and female (male fits PE-103), new **85c** set
RS-ARNS. Two special plugs **\$1.00** set
PL-Q103 for BC-348—new **75c** ea.
SCR-522 meter plug, U-13/U **25c** ea.
PL-58 fits into EE-8 telephones and many switchboards—new **30c** ea.
PL-106 fits RM-14 telephones and others—new **45c** ea.
8 pr. Female. Fits SCR-284 equip. **35c** ea.

EICO KITS in stock

Write for Circular

Power Supply for Any 274-N Receiver



Here it is—at last! Just plug it into the rear of your 274-N RECEIVER any model! Complete kit, and black metal case, with ALL parts and diagrams. Simple and easy to build in a jiffy. Delivers 24 volts plus B voltage. No wiring changes to be made. Designed especially for the 274-N receiver. All necessary parts for conversion of rest of receiver also included. ONLY **\$7.95**. TUNING KNOB for 274-N Receiver, 59c ea.

ULTRA-VIOLET LIGHT SOURCE FOR TELEVISION AND C/R TUBE EXAMINATION

O-R now presents . . . new . . . an 8-watt, ultra-violet, "black-light" source! Here is a highly effective and time saving device for checking burn spots and other defects in phosphors of C/R tubes. C/R tube face fluoresces when exposed to this special black-light to give visual indication of condition of phosphor. Reflected light from C/R tube face is negligible and tube does not have to be in operation. An invaluable device for TV service shops, schools, laboratories. Also used in medical, chemical, foods, stamps, criminology . . . a thousand uses. In kit form including Sylvania 8 watt, black-light tube, ballast, starter, mounting panel, tube clips, reflector, line cord/plug, hardware, instructions. Simple shadow box for outer housing is easily made. Complete kit (less outer housing) . . . only **\$4.95** Also . . . complete "black-light" equipment for any industrial or experimental application. Inquiries invited.

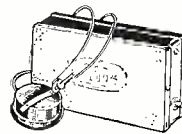

NEW! PORTABLE GEIGER COUNTER

A small light-weight unit (2 pounds), with a sensitivity that compares favorably with instruments many times its purchase price. Rugged and dependable and intended for professional use. Batteries used provide long life and low replacement cost. Each Geiger counter comes complete ready for use with instructions and radio-active ore sample for comparison tests. An extremely low price on a fine little unit—only **\$35.00**

HS-30 Phones. NEW in boxes. Only . . . **\$1.29**
HS-16 fones . . . **\$1.35** ea.

HEAVY-DUTY AUDIO AMPLIFIER

Brand-new, manufacturers over-run. 15 watts output. 2—6L6, 1—6C5, 1—6SL7, 1—5U4G. Crystal or magnetic phono input—also 600 ohm telephone line. Mounted on 10 x 17 x 9" chassis. Separate bass-treble controls. Freq. response, 40-15000 cycles. Operates from 110V, 60 cy AC. Regular **\$147.50**, reduced to **\$39.50**.

UHF WHIP ANTENNA

Four sections—extends to 24", closes to 3". Has 8/32 tapped hole in bottom for mounting. Ball on top **90c** ea.

TWELVE FOOT, HEAVY-DUTY WHIP

Actually 12'8" in length. Composed of four, sturdy sections which plug-in and screw together. Consists of sections MS-50, 51, 52, 55. BRAND NEW! A handsome buy on a highly desirable mobile antenna. Only **\$1.50** complete.

AN-75-D WHIP ANTENNA

A great buy for you mobile men. 7'3" collapsible to 14". Has 9 sections—corrosion-proof brass. Sturdy bakelite mount with jiffy wing-nut fastener. These sold formerly at **\$2.50** ea. Now, BRAND NEW, only **\$1.25** ea.



ALUMINUM CHASSIS

A beautiful little drawn, .025" aluminum chassis. 5 1/4" long, 3 1/2" wide, 1 7/8" deep. Bright-dipped finish. Use for RF stages, TV filters, amplifiers, etc. Only **49c** ea.; 3 for **\$1.35**

AN-GSC-T1 CODE TRAINING SET

Complete with 10 keys. Consists of a variable pitch audio oscillator powered by universal power supply. DC, 6-12-24-115V. AC, 115-230V. Voltage selectable by switch. Has loudspeaker and volume control. Contained in carrying case 17 x 10 1/2 x 13". Ideal for code training groups, clubs, schools, etc. NEW original boxes. Were **\$49.50**, now **\$16.95** ea.

TM-11-437 Manual. Completely describes above equipment. Circuit diagrams, parts list, etc., **\$1.00** ea.

SCOPE COMBO OFFER

The makings for an excellent scope. Includes: 1-5N1 C-R tube, transformer for hi-voltage and fil. for 2X2 rectifier, circuit diagram, only **\$7.95**

FL-8 Filters. NEW. . . . only **98c** ea.

MINIMUM ORDER \$2.00. ALL ITEMS SUBJECT TO PRIOR SALE.
ALL PRICES SUBJECT TO CHANGE WITHOUT NOTICE.

20% DEPOSIT MUST ACCOMPANY ALL ORDERS, BALANCE C.O.D.

OFFENBACH & REIMUS CO.

372 ELLIS ST.

SAN FRANCISCO, CALIF.

PHONE ORway 3-8551

LEARN IT YOURSELF

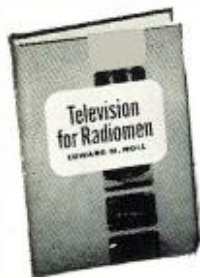

E. M. Nolle's
Complete course
of study and
working
instructions
in the book

TELEVISION FOR RADIOMEN

will help you take advantage of the good jobs open to skilled television technicians today.

● This book is not only a valuable handbook on television installation and servicing. It is also a complete course in television fundamentals. Written by a man widely known for his articles on television in the radio magazines, it explains in practical, easy-to-understand terms the construction and operating principles of every part of the television receiver and the essentials of television transmission.

● Full working instructions show each step in the installation, adjustment, alignment, and trouble-shooting of today's receivers, with especially helpful material on antennas and handy charts for locating trouble quickly and accurately.

WHAT IS YOUR PROBLEM?

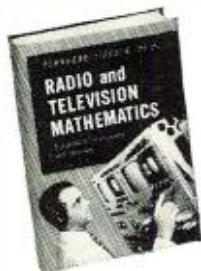

You will find the answer in the 721 problems and SOLUTIONS in

RADIO & TELEVISION MATHEMATICS

● Here are step-by-step solutions to every problem commonly arising in work on receivers, power supplies, antennas, amplifiers, tubes, transmitters, etc. If you are ever "stuck" on a calculation; if you need a check on your figuring; or if you want to refresh your memory on the formulas to use for a certain problem—you will find your answer quickly and easily in this book.

● Good practice for your FCC exams. This book shows you how to solve every problem requiring mathematics in the FCC STUDY GUIDE for licenses of all classes. You will find no better handbook for practice in solving problems with ease, speed and accuracy.

SEE THEM FREE

The Macmillan Co., 60 Fifth Ave., New York 11

Please send me a copy of the books checked below. I agree to remit in full or return the books within ten days without further obligation.

Television for Radiomen, \$7.00

Radio & Television Mathematics, \$6.00

Signed

Address

15,000 c.p.s. within ± 2 db. The power output is 3 watts and the unit uses four tubes.

As a result of using a specially designed output transformer within the feedback loop, the generator resist-



ance of the output stage is kept to a fraction of the load impedance thus allowing the connection of any speaker voice coil of from 3 to 16 ohms without loss of power.

A data sheet covering the new Model 313 is available on request.

RECORDING TAPES

Duotone Company of Keyport, New Jersey, is currently in production on a complete line of magnetic recording tapes.

The new line includes both plastic and kraft paper base tapes in extra-long 625 and 1250 foot lengths. The tapes are supplied with a low inertia plastic wheel which is said to be warp and shatterproof. The new type tapes are interchangeable with other good quality tapes making it possible to splice tapes while retaining consistently fine quality reproduction throughout the playing of recordings.

The company will supply complete details on these new tapes to those requesting this information.

AMPLIFIER UNIT

Magnecord Inc. of 225 West Ohio Street, Chicago 10, Illinois, has developed a new amplifier which is, in reality, separate recording and playback amplifiers with a common power supply.

The new unit is designed for a single microphone (low impedance input) and has 10 watts of audio output to a 4 ohm or 16 ohm voice coil plus zero level dbm. 600 ohm line output. Seven and a half and 15 inch equalizers are combined in one package and can be selected by means of a switch on the front panel. The vu. meter reads bias,



recording level, or playback level as selected by a front panel switch.

This amplifier is designed to be used with a three-headed (PT63-A or PT63-

AH) recorder mechanism when the latter is purchased originally equipped with the three heads.

NEW AMPLIFIERS

Altec Lansing Corporation, 9356 Santa Monica Boulevard, Beverly Hills, California, has announced the availability of six new amplifiers which comprise the 1400 series.

Included in the new line are the 1410A preamplifier, a 35 watt A-1402A power amplifier, a 75 watt A-1430A power amplifier, the A-1440A line amplifier, the 1450A apparatus unit, and the 30A power supply.

The new units can be used in various combinations to provide complete flexibility of application. Full details, including specifications, can be secured either from the company direct or from the *Graybar Electric Co.* outlets which are handling the distribution of the 1400 series.

NEW DYNAMIC MIKE

American Microphone Company of Pasadena, California is currently manufacturing a new full-vision, dynamic microphone which has been designated the D-33.

Designed to meet the need for an inconspicuous microphone for stage, screen, radio and television work, the new unit is finished in gold and black and has omnidirectional pickup. No



preamplifier is required with this mike. The D-33 is easily mounted for stand or suspension use and may be quickly detached for hand use. It weighs only 7 ounces and is available in all popular impedances. It comes equipped with a *Cannon* "Latch Lock" plug and 25 feet of two-conductor shielded cable.

32-WATT AMPLIFIER

The second of the company's "Green Gem" p.a. amplifier series has recently been released by *Rauland-Borg Corporation* of 3523 Addison St., Chicago 18, Illinois.

The new Model 1932 is rated at 32 watts at 5% or less harmonic distortion (measured at 100, 400, and 5000 cycles) with 48 watts peak output. The amplifier features 3 microphone inputs, 2 phono inputs with dual fader, electronic mixing and fading on all 5 inputs, and separate bass and treble

tone controls. Frequency response is plus or minus 1 db. from 40 to 20,000 c.p.s. Output impedances are 4, 8, 16, 166, 250, and 500 ohms.

The unit is housed in dark-green hammerloid case with the control



panel, finished in metallic bronze, set in a perforated aluminum-finish front section. A bulletin covering the Model 1932 amplifier is available on request.

-30-

Sound System Selection (Continued from page 81)

specifications. Record wear and mechanical operating features are also prime considerations in the selection of a good phonograph. Improper pickup arm balance and faulty record changing mechanisms can produce marked wear and tear on good recordings. At slow speeds, the failure of the phonograph to operate uniformly will result in "flutters" and "wows" which will destroy any semblance of high-fidelity reproduction. The record player must be silent and dependable. Once again, you will be wise to purchase the best phonograph available which will meet the requirements of your system at the price you can afford.

Amplifier

The selection of an amplifier for your high-fidelity system must be correlated with the selection of the FM-AM tuner and phonograph. The frequency response must be adequate to uniformly and faithfully reproduce the signal from the tuner and phonograph applied at the input. In general, the output of the tuner will be the determining factor in frequency response since it is usually of higher caliber than that which can be obtained from even the best of phonographs. In addition, the type of tuner which you purchase will determine whether or not bass and treble tone controls are necessary on the amplifier. If these controls are available on the tuner, it is usually unnecessary to duplicate them on the amplifier.

The type of phonograph pickup which you choose will determine whether or not a preamplifier for magnetic cartridges is necessary. However, as a rule, the better amplifiers include this item within the main unit. If the one which you select does not contain a preamplifier, the additional cost of such an item must be considered a part of the over-all amplifier price.

November, 1950

Lowest prices!



C-1 AUTOPILOT AMPLIFIERS

Three channel servo amplifier consisting of many valuable electronic parts including 6 relays, 7 tubes, etc. Unit removed from new aircraft.

Super Special \$4.95

C-1 AUTOPILOT VERTICAL GYROS

May be used to conduct many interesting and amusing experiments. Operates from 24 V. DC or may be operated for short periods on 110 V. AC. Gyro will run for approx. 15 minutes after actuating. Size—approx. 8"x8½"x8½". Less Amphenol Connector. Removed from aircraft. Special.....



\$4.95

PIONEER AMPLIFIERS

Shock-mounted case and chassis includes many transformers, condensers, potentiometers, etc. Supplied less output transformer and tubes.

Our Low Price 98c



DYNAMOTOR

WinCo Type 41S6. Input 13 volts DC at 13 amps. Total output 250 volts at 0.060 amps. and 300 v. at .225 amps.

Price Only \$5.95 Each

ANTENNA SPECIAL

AN-104-A. VHF Mast. Used with ARC-5. Priced at Only 89c Each

SWEEP GENERATOR CAPACITOR



Hi-speed bearings. Split stator. Silver plated coaxial type. 5-10 mmf.

Price \$2.75 each

MICROWAVE ANTENNA—

AS-217A/APG 15B. 12 Cm dipole and 13 inch Paraboloid housed in weather-proof Radome 16" diam. 24 V. DC spinner motor for conic scan. Shipping wt. 70 lbs.

Price \$9.50 each



CONTACTOR RELAY

Cutler Hammer 6041H30B. 12 v. dc. (50 amps. contacts).

Special at \$2.95 Each



PUSH-BUTTON SWITCH SPECIAL

D.P.D.T. Momentary type. Special at 59c Each

C-1 AUTOPILOT SERVO UNIT—

Use to rotate beam antenna, actuate boat rudder control, etc. Contains 24 V. motor, clutch, relays, etc. Reversible. Size overall approx. 10½"x8½"x6½". Ideal for light hoisting. Make your own garage door opener. Removed from aircraft. Large quantity.



PRICE \$8.95



BEAM INDICATOR

1-82F Compass Indicator. 0-360°-5 in. dial. 26 v 400 cy. 8-12 v. 60 cy. Ideal position indicator. Brand new.

Price \$2.95 each



SYNCHRON MOTOR

Model 600. 1 RPM. 115 Volts, 60 cycles. Brand New.

Special Price \$2.45 each

NEON BLOWN FUSE INDICATORS

110-220 volts either AC or DC. Price.....39c



SERVO AMPLIFIER

Minneapolis-Honeywell Design G-403A1. 115 v. 400 cy. Use with a-c error signal. Price \$6.50 ea. USE WITH MOTOR G303AY2. Built in gear reduction. 50 in/lb. torque.

Brand New—Special price \$6.75 ea.

RELAYS



Clare A7409-3300 ohm coil. S.P.S.T. Special at \$1.19 each.

Clare A-15764—150 ohms. 4PST. Special at 95c each.

6/12 volt relay. DC. D.P.S.T. 69c each.

6/12 volt relay. DC. 10 amps. Makes one, breaks one. Special 89c each.

SWITCHES



Mallory Wafer type. Double Wafer. 3 Position. Special 29c each.

Mallory Single wafer. Three Position. Special 29c each.

Hi-Detent—Heavy duty—4P.3T. Pos. #1, 3 on, 1 off. Pos. #2 all off. Pos. #3, 2 on, 2 off. Special low price 39c each.

Push button Switch—Enclosed—s.p.s.t. Metal housing for panel or chassis mtg. Special 19c each.

Tubes—7F7, 7N7, 7Y4, 6E6.....49c ea.

Also CIB Thyatron.....\$1.95 ea.

TERMS: 20% cash with order—balance C.O.D. Orders accompanied by payment in full must include sufficient postage, otherwise shipment will be made via Railway Express collect. Minimum order \$2.00.

Electro Devices INCORPORATED

BOX NO.1941 PATERSON, N.J.

Service-Dealers:
DO A
\$50,000
TV BUSINESS
ON A
\$500. INVESTMENT!

Get into the TELEVISION BUSINESS in a BIG WAY with the TRANSVISION FACTORY-AGENT PLAN!

- YOU GET—**
- **EXCLUSIVE TERRITORY**
 - **SPECIAL PRICES**
- to undersell competition
NO INVENTORY

You work from our MILLION-DOLLAR INVENTORY.

Requirements:

- You must be a Radio-TV Technician (experienced only).
- You must have a presentable location.

Write TODAY for complete FACTORY-AGENT PLAN, to—
TRANSVISION, INC.

Dept. RN, NEW ROCHELLE, N. Y.

FIELD STRENGTH METER

- **A must for every TV Serviceman!**
- Saves 1/2 the work.
- Improves installations.

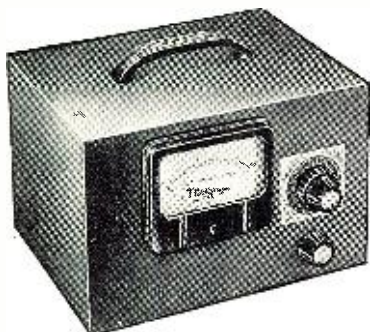

NEW LOW PRICE

Model FSM-1, complete with tubes. Net \$79.50
All Transvision Prices are fair traded; subject to change without notice. Prices 5% higher west of the Mississippi.

TRANSVISION, INC.

Dept. RN NEW ROCHELLE, N. Y.

The output requirements of the amplifier will depend upon the size of room into which the sound will be delivered and the type of speaker selected to do the job. It should be remembered that it is always better to have more power available than is necessary since most amplifiers operate to their best advantage at something less than full-rated output. The volume control always permits you to reduce the available output at will. Hum and distortion levels in your amplifier must be kept below the audible level for faithful reproduction.

For comparison purposes the following are the specifications for one of the best available amplifiers: Frequency response—20 to 20,000 cycles \pm 1 db.; hum and noise level—70 db. below normal-rated output; over-all distortion—2%.

Speaker

The problems involved in the selection of a good speaker for your high-fidelity system are dependent to a certain extent upon the individual making the selection. It is only natural that since the speaker is actually what you hear, part of the selection will be made on the basis of the degree to which the speaker pleases you as the listener. However, certain basic fundamentals must be considered. First and foremost, the speaker must be capable of handling the power output of the amplifier to which it is connected without distortion or strain. Its electrical characteristics (frequency response, distortion factor, and impedance) must match those of the amplifier if the over-all performance of the system is to be maintained.

Some engineers insist on two separate speakers—one to reproduce the high frequencies (the "tweeter") and one to reproduce the low and middle range (the "woofer"). If the two speakers are mounted on the same axis, the resultant unit is known as a coaxial speaker. Such a mounting arrangement conserves space.

The physical characteristics of your sound room play an important part in speaker selection. Size and shape can often prove to be the deciding factors.

Speaker Housing

The fifth item in your high-fidelity system, the speaker cabinet, must be considered along with the speaker itself since the two are interdependent. Proper housing of the speaker away from the other components contributes a great deal to the over-all quality of the entire system. All too often the speaker is mounted on a baffle of improper size or in a cabinet of improper dimensions. This results in distortion and poor sound distribution within the room itself. Highly desirable "wide-angle distribution" in a good speaker can be destroyed because of improper housing. With the selection of a speaker and suitable speaker housing, you have completed your choice of components for your high-fidelity system.

leading custom-builders
choose

BROWNING FM-AM TUNERS

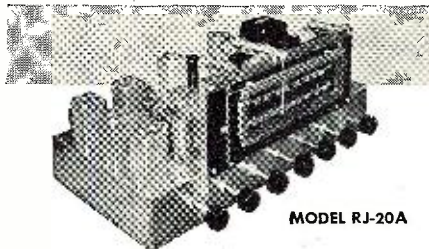

MODEL RJ-20A

To satisfy discriminating music-lovers who wish the full splendor of beautiful music — "the very best" — brought into their homes, leading audio engineers feature Browning FM-AM Tuners in their custom-built radio phono systems.

And you will recognize the excellence of Browning . . . the instant you hear it . . . music flawless and noise-free . . . every instrument sounding true . . . speech clear, with amazing realism. Tuning is precise and drift-free.

Model RJ-20A—High-fidelity FM-AM Tuner (shown above) incorporating tone controls.

Model RJ-12B—High-fidelity FM-AM Tuner.

Model RV-10A—High-fidelity FM Tuner.

All with AFC on FM



BROWNING
LABORATORIES, INC.
WINCHESTER, MASS.

Servicemen - Dealers

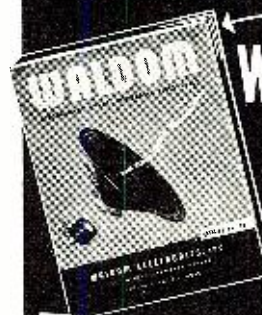

WALDOM
Replacement
Cone
Manual
Catalog No. 50

Write for your FREE copy Today!

Waldom's Free New 24-Page Replacement Cone Manual lists specific replacement data for over 75 different TV, FM, and AM Sets. This handy reference speeds-up your repair time — means more profit to You! Write today for your Free Copy. Just send your name and address to Dept. RN

For Finer Tone a Waldom Cone



Check these features:

- Hawley diaphragms — with the patented thin, tapering edge that assures maximum speaker efficiency and true low frequency response.
- The finest voice coils and spiders made with precision craftsmanship to exacting specifications.
- Unconditionally Guaranteed as to construction and performance.
- Carries the full R.M.A. Warranty.

WALDOM ELECTRONICS, INC.
911 N. Larrabee St., Chicago 10, Ill.

RADIO & TELEVISION NEWS

The BROOK All Triode High Quality AUDIO AMPLIFIERS

bring into your home

MUSIC AS IT IS PLAYED

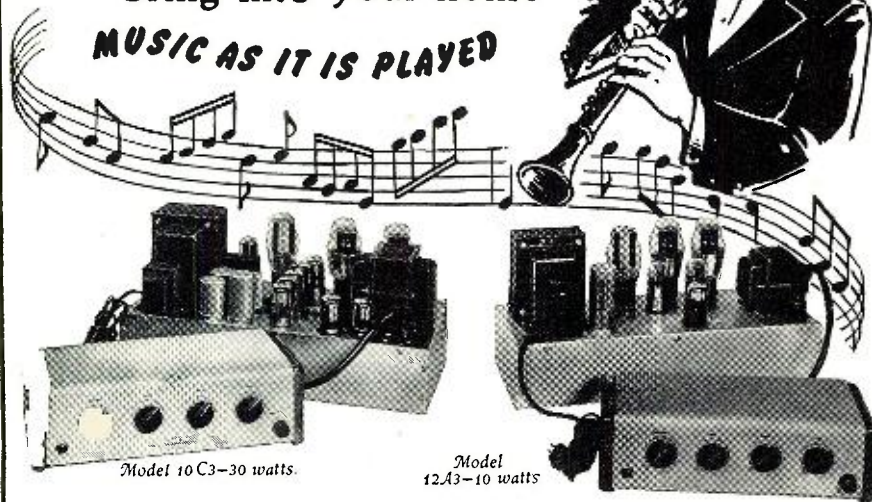

Model 10 C3-30 watts.

Model 12 A3-10 watts

Write Today for FREE Booklet,
"BETTER LISTENING",
Technical Bulletin and
detailed Distortion Analysis.

- The full volume of a symphony in your home with all its brilliance... or reduced to a whisper... still keeping its natural tone.
- Extreme low volume without loss of quality.
- Reduction of listening fatigue.
- Distortion and intermodulation at a new low.
- Separate controls stepped for bass and treble.

BROOK ELECTRONICS, Inc.
Dept. RK-O • 34 DeHart Place • Elizabeth, N. J.

tubes and keeping the three a.f. amplifier tubes fairly close together. There is apparently no harm in having the power supply components so close to everything else; there is no hum in the output, probably because leads were kept short and there are no inductors in any of the circuits that matter. Another point is that only a single connection to the chassis was made, all other ground points being connected together by *Wirex* to avoid hum loops.

No shielding whatsoever is necessary for the oscillators but all leads should be kept short. Terminal-board construction would have looked better but probably would not work as well, at least on the first try.

The gain of the v.t.v.m. amplifiers is about 45 db. and they are somewhat microphonic. That is harmless but the subassembly must be kept compact to avoid loss of high frequencies. All parts were mounted on the aluminum subchassis with very short leads before it was fastened to the panel.

This type of cabinet has a 1/2-inch lip around each of the four front and back edges. When fastening the chassis to the panel and mounting controls, therefore, spacing washers are necessary between chassis and panel so that there is room for the lip between them.

Calibration

The main tuning dial is made from a *National* ACN unit and an 8-inch recording blank. The ACN drive unit is fastened to the front panel in the usual way but the rectangular frame, calibration paper, and plastic pointer were discarded. To avoid backlash, a *Millen* 10012 right-angle drive is used to turn the main tuning potentiometer (R_{23}) which is mounted on the chassis deck to avoid long leads from the variable oscillator. There is a little looseness in the drive which can be reduced by loosening the setscrews holding the gear shafts and pushing the gears together more tightly.

The large dial spreads out the calibrations very satisfactorily. An 8-inch aluminum-base recording blank was soaked in hot water and the lacquer peeled off. Then the center hole was enlarged slightly to allow it to fit over the ACN dial shaft and three 120-degree-spaced holes were drilled for attachment to the dial mechanism. The plastic pointer that comes with the ACN was cut and drilled, then fastened to the top of the panel.

Before calibration, the instrument should be lined up and tested. If there is any trouble with the oscillators, they may be connected to an oscilloscope for observation. Both should have good waveform when their frequencies are equal, as they should be when R_{23} is at maximum resistance. Some slight trimming of oscillator component values may be necessary to get them equal to R_{23} in about the middle of its range. R_{44} should be set so that with oscillator

announcing

"GONSET LINE"

LOW LOSS OPEN WIRE LINE
(lowest loss lead-line mfd.)

- 1/2 THE LOSS OF NEW MOLDED RIBBON
- 0.5 DB LOSS PER 100 FT. AT 200 M.C.
- POLYSTYRENE SPACERS

Ideal for

- TELEVISION
- AMATEUR
- COMMERCIAL
- FRINGE AREAS
- LONG RUNS
- BEACH AREAS

"Your antenna is no better than its lead-line."

GONSET CO., BURBANK, CALIF.

PREMAX

First Again!
with
**A New Civil
Air Patrol
ANTENNA**



Designed for 2374 Kc. Is highly efficient! Has a longer range! 8 d.b. gain or 6.3 times the transmitting power. Something every C.A.P. man needs to make his mobile unit efficient. Fits any standard Pre-max Mobile Mounting.

At Your Jobber
or Write

**\$9 NET
LESS
MOUNT**

PREMAX PRODUCTS
DIVISION CHISHOLM-RYDER CO., INC.
5105 Highland Ave., Niagara Falls, N. Y.

and mixer tubes removed current through the OC's is about 30 ma.

For the frequency calibration, a paper disc about 5½ inches in diameter was fastened over the center of the 8-inch aluminum disc and the assembly was fastened in place. Starting at maximum counterclockwise rotation of R_{2s} with R_3 set for an audio frequency of about 200 cycles, a slow rotation clockwise showed that there was a slight discontinuity in frequency change about 30 degrees from maximum resistance. At the point of the discontinuity, which is the point of real maximum resistance for R_{2s} , the paper on the dial was marked zero frequency and R_3 was adjusted for zero output as indicated by the oscilloscope and a meter.

Rotation of R_{2s} toward minimum resistance was then continued, marking calibrations on the paper at each desired frequency. Another oscillator was compared with the new one at each point by using the oscilloscope's Lissajous patterns in the usual way. Operation of the 6E5 as a zero beat indicator was checked (with S_1 in the "Use" position); the shadow varies at some multiples of 60 cycles and at zero frequency but the character of the shadow action at 60 cycles is readily distinguishable.

The aluminum dial was removed and the outer edge area coated with rubber cement, which was allowed to dry and then rubbed off with the fingers. With the paper disc as a guide, black India ink, with a regular drafting compass and a *Speedball* FB6 pen, was used to draw in the calibration marks. The numbering and lettering was done with a *Wrico* lettering guide and pen. Drawing right on aluminum requires great care and some practice, for mistakes cannot be erased. It is entirely practical, however, if the aluminum is mirror-smooth and is first cleaned as indicated with rubber cement. The paper disc is removed easily afterward. When lettering was finished and checked, a transparent coating of "New-Skin" (obtainable at drug stores) was brushed on. This is nearly the same thing as colorless nail polish but is cheaper. Do not brush more than twice over one spot as the compound will dissolve India ink. Brush marks will not show. A second coat after the first one dried completed the job.

Exactly the same process was used to mark the small dials. ICA 2165 dials were purchased and the metal skirts reversed to obtain a blank surface. The small white marker lozenge on the panel above each dial was a decal obtained from a *Tekni-Cal* set. The lettered designations are the same.

To calibrate the v.t.v.m. dial, feed in a tone directly from the oscillator terminals. Set R_{32} at maximum and R_{30} for exactly zero 6E5 shadow angle. Do not touch R_{30} again during the calibration.

Place an external vacuum-tube voltmeter across the oscillator output and

SEE LEO FIRST... for HALLICRAFTERS!

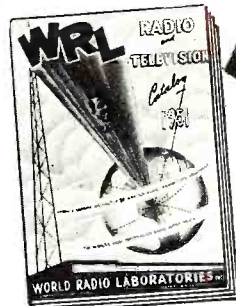

FREE WRL
1951
CATALOG

Send for the new 1951 complete WRL catalog containing everything new in radio and television. Our new catalog is bigger than ever, jam-packed with bargains, completely indexed and arranged for quick easy reference. Send for your FREE catalog today!

LEO I. MEYERSON
WØGFQ

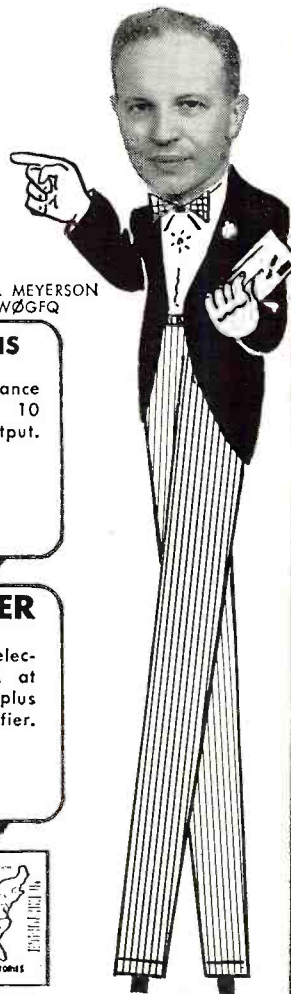

HALLICRAFTERS S-78 FM/AM CHASSIS

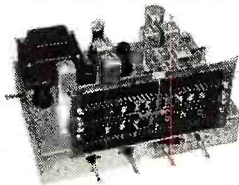

Superb broadcast performance for custom installations. 10 tubes, rectifier. 8 watt output. One RF, 21F.

Only **\$79.95**

Low Down Payment

HALLICRAFTERS SX-71 RECEIVER



Double Conversion sharp selectivity, plus built-in NBFM at moderate cost. 11 tubes plus voltage regulator and rectifier.

\$189.50

Low Down Payment

CU ON 20 - 10 & 75 METERS

GIANT RADIO REFERENCE MAP

Just right for your control room walls. Approximately 28" X 36". Contains time zones, amateur zones, monitoring stations. Mail coupon today and

25c



PHONE 7795

WRITE—WIRE



WORLD RADIO LABORATORIES
744 West Broadway
Council Bluffs, Iowa

R-11

Please send me:

- Radio Map SX-71 Info
 New Catalog S-78 Chassis Info
 List of Guaranteed Used Equipment

Name

Address

City

State

RADIO ENGINEERING I

Complete Radio Engineering course incl. Telev., U.H.F., and P.M. E.S. Degree Courses also in Civil, Elect., Mech., Chem., and Aero. Eng.; Bus. Adm. Acct. Visit campus, see well equipped labs. Low cost. Free courses. Personalized instruction. Grads successful. Founded 1884. Enter Jan., March, June, Sept. Write for Catalog.

TRI-STATE COLLEGE 1610 College Ave.
Angola, Indiana

POCKET RECORDER

Conferences
Reports, Dictation
Inventory, Sales Talks
2-Way Phone
Market Research
While Riding,
Walking, Sitting

WALKIE RECORDALL

Up to 4 hrs. of continuous uninterrupted permanent recording at a total cost of only 2½¢ per hr. Concealed candid recorder picks up at a radius of up to 60'. Permanent play-back from same unit at no cost. Fully pat'd.

Size 4"x7"x7" Weight 5½ lbs.
Dept RN

MILES REPRODUCER CO., INC
812 BROADWAY NEW YORK 3, N. Y.

HOW TO LEARN CODE FASTEST GET YOUR FCC LICENSE SOONER

New DUPLEX PRACTICE CODE Code Practice Sets generate high volume and "easy-to-copy" tone comparable to "pure d.c. note." Contains high efficiency 4-inch I'M Speaker driven by no vacuum tubes! Work 6 months on only one 1½-volt cell—No parts to burn out!

Complete with professional key and cell—Nothing else to buy! Absolutely no RI or TVL. External terminals included: 6 sets may operate on one line. Finest quality components throughout.

Model "A" (right): Wood Cabinet, red, green, yellow, or blue pastels. 3½x5x10½"—\$5.95 complete, plus 50¢ for shipping & handling. Model "B" (left): Illumertone grey metal cabinet. 3x6x6"—\$6.95 complete, plus 50¢ for shipping & handling. One-year factory guarantee on both models. Send M.O. or Check. Write for Catalog 11-N.

MARTIN MFG. CO.
Dept. 11-RN, 194 Gelston Ave., Brooklyn 9, N.Y.



IN DETROIT IT'S AARON

ALL MERCHANDISE SUBJECT TO PRIOR SALE

WIRE	
SOLID or STRANDED—Nos. 18, 20, 22	\$.50/M
PUSH-BACK—Solid or Stranded—No. 20	6.50/M
RL-5 INTERPHONE AMPLIFIER—convert to hi-fidelity phone or speech amp.—compl. with 12A6 & 12SL7 tubes—2 chokes—1 xfmr.—Dyn. for 24 Volt operation	
BC-347 INTERPHONE AMPLIFIER—contains (1) 6F8 tube and audio transformer	\$ 2.75
BC-212-G INTERPHONE AMPLIFIER—contains (2)6C5 tubes—New	1.50
BC-1141 AMPLIFIER—used with BC-625 Mine-Detector—New with following tubes: (2)1N5 (1)1G5	2.95
MINNEAPOLIS-HONEYWELL AMPLIFIER—4 tubes—115/400 cycles	6.95
FREQUENCY METER BC-906-D—Freq. range 14.5 to 23.5 MC—New in trunk with calibration chart	1.95
I-198-A SIGNAL GENERATOR—6.15 MC—New	14.95
O-30 VDC METER—2" G.E. type DW Model 531A	19.95
WESTINGHOUSE BASE METER—New with rectifier—Ohm Range—0-2000 or higher w/prop. shunts; Mill Range—0-30; Volt Range—0-150 or higher or shunts	1.95
POWER-OUTPUT METER—can be used for recorders—New in built-in carrying case	9.95
RANGE CALIBRATOR BC-436 Range Unit—110 VAC operations—contains 9 tubes in unit & 5 extra tubes—plus cables w/plugs & test prongs	29.95
clamps—New	29.95
RANGE UNIT BC-436—110 VAC operation—New	14.95
MINE-DETECTOR SCR-625—for locating metal—underground pipes, etc.—NEW, with manual in over-seas wrapping & crated	
A Few used by military collection	\$69.95
	49.95
ALTIMETER RT/APN-1—130 MC Revr.—contains 14 tubes—(3)1 meg. precision resistors—dynamotor—numerous other valuable parts—New	
T-26/APT-2 RADAR SET—80/115V 1 phase—400-2600 cycle & 26 VDC-660-day-44—contains following tubes: (2)5R4 (2)6AC4 (1)2X2 (2)60T (1)6AG-7 (1)6AR5	\$ 9.95
SCR-522 TRANSCEIVER—100-156 MC—Used but good condition—w/tubes	69.95
T-23 ARCS TRANSMITTER—1156 MC—New in cartons	35.00
BENDIX TA-12 100 WATT AIRCRAFT RADIO XMT-R—300-120 KC—807 buffer & parallel 807's in final—uses 4 12SK7 osc. tubes for each 4 channels	39.95
BC-645 TRANSCEIVER—30-500 MC—can be easily converted to citizens & ham bands—New	14.95
BC-733 LOCALIZER RECEIVER—108-110 MC—contains 10 tubes—New in cartons	6.95
RE-1 ARR-1 HOMING RCVR.—Jan. '49 RADIO NEWS tells how to convert this revr. to Hi-Freq. for use with your present revr.—contains 4 acorn tubes—12 or 24 VDC operation	5.95
274-N COMMAND EQUIPMENT	
BC-442-AM Antenna Relay—with RF meter—less 50 MNFD vacuum condenser—New	\$ 1.75
BC-453 Receiver—190 to 550 KC	9.95
BC-454 Receiver—5 to 6 MC	5.95
BC-455 Receiver—5 to 9.1 MC	6.75
BC-456 Modulator—5 to 9.1 MC	2.50
BC-457 Transmitter—5 to 5.3 MC	5.95
BC-458 Transmitter—5 to 7 MC	5.95
BC-459 Transmitter—7 to 9.1 MC—New	14.95
BC-415 Control Box for BC-456	5.95
DM-33-A Dynamotor for BC-456 Modulator	1.00
BC-450-A Control Box for Receivers	1.50
NAVY RECEIVER BC-104—1.5 to 3 MC—new in carton	16.95
RT-48-A/TPX-1 TRANSCEIVER—part of AN/TPX-4—New	\$50.00
TRAINER BEACON BC-691-TL-U.H.F.—14 tubes—RADAR INDICATOR BC-700—from Radar SCR 521 (ASB) with 7 tubes less 5" CR tube & shield—makes excellent scope—New in a 30x18x10" chest	39.95
R-29/APS-2C—contains 42 tubes including (1)5E7 (1)2AP1 CR tube—with blower-motor, etc.—New in crates	12.95
COIL ASS'Y BOX—contains variable & fixed conds.—chokes—resistors—coils—out of BC-312 revrs.—New	42.50
BC-746-A TUNING UNIT—complete with 2 tubes (4855 & 5300 KC) RF coil 4875 KC—can be converted for 1104—1.5 to 3 MC	1.75
RADIO FILTER—RT-5 or RT-9	1.00
J-38 BREAK-IN TELEGRAPH KEY—on Bakelite base—43"x5" has binding post—circuit closing switch—1 1/8" silver keying contacts—etc.	.39
WELL-KNOWN TV CHASSIS—cadmium plated steel—1634"x134"—will take 7-10-12" tube—cutouts plus numerous condensers, xfmr. & other mounting cutouts—control cutouts front—Shields in metal—crg. sub-assembly tuner chassis 7"x3 3/4"x3"—cut-outs for 3 peanut tubes & interstage xfmr.	
SAME CHASSIS, but with sub-assembly wired and CR tube yoke mount.	\$1.69
OSCILLOSCOPE BC-403-C—Made by RCA for Army—110 VAC 60 cycle—complete with all tubes	\$69.95
MN-52-B 'C', 'H' or 'J'—New w/crain of wheat light	.75
RM-29 WALL PHONES—similar to EE-8, but in metal case—less phone	7.95
TS-13 Phones for RM-29 Unit—New	4.00
BUTTERFLY CONDENSER—with silver plated loop attached—approx. 1"x1 1/2"—New	.38
98-156 MC	.49
100-300 MC	.49
RELAYS—NEW	
LEACH # 1015—24 VDC—374 ohms	\$.97
LEACH # 1016—24 VDC—375 ohms	.97
LEACH # 1024-A—24 VDC—265 ohms	.97
LEACH # 1054-ARW—24 VDC—180 ohms	.97
LEACH # 1230—24 VDC—95 ohms	.97
LEACH # 1232—24 VDC—265 ohms	.97
LEACH # 1265-NA—24 VDC—265 ohms	.97
LEACH # 5053 Soleoid—24 VDC—25 ohms	.97
DUROKOL TIME RELAY—110 VAC—1.7	1.7
12 VDC SPST—50 ohms Relay	.97
28 VDC SOLENOID—125 ohms	.97
GUARDIAN ELECTRIC #32957—24 VDC—250 ohms	.97
GUARDIAN ELECTRIC #32957—6 Volt regulator	.97
GUARDIAN ELECTRIC #32957—24 VDC—250 ohms	.97
G.E. RELAY #K 273852—24 VDC—used	.97
6 VDC RELAY—Single pole—normally open—30" amp contacts—can be used as a keying relay—made by RMC	1.25
RATCHET RELAY—coil # 55333—28 VDC with 8" shaft and water switch—New	1.00
RELAY SWITCHES—by Model Railroad—14 VDC or 28 VDC—New	.75

ALL MERCHANDISE SUBJECT TO PRIOR SALES
ALL ITEMS USE LESS OTHERS STATED
ALL ORDERS F.O.B. DETROIT, MICHIGAN CUSTOMERS ADD 3% SALES TAX. 25% PAYMENT MUST ACCOMPANY ALL ORDERS.

AARON ELECTRONIC SALES

3400 CHEM, DETROIT 7, MICHIGAN • LOrain 8-9966

note the voltage. Using a decibel table, increase the signal 1 db. at a time as shown on the external v.t.v.m., each time making a mark on the paper disc attached to the dial of R_{30} after readjusting it for exactly zero shadow angle on the 6E5. The total useful range with a standard potentiometer is about 16 db.

Divide this into plus and minus, so that calibration runs from about plus 8 to minus 8 db. (with minus in the direction of clockwise rotation). Now when using the voltmeter, the calibrated control is set at zero decibels and the "Preset" is adjusted for exact shadow closure at reference level—usually at 1000 cycles. As the output of the tested device varies with frequency the calibrated control is reset for shadow closure and the increase or decrease in signal transfer read from the dial in decibels.

-30-

Mac's Service Shop

(Continued from page 82)

"Not so well as we are going to do," Mac promised. "I have signed up for some newspaper advertising and have taken a spot announcement on the local radio station explaining that we are ready and eager to take care of any and all p.a. requirements. Our office force, Miss Perkins, has been alerted to comb the newspapers for any news of picnics, reunions, bazaars, etc., at which a public address system might be needed. When she finds a promising lead, she immediately contacts the chairman of the committee on arrangements and gives him or her a powerful sales talk on our service.

"To take care of all the business that these methods will bring in—I hope—several new pieces of p.a. equipment have been ordered. I intend to have enough of everything on hand so that one complete sound system will always be in reserve here at the shop. No servicing of our equipment will be attempted in the field. If trouble develops, we shall simply determine what portion of the system is at fault, yank that unit, and slide in a replacement. That means our customers will get the fastest possible service, and it also means that an untrained technician—even you—can take care of a complaint."

"Ignoring your snide insinuation," Barney loftily answered, "that means that every bit of our equipment from microphones to speakers will have to be completely interchangeable, doesn't it?"

"Check. All of our equipment has been purchased with that in view or adapted immediately after purchase so that every microphone, speaker, or turntable can be used with every amplifier."

"You said we are also going into the sale and installation of sound equipment on a bigger scale. Got any high-powered ideas on that?"

"Lots of 'em," Mac replied promptly.

"The other day, being very hard up for something to read, I picked up a couple of the wife's home-making magazines. Imagine how surprised I was to find extensive articles in each extolling the many advantages of having a complete custom-built sound system either included in the plans for a new home or built into an older house. One writer said that in the home of a music-lover such a system was almost as essential as a heating plant!

"While I can't quite go along with that—not in this climate, anyway—I was impressed with the fact that customers are more 'high-fidelity conscious' than I realized. Obviously, the old technician's secretly-despised tin-eared public that thought its radio sounded best when all of the highs were being chopped off by an alleged tone control has suddenly come of musical age. These people are ready and waiting to be sold really good custom jobs for their homes, and it is high time we technicians woke up to the fact. The sale and installation of such a system represents a tidy profit right on the barrel-head, and the maintenance of the equipment will provide a steady source of income over the years."

"Sounds great," Barney agreed; "but how do we snag these custom jobs?"

"Mostly by letting the customer sell himself. If he once has a good chance to compare the sound of a good amplifier working into a fine speaker with the kind of audio delivered by the ordinary radio-and-record-player combination or TV set, he is more than half-sold. But as a clincher, we can illustrate the added convenience and economy of a custom setup."

"Illustrate?"

"That's right. In the next couple of weeks we are going to build up a couple of portable hi-fidelity demonstrator rigs. Each of these rigs will contain three separate units: (1) a rugged, well-built, three-speed turntable and a control panel, (2) a high-fidelity amplifier, and (3) a fine coaxial speaker in a bass-reflex cabinet. Cables of various lengths will be provided so that the parts may each be placed most conveniently in the individual home. Provision will be made for running the customer's radio or TV set through the amplifier so that he can hear the quality he has been missing. If he likes, we can also set in a really good AM-FM tuner at the same time."

"I can see that the customer is going to be impressed with the sound-quality and convenience of a custom job like that, but I don't quite get how you are going to show him that it is economical," Barney said slowly. "Good quality in audio equipment doesn't sell for peanuts. A high-fidelity speaker alone costs more than a whole a.c.-d.c. receiver."

"That's true," Mac nodded, "but we are going to show our customers that the money they spend for a custom job really goes into quality electronic equipment instead of expensive furni-

ture. A good, well-installed custom job will out-perform many console combinations costing two or three times as much simply because its cost has all been aimed at pleasing the ear instead of being spread thin in an effort to please both the eye and the ear.

"At the cost of an extra speaker and a little wire you can have high-quality music piped into any room in the house. Moreover, no matter what kind of a receiver you may purchase in the future, your custom audio system stands ready to give you the very best in sound reproduction from that new set."

"I saw a good example of that last night," Barney offered. "A fellow down the block asked me in to see his new TV set. He has always been a high-fidelity crank and has a fine sound system installed in his home. The new TV set was actually just a tuner that was specially designed for custom installation. A low-impedance line fed into the audio amplifier; and, Man, you should have heard that quality! It was just like being there.

"The tuner itself was mounted right into a wall, and it really made a neat installation. The picture was much better than average, too, because, as you mentioned, the manufacturer had put the money he ordinarily would have had to spend on a fancy cabinet and a mediocre sound system all into getting a good picture. The sweep circuits had refinements that made the picture steady as a rock, and the owner told me that only twenty-five microvolts of signal would produce one volt at the detector. A feature that is mighty handy for this fringe area allowed the operator to choose either a broad, high-fidelity picture i.f. or a narrowed, high-gain i.f. band-pass for use when the signal was weak. In this way, when you needed it, you could have a 10 db. boost of the signal by merely flipping a switch. That combination of high-quality tuner and high-quality amplifier makes the best TV installation I have yet seen and heard in this fringe area."

Mac stood up and stretched until his muscles cracked. "Well, Red, it looks like we could sit here and talk about this sound sideline until morning; but I guess we had better break it up, or Miss Perkins will be the only one to show up in the morning. Go on home and go to bed; or, as you hams put it, start modulating the mattress!"

-50-

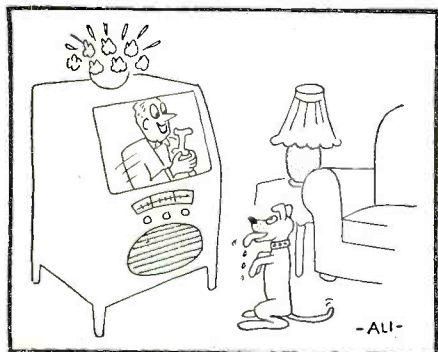

November, 1950



**The PROFIT-WISE
Serviceman Specifies . . .**

New
STANCOR PRODUCTS



**8400
POWER
SERIES**

A comprehensive line of 35 part numbers designed for replacement and new construction. Wide range of applications based on a thorough study of today's power transformer needs. Most ratings available in a choice of vertical or horizontal mountings.



**OUTDOOR LINE
TO VOICE
COIL**

Two new units designed to fit most needed outdoor applications. Primary impedances of 3,000/2,000/1,500/-1,000/500 ohms; secondary impedances of 16/8/4 ohms. Part Number A-3333 rated at 14 watts. A-3334 rated at 25 watts.

**STANCOR
TRANSFORMERS**

Using Stancor replacement transformers for your radio, TV and sound service jobs is the sure way to fatten your bank account. Here's why —

- Quality comes first with Stancor. Ability to "take it" cuts down call-backs—keeps your customers happy with a good job.
- Stancor has the largest line in the industry. A choice of 450 part numbers, in some 30 mounting and terminal styles, enables you to get exactly the right unit for almost any application.
- Easy-to-read instruction sheets and clearly marked terminals make your job quicker and easier. Saves valuable shop time.

New Stancor units are coming out all the time. Keep posted. Ask your Stancor distributor for our latest catalogs.



Most Complete Line in the Industry

STANDARD TRANSFORMER CORPORATION 3584 ELSTON AVE., CHICAGO 18, ILL.



*Get
EMERGENCY BAND
CALLS At Home!*

POLICE FM ALARM

RADIO APPARATUS CORPORATION
DEPT. RN-11, 310 FOUNTAIN SQUARE THEATRE
BLDG., INDIANAPOLIS 3, INDIANA

● Many fans spend hundreds of happy hours listening to city and state police calls on their Police-Alarm radios. . . . Police-Alarm Model PR-31 is a quality radio which will give years of trouble-free service on the 30-50 mc. band. Can be used on either AC or DC current of 115 volts.
Besides police calls, the 30-50 mc. band also is used by fire departments, ambulances, border patrol, forestry, maritime, railroads, bus lines, and other services. Enjoy the thrill of listening to these vital messages at home. Model PR-31 (illustrated) **\$44.95**
Police-Alarm Model PR-8 is available for 152-162 mc. band reception. **\$44.95**
Price, complete.

HARVEY

DELIVERS PROMPTLY...
EFFICIENTLY... AND
AT LOWEST PRICES!

THE PICKERING CARTRIDGE



Models D-120M, S-120M, D-140S and S-140S, with diamond or sapphire stylus, produce the finest quality reproduction of lateral recordings.

Models D-120M and S-120M are for standard playing records and transcriptions requiring 2.5 mil styli. Models D-140S and S-140S are for long playing, microgroove records, 33 1/3 and 45 RPM.

Model S-120M, with .0027" Sapphire stylus...\$9.90
Model D-120M, with .0025" Diamond stylus

\$24.90

Model S-140S, with .001" Sapphire stylus for long playing Microgroove records...\$15.00

Model D-140S, with .001" Diamond stylus for long playing Microgroove recordings...\$36.00

Model R-150, less stylus for home phonographs \$9.90

TECHMASTER

America's Finest

TV Chassis

Made by Techmaster Products Co. 630 circuit RCA licensed. For all size Kinescopes,

round or rectangular. Full-rated high voltage... improved AGC... advanced turret 12-channel tuner... molded tubular condensers... perfect linearity... four tube split sound circuit... full 4 Mc bandwidth... hi-fidelity FM TV sound.

1630 Chassis—Turret Tuner\$165.00

1930 Chassis—Turret Tuner\$165.00

1630 Chassis—DuMont Inputuner\$185.00

1930 Chassis—DuMont Inputuner\$185.00

Similar to Item 1 but with Push-Pull

True-Fidelity Output.....\$185.00

Similar to Item 2 but with Push-Pull

True-Fidelity Output.....\$185.00

Prices Are Less Kine

16AP4A\$40.00

19AP4A\$62.00

16" or 17" Rectangular Tube.....\$40.00

(All Tubes Black Face)

WILLIAMSON HR-15 AMPLIFIER KIT

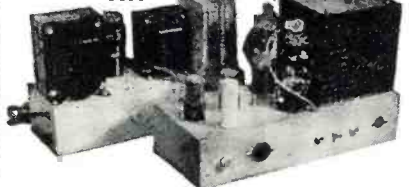

The famous Williamson HR-15 amplifier circuit... now available with the original Partridge transformers built to Williamson's specifications. Build this kit in 3 hours or less, and enjoy sound of a quality you never heard before. The HR-15 is a 2-Chassis power amplifier for use with tuners or other front ends having own volume and tone controls. All American triodes, 2-6SN76GT, 2-807, or 6BG6G in PP output, 5V4G rectifier. Response ± 5 db, 10-100,000 cycles. Output impedances 1.7 to 109 ohms in 8 steps. Absolute gain 70.8 db, 20 db. of feedback around 4 stages and the output transformers. Kit is Complete with Tubes, Punched Chassis, Pre-wired Resistor Board, Sockets, Genuine Partridge Output Transformer, and All Necessary Parts.....\$75.00

VISIT THE AUDIO-TORIUM—Come in and visit our new sound department... all these items and many more on working display at all times.

NOTE: In view of the rapidly changing market conditions, all prices shown are subject to change without notice and are Net, F.O.B., N. Y. C.

Telephone: **hr** LUXemburg 2-1500

HARVEY

RADIO COMPANY INC.

103 West 43rd St., New York 18, N. Y.

MARS

Station of the Month

MARS BEAMS WEEKLY BROADCASTS

MARS—Army Headquarters station, WAR, located at the Pentagon Building, Washington, D. C., broadcasts a weekly message each Tuesday at 0100Z and at 0400Z. (This is Monday at 8 p.m. and 11 p.m., Eastern Standard Time; Monday at 7 p.m. and 10 p.m., Central Standard Time; Monday at 6 p.m. and 9 p.m., Mountain Standard Time; and Monday at 5 p.m. and 8 p.m., Pacific Standard Time.)

Simultaneous broadcasts are made on frequencies 3497.5 kc., 6997.5 kc., 14,405 kc., and 20,994 kc. Each message is sent three times, once at 10 words per minute, once at 15 words per minute, and once at a higher rate of speed—usually 20 words per minute.

Designed especially to transmit quasi-official traffic and training information to MARS members, the broadcast offers an excellent opportunity to all amateurs in building up their code proficiency.

AF6AIR/K6AIR, MARS station for Headquarters Fourth Air Force, Hamilton Air Force Base, California, has been named MARS Station of the Month by Major Rawleigh H. Ralls, Chief MARS, U. S. Air Force. The happy resolution of an unusually touchy problem is the basis for this recognition; that is the merger of base amateur club with that of MARS activities, into a strictly first class installation.

Captain Kermit R. Parker W6JFN, MARS Director for Fourth Air Force, has done an outstanding job in every department of the program. He has procured and distributed surplus on a sound basis of the membership's ability to modify it and put it into operation on a MARS net, and this took Saturday and Sunday work. He has kept a constant flow of information to his members in the form of bulletins

and personal letters and has built his net participation up to the point of saturation on a number of frequencies.

With a high degree of tact he sold the old gang of hams at Hamilton on the idea of combining W6ZOE with K6AIR for a maximum utilization of the equipment. Now K6AIR is open seven days a week and is available at all times to MARS members and non-member amateurs at the base.

Parker's assistants are M/Sgt. Daniel G. Olivier, "Danny," W6IHC, in charge of supply and holds down a trick as operator, T/Sgt. Ralph N. Van Natta, "Van," W6WET, in charge of net organization, membership applications, and regular operator, and T/Sgt. William B. Coe, "Bill," K6FAK (4th Rescue Squadron) is chief operator and installer extraordinary at K6AIR/AF6AIR.

AF6AIR run skeds on 1752.5 A-1,

This is the group that installed and is operating Headquarters Fourth Air Force MARS Station AF6AIR at Hamilton Air Force Base, California. From left to right: Capt. Kermit R. Parker, AF6JFN, MARS Command Director, Fourth Air Force; T/Sgt. Bill Coe, AF6FAK, M/Sgt. Dan Olivier, AF6IHC, and T/Sgt. Ralph Van Natta, AF6WET.



and 1762.0 A-3 on 24 hour basis and a fast fone net daylight hours only on 7832.5 and drill nets and informal discussions A-1 and A-3 on 3222.5. It also keeps regular sked with AIR in the Pentagon. A heavy traffic load is handled to the Pacific and the Far East by MARS ops and K6AIR indulges in general amateur operation on all amateur bands from 160 through 2 meters.

The equipment list, in addition to that pictured, is a 100-watt two meter transmitter with v.h.f. 152 and *Super-Pro* for receiver combination, and a *Temco* 1000 for c.w. operation as well as another BC 610 used solely for 10-meter operation.

The antenna complement consists of a 900 foot long wire, and a pair of V-beams for U. S. and the Far East, a 4-element rotary beam for 10 meters and inverted L's for each of the MARS frequencies.

The whole gang at Hamilton works as a team and participates in all amateur as well as MARS activities. Creditable scores have been turned in in all contests.

-50-

How to Judge Audio

(Continued from page 44)

cleanly and without "fuzz" or stridency, and therefore seems somewhat lower in total tone. On the other hand, the high notes reproduced on a system with a high frequency cut-off, have a dull, lackluster timbre. On a low fidelity system the triangle has a bell-like tone all right; but it is the tone of a bell which is damped by being held in the hand while struck. In a very fine system, the bell-like tone is clear and sharp, with an added brilliance, as if the bell were hanging on a non-resonant string. On a distorting amplifier, the bell-like tone has "spikes" all over it, as if the bell had been shattered by the blow and the sound of the breaking glass or metal added to the original tone.

Nowadays, with inexpensive audio generators and even more inexpensive test records, it is easy to make a frequency run on the reproducing system. Presuming such a run shows a smooth, nearly flat or absolutely flat response to 10,000 cycles and beyond, the next thing to do is to listen with the ear, while varying the volume upward, to see if the high frequencies are reproduced cleanly and without fuzz, stridency, or outright harshness. If, in addition to such cleanness, the system can be listened to for hours at a time without fatigue, you can assume you have a good high frequency response.

Voices are good tests of undistorted high frequency response. The sibilants, such as the "S's" and "Th's" and the "ce" in the word chance, should be heard plainly and cleanly. The intensity of these sibilants varies with individual voices but in the average voice is amazingly high. If the system has a good and undistorted high frequency response, the sibilants will

MICROPHONES

- Pressure
- Velocity
- Cardioid
- Varacoustic
- Hand Sets
- Sound Power
- Telephones
- Stands, Plugs, Cables and Connectors



AMPLIFIERS



- Pre-Amplifiers
- Line Amplifiers
- Voltage Amplifiers
- Power Amplifiers
- Remote Amplifiers

SPEAKERS



- Cone Type
- Horns and Drivers
- High-Fidelity Speakers
- Speaker Accessories

SPEAKER HOUSINGS



- Baffles, All Types
- Console Cabinets

INTERCOM SYSTEMS



- All Master Systems
- Master-Remote Systems
- Combination Systems

CUSTOM-BUILT EQUIPMENT



- Consoles
- Desks
- Turrets
- Cabinets



PORTABLE SOUND SYSTEMS



PROGRAM CONTROL UNITS



- Single Channel
- Dual Channel
- Custom-Built

Why shop around?

It's easy to get the right equipment from RCA's full line of matched sound products

Buy your sound products the easy way. The wide variety of RCA Sound Products simplifies your problem of finding the right equipment for your sound jobs.

Every item in RCA's extensive sound line is electronically engineered with its own special characteristics to give top performance, dependable long-life service with quality appearance. Not only is the

RCA Sound Products line built right, it is also priced right to enable you to build a steady volume of profitable business.

No other manufacturer offers so extensive a line of "matched" sound products from the smallest "ballyhoo" system to the largest systems for industrial, educational, institutional, church, hotel, hospital or commercial users.

See your RCA Sound Products Distributor for catalog and new sound sales manual



SOUND PRODUCTS
RADIO CORPORATION of AMERICA
ENGINEERING PRODUCTS DEPARTMENT, CAMDEN, N.J.

In Canada: RCA VICTOR Company Limited, Montreal

AD-VANTAGE

Take advantage of the world's biggest Classified Ad opportunity—Your ad in

RADIO & TELEVISION NEWS Classified Section will get more action—more inquiries—quicker, and at less cost than in any other magazine. Monthly net paid circulation over 200,000.

PRINT YOUR OWN POST CARDS

COMPLETE OUTFIT
only
\$7.50

Amazing results in sales, inquiries and contacts... saves time and money... very easy to use GEM STENCIL DUPLICATOR is ideal for Advertising, Announcements, Notices, Labels, Forms, Price Lists—hundreds of uses for every type of business and organization. Comes complete with all supplies, instructions and 60-page Book of Ideas.

FREE TRIAL OFFER: Try it before you buy it! Write and a GEM OUTFIT will be sent you postpaid. After 10 days, send only \$7.50 or return the GEM, no questions asked. The GEM must sell itself; you be the judge.

BOND EQUIPMENT CO. • Dept. 111
6633 Enright • St. Louis 5, Mo.

SEND NO MONEY • FREE TRIAL OFFER

look to ALLIED for your high-fidelity custom sound components

WORLD'S LARGEST STOCKS
OF ALL FAMOUS MAKES

ON HAND FOR IMMEDIATE DELIVERY

Altec-Lansing • Audio
Development • Bell • Bogen
Brook • Browning • Collins
Clarkstan • Electro-Voice
General Electric • Jensen
Jim Lansing • Knight
Livingston • Magnecord
Market • Masco • Meissner
McIntosh • National
Pickering • Presto
RCA • Rek-O-Kut
Radio Craftsmen • Scott
Stephens • Thordarson
University • V-M Corp.
Webster-Chicago
Western Electric

IF IT'S HI-FI...
ALLIED HAS IT!

Just name your need in high-fidelity audio components—ALLIED will deliver *immediately* from the country's largest in-stock supplies. Make your selections of tuners, amplifiers, speakers, baffles, cabinets, record changers, transcription and phono equipment, wire and tape recorders, pre-amps—all the equipment you want, with the exact specifications required—at the price you want to pay. For *everything* in hi-fidelity sound, depend on ALLIED.

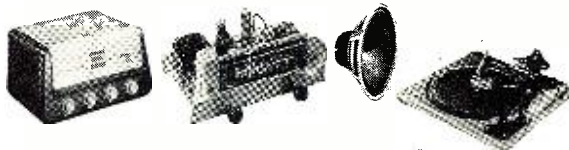

FREE 1951 CATALOG

Write today for our complete Buying Guide. (Custom Installers... ask to be put on our special mailing list.) WE STOCK EVERYTHING—FOR IMMEDIATE SHIPMENT—ANYTIME—ANYWHERE.

ALLIED RADIO

833 W. Jackson Blvd., Dept. 1-LL-0
CHICAGO 7, ILLINOIS



be reproduced plainly; loudly, and very naturally.

If the system has low distortion, the "noises" accompanying music should be audible. In the Serkin recording of Beethoven's "Emperor Concerto," for instance (Columbia M-500) during the solo trills and runs in the treble, it is possible to hear the thumps as the keys hit bottom. These thumps are low frequency noises but they are masked if there is high frequency distortion and their audibility is, therefore, a good check test, for high frequency distortion. A drummer's percussion instruments and effects are good material for listening tests. Especially good are the Latin American bands with their castanets, brushed drums, and various odd percussion instruments. Most of these produce not musical tones but rhythmical noise; the better the high frequency response the clearer and more natural such noises. The recording of "Dry Bones" by Waring's "Pennsylvanians" has many odd sound effects in the "noise" category which make excellent test material.

But perhaps the best single test of undistorted high frequency response is a piece of very modern symphonic music with clever dissonances. Aaron Copeland's "El Salon Mexico" (Victor DM-546) is a wonderful example. The word "dissonance" is not quite accurate; it is because the passages in this work are not out and out dissonances that they make such fine test material. What Copeland does in this exciting music is not to produce out and out dissonances but rather to see how close he can come to outright dissonance without actually producing it. In several passages he gets right up to the edge of the cliff, but never quite goes over into dissonance.

If the recording, which by the way is excellent and of low inherent distortion, is played on a fine system, the effect will be that intended—the music is not only not unpleasant but amusing and stimulating. A bad amplifier, on the other hand, will so change the harmonic structure that the passages do go over the cliff to become unpleasant dissonance.

Bass Response

The judging of bass response is more difficult than that of treble response. One trouble is that the ear possesses the very odd characteristic of imagining the existence of the fundamental even when it is not present, if the harmonics are strong. Even experienced and sensitive musicians are capable of being fooled by this illusion.

In general, as in the case of treble response, the fine system, at first hearing, appears to have less bass than the poor system, because it contributes less distortion and therefore has fewer harmonics of the fundamental. High frequency distortion is easily recognizable because it doesn't sound like music. But bass distortion may well sound like music to the unsophisticated ear.

MORE LIGHT MORE HEAT THAN ANY OTHER INSTANT HEAT SOLDERING TOOL



PHILLIPS VERSA- TOOL

NEVER BEFORE
THESE FEATURES

No job too heavy or too delicate for the Phillips Versa-Tool. Compact, 110-115 Volt AC, 310 Watts, the Phillips Versa-Tool was designed for perfect balance and ease of operation.

- **Rigid Copper Tips**—Four interchangeable tips that absolutely won't sag or bend under pressure.
- **Infinite Heat**—Heat continues to build up as long as trigger is depressed.
- **High Intensity Light**—A concentrated light beam focused where it eliminates all shadows.
- **Two-Position Switch**—Position 1 gives operator light only. Position 2 gives both light and heat.

FOR COMPLETE DETAILS WRITE TODAY

Phillips Mfg Co.

2816 Aldrich Ave. S., Minneapolis, Minn.

GARRARD

"Triumph"

THE WORLD'S FINEST

RECORD CHANGER

<p>PUSHER TYPE PLATFORM</p> <p>It always works</p>	<p>JEWEL MOUNTED TONE ARM</p> <p>Disturbing resonance eliminated</p>
<p>AUTOMATIC STOP</p> <p>At end of any type record</p>	<p>HEAVY DUTY SILENT MOTOR</p> <p>Absolutely no humble</p>
<p>MUTING SWITCH</p> <p>Silence between records</p>	<p>TWO INTER-CHANGEABLE SPINDLES</p> <p>Plays records as intended</p>
<p>HEAVY DRIVE SHAFT</p> <p>No wows no wavers</p>	<p>WEIGHTED TURNTABLE</p> <p>Gives flywheel action</p>

PLAYS ALL SPEEDS

Inexpensive to install in your present set

At your dealer or write to

GARRARD

SALES CORPORATION
164 Duane St., N.Y.C.

Assume a bass viol playing a 60 cycle note and suppose the amplifier or speaker has strong second and third harmonic distortion. This means that it will add more 120 and 180 cycle components to those the instrument produces naturally. These harmonics sound like bass tones. Moreover, the peculiar quality of the ear mentioned before, gives the illusion that there is more fundamental, too. And all in all, it may well sound like a lot of bass and good bass too, to many ears—until a comparison is made with a genuine bass, and then the greater realism of the undistorted bass shows up.

Because the fine system has a wider response and less harmonic distortion, the fundamental will form a higher proportion of the total tone. So the bass will be duller, but more vibrant. In analogy, it will sound more like the sound produced by beating a rug, than that produced by beating a drum. If the fundamental is reproduced, the bass will sound "more like you could count the cycles per second," to quote a friend who was impressed upon first hearing a double bass viol in person. Moreover, there will be more vibration—sensible and "feelable" vibration of the air and surrounding solids. If you stand in front of a speaker system which is reproducing fundamental bass tones, you will feel your lungs vibrating even at low volume levels. The floor and walls of the room will also vibrate.

The better the bass response, the more the bass in music will "move." Most of the bass in modern music, both popular and classical, is contributed by the double-bass which has a range of many octaves. Unfortunately, the fact that speaker-enclosure systems are not merely reproducers of sound but generators as well, has often resulted in the double-bass appearing to be as stationary and as nearly "Johnny-One-Note" as the bass drum.

The explanation is very simple. Take a speaker-enclosure system with a marked resonant point around 100 cycles. That enclosure is a generator of 100 cycle tones and within certain limits it doesn't matter much whether it is stimulated or triggered by a 50 or a 100 cycle signal. It will still produce 100 cycle notes, just as a drum will produce the same note whether struck with a piece of wood or metal. So the bass will have a very high content of 100 cycle notes and will seem stationary even though the bass viol may be moving through the range of 50 to 200 cycles.

But if the resonant point of the speaker-enclosure system is lowered to below 50 cycles or eliminated entirely, it becomes much less a generator and much more a reproducer. So the bass of a bass viol will move up and down the scale and the "Johnny-One-Note" quality will be reduced or disappear entirely.

To summarize then, the bass response of a great reproducing system

How to Meet and Beat Local TV Installation Problems

JUST OFF THE PRESS:



Your Guide to Better TV Installations

The New **WARD**

TV and FM Antenna Catalog
Write for FREE Copy Today

Remember—every TV installation is a location problem—it varies with every set, every street, every home or building and in fact every room. But WARD makes every type of antenna to cover and cure any condition or situation that may arise.

For that reason customer's satisfaction and service engineers' profit depend upon ability to supply a style or type of antenna to fully meet every local need. That's why it pays to standardize on WARD, with a complete line, the last word in engineering and construction, and a written guarantee that means everything it says.

THE WARD PRODUCTS CORP.

1523 EAST 45th STREET • CLEVELAND 3, OHIO

only **WARD** OFFERS
TV-FM-AUTOMOTIVE-AM-SPP
ANTENNAS

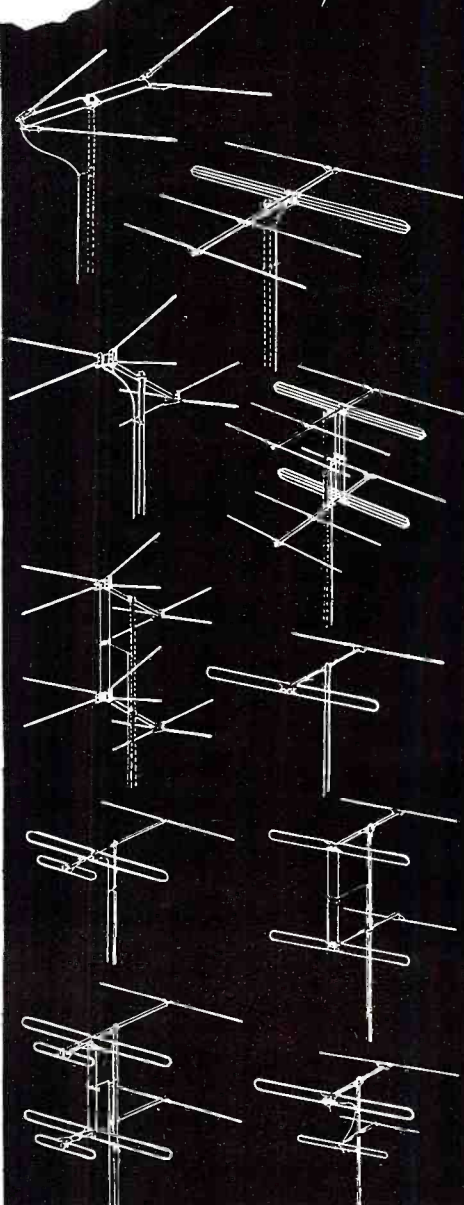

Brociner Dual-Horn Corner Reproducer

30—18,000 CYCLES

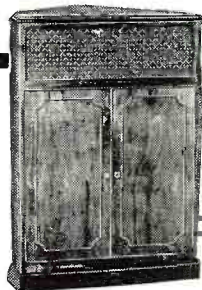

HORN LOADING for both low- and high-frequency drivers, designed to utilize the acoustic properties of a room corner provides flat, undistorted, high efficiency response down to 30 cycles.

Licensees under P. W. Klipsch patents. Exclusive distributors for New York, New Jersey, Pennsylvania, Connecticut and Maryland.

PREAMPLIFIER—EQUALIZER

Model A100



- EXACT equalization down to 30 cycles for all makes and types of records.
- 4 turnover positions—300 cycles, LP, 500 cycles (NAB), 800 cycles.
- 6 high-frequency positions—flat, 0, 4, 8, 12, 16 (NAB) and 20db down at 10,000 cycles.
- Uses new low hum non-microphonic tube.
- High gain—90 times. Gain control included.
- Sufficient gain for use with dynamic pickups like the new Fairchild cartridge.
- Available with or without integral power supply.

BROCINER ELECTRONICS LABORATORY Telephone
1546 Second Avenue • New York 28, N. Y. • REgent 7-6794
SPECIALISTS IN HIGH QUALITY RADIO-PHONOGRAPH INSTALLATIONS

NEW!

**RECTANGULAR
BLACK TUBE**

16 in. TELEKIT

**PRICES
BEGIN AT 49.95
LESS TUBES**

**JOBBER: WRITE FOR CONFIDENTIAL
PRICE INFORMATION**

**16 BR Telekit
\$79.95 Less
Tubes**
Console Cabinet shown
\$29.95



You can build this fine 16 in. rectangular black tube TV set. All you need is pliers, screw driver, and soldering iron. It's easy to assemble; no previous knowledge of TV is required. The tuning unit and hi-voltage supply are factory wired and tested for you. A big 54 page illustrated instruction book guides you through easy assembly. Satisfactory results are **GUARANTEED** by Factory Service Plan and Warranty. Write today for complete information.

**12-B Telekit
\$69.95**
**8-B Telekit
\$49.95**

Both Less Tubes



Exciting new low prices on Telekits let you have a fine 8 1/2 or 12 1/2 inch set for a price far lower than comparable commercial sets. Over 35,000 Telekits have been successfully assembled by following the big illustrated Telekit instruction book. No previous knowledge of TV is required. Satisfactory results are **GUARANTEED** under the Telekit Factory Service Plan. Write for full information.

**12 Channel Tuner
\$12.95**



Pre-built, factory aligned. Stage of R.F. amplification. Telekit 12 channel tuner equips any TV set with video I.F. of 25.75 to 26.1 Mc and sound I.F. of 21.25 to 22 Mc. Not a kit. Complete with tubes. Only 4 wires to connect.

**Telekit Booster
\$12.95**



Brings in TV signals bright and clear. Especially helpful in fringe areas. For use with any TV set. **NOT A KIT**. Completely assembled with tubes.

TELEKIT

ELECTRO-TECHNICAL INDUSTRIES
1432 N. BROAD ST. DEPT. R PHILADELPHIA 21 PA.

will (1) be apparently lower at first hearing than that of a poor system; (2) it will be duller and deeper in timbre because it will contain a higher proportion of the fundamental; (3) it will be more vibrant, or "more like you could count the cycles per second;" (4) it will produce more sensible and "feelable" vibration of the air and solids; (5) it will "move" more and have less "Johnny-One-Note" quality.

Definition

A more characteristic quality of a fine reproducing system than the bass and treble responses—although related to both—is the quality called "definition." Audio definition can best be explained by an analogy with visual definition.

Photographers are very familiar with definition. It is perhaps the most important quality of a good camera or enlarger. A camera with good definition takes sharp, clear pictures, in which the details stand out. The individual blades of grass in a lawn, the individual hairs in a coiffure, stand out clearly and distinctly. A poor camera blurs the details.

Audio definition is exactly comparable. A system with good definition reveals the distinct, separate components of the total sound picture. Therefore, it is possible for the listener to pick out the individual instruments in an orchestra, even when they are playing the same note, and even in a loud passage or a crescendo. It will separate the individual voices in a quartet or choral group; the individual handclapping in applause; it will also show the separate components of a chord on a piano or violin.

Definition is a function of several amplifier qualities but largely of transient response. If a camera is vi-

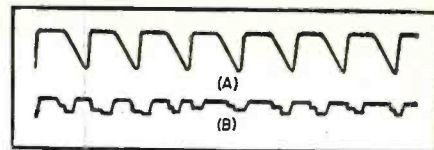

Fig. 1.

brated while an exposure is made, the resulting image will be blurred because the vibration has multiplied each line and image two or three times. Transient distortion of the type called "hangover" has a precisely comparable effect.

Take a run on the piano, played without depressing the loud pedal. From an amplitude point of view the resulting sound pattern is a series of pulses with definite intervals between each pulse, which can be represented as shown in Fig. 1A.

You will note that there are definite, discrete intervals between the separate pulses in which the amplitude is very small. But if the reproducing system is guilty of transient distortion, each note will be followed by one or more "echoes" which are generated by the reproducing system. These echoes fall in the intervals between the pulses and might be represented as shown in Fig. 1B.

It will be seen that the separation between the pulses is greatly reduced and that the pulses tend to blend into each other. This produces exactly the same type of audio blurring as vibration in a camera produces visual blurring. Such blurring greatly reduces the definition of the system.

Square-wave testing is perhaps the best objective measure of transient response and distortion, providing some means is used to include the speaker system. However, there are

Roland Kempton (right) of the General Electric Tube Divisions, explains a Tele-Clue Demonstration at the NEDA Convention in Cleveland to Arthur Stallman (center) new NEDA president, and John T. Thompson (left) manager of replacement sales for the Tube Divisions. The Tele-Clue demonstration, which was set up to show dealers how to spot TV receiver defects by means of the tube patterns, was part of the company's exhibit at the convention.

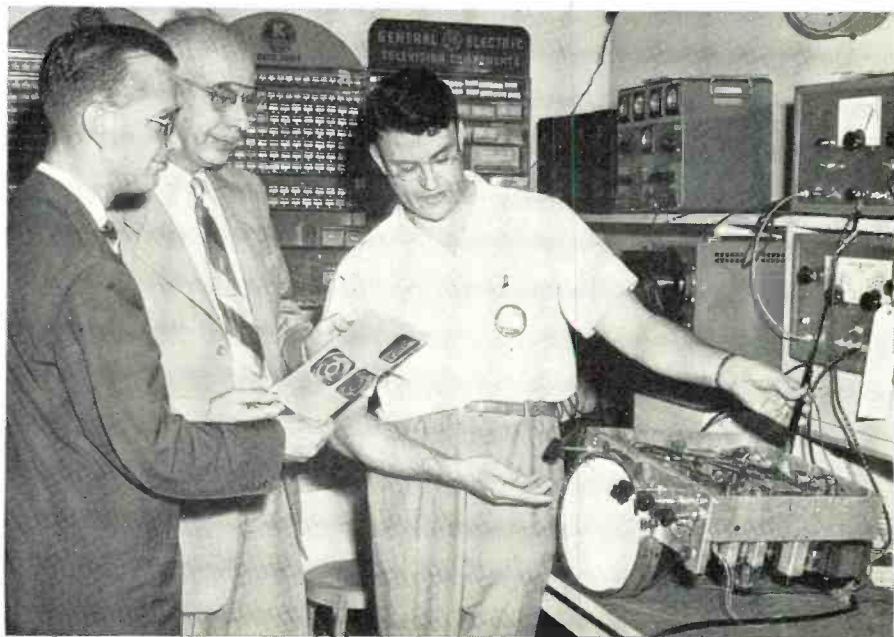

simple listening tests which give a good check for the presence of good transient response and the absence of "hangover."

The simplest is that of operating a switch whose noise is audible through the system—as, for instance, the "On-Off" switch of an associated tuner. The better the transient response the "cleaner" the tone of the noise and the shorter the time it lasts. The "cleanness" means that the thump is principally the fundamental without the addition of harmonic distortion; the short interval testifies to the lack of hangover echo.

An excellent and rigorous test is a high-speed c.w. signal tuned in *without* a beat frequency oscillator. The signal will be audible as a series of thumps. The better the transient response the more distinctly the thumps are separated. On a really high quality system, each of the thumps of a very high speed c.w. signal will be distinctly and sharply separated from the preceding and following pulses.

Piano recordings, or, better yet, an actual piano, are excellent tests of transient response. Indeed, all percussion instruments, if highly damped, are good. The kettle drums in the opening of Gershwin's "Concerto in F," for example, should be clean, sharp, and distinct. Plucked strings are very good. Look for separation of successive notes and pulses, a sharp rise and a quick decay in amplitude.

Naturalness

Naturalness is, of course, extremely important. The natural or distinctive tone of an instrument or voice is determined largely by the relation between the fundamental and the harmonics. Some of these relationships are amazing. In a typical male baritone voice, for instance, the sixth harmonic may be 10 times, or 20 db., greater in amplitude than the *fundamental*. In a violin the amplitude of the harmonics decreases rapidly with the order; but in a clarinet, the amplitude of harmonics increases and the 10th or 12th harmonic may be many times louder than the second or fourth and as loud as or louder than the fundamental.

It can readily be seen that both frequency distortion and harmonic distortion are capable of altering the harmonic structure so as to change the total character of the sound pattern and make a voice or instrument sound unnatural. Thus, if the baritone is boosted in the bass portion, the voice may be more pleasant, but it will no longer be natural, because the dominance of the harmonics has been destroyed. On the other hand, if the amplifier has great harmonic distortion, the harmonic dominance may be emphasized until it is not only unnatural but very unpleasant.

The only test for naturalness is a familiarity with the natural tone of the instrument or voice being reproduced. The simplest test is to use a good microphone and the voice of

At Last!

A YAGI WITH HIGH GAIN ON 2 CHANNELS!

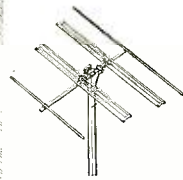

Single 4-element yagi with dual purpose elements.



Two of the new TRIO yagis may be stacked to get up to 17 DB forward gain.



The "Controlled Pattern" System eliminates "Venetian-Blind Effect" when caused by co-channel interference.

TRIO — always First in TV Antenna development announces with pride a completely new and revolutionary Yagi that *Actually* provides FULL 10 DB on EACH of Two Channels. Available for channels 4 and 5, in the low band, and channels 7 and 9 in the high band; this amazing antenna design also maintains better than 20 DB front-to-back ratio over the entire frequency range of the two channels for which each antenna is designed.

The Advantages of a New TRIO 2-Channel Antenna;

- Provides gain on both channel 4 and 5 (or 7 and 9)
- Equal to Any Two conventional 4-element yagis!
- One bay replaces bulky stacked array!
- One lead replaces old-style 2-lead systems!
- Less weight-per-gain than any other TV antenna!
- Greatly reduced installation costs for complete TV coverage!

How It Works

Antenna consists of 4 elements whose functioning is different on the two channels. For example; in Model 445, the elements, on channel 4, act as reflector, dipole, director, director, in that order; while on channel 5, the same elements act as reflector, reflector, dipole and director. Careful design ensures proper impedance match with standard 300 ohm lead.

Eliminates Co-Channel Interference when used in "Controlled Pattern" system.

The new TRIO 2-Channel Yagi is available in single bay, conventionally stacked 2 bay array for additional gain and as the famous "Controlled Pattern" system utilizing 2 bays, off-set stacked and tuned with the remarkable TRIO "Phasitron" that completely eliminates Venetian-Blind Effect when caused by co-channel interference!

- Model 445 — Single bay Yagi for Channels 4 and 5.
- Model 445-2 — Conventional 2 bay stacked array for Channels 4 and 5.
- Model 479 — Single bay Yagi for Channels 7 and 9.
- Model 479-2 — Conventional 2 bay stacked array for Channels 7 and 9.
- Model 645 — "Controlled Pattern" System for Channels 4 and 5.



RCA **RADIO and TELEVISION**
Thorough Training in All Technical Phases
APPROVED FOR VETERANS
WEEKLY RATES DAYS—EVENINGS
FREE PLACEMENT SERVICE FOR GRADUATES
For Free Catalog write Dept. RN-50
RCA INSTITUTES, INC.
A Service of Radio Corporation of America
350 West 4th St., New York 14, N. Y.

COUPON-OF-THE-MONTH

TUBES—STD. BRAND 5Y3 GT.....	3 for \$0.99
TUBES—STD. BRAND 12SQ7 or 12AT6.....	2 for .99
VOL. CONTROLS—STD. BR. .5 Meg. W. SW.....	3 for .99
CONDENSERS—40-40 Mfd. 150V.....	2 for .99
CONDENSERS—20-20 Mfd. 150V.....	2 for .99
LOOP ANTENNA—HI GAIN (5"x8").....	3 for .99
I.F. COILS 455 KC (1 1/4"x2 1/2").....	3 for .99
OSC. COILS 455 KC (for 12SA7).....	4 for .99
BY PASS COND. KIT—18 Ass'd.....	.99
DIAL CORD KIT—100 ft. Ass'd. & 6 Springs.....	.99
GRILLE CLOTH—6 Ass'd. 6"x6" & 10 Knobs.....	.99
● COMBINATION KIT—All Above Items—Only.....	10.00

WITH THIS COUPON—ORDER AT ONCE
Write for Monthly Coupons and Bulletin
RADIO DISTRIBUTING CO., Pasadena 18, Cal.

DIAMOND Playback Styli

We can install broadcasting-station-quality diamond tips in your own cartridge or removable stylus assembly, or furnish a complete new stylus.

Radio stations, wired-music services, commercial installations, recording studios, professional engineers and musicians have been using nothing but diamonds for years because they know that diamond styli ensure the longest record life and highest-fidelity reproductions, as well as being the cheapest needles in the long run. One diamond, costing less than ten sapphires, will outlast between 67 and 150 sapphires! Reprints of articles reporting the results of impartial investigations and tests on phonograph needles are available on request.

When writing please be sure to mention make and model of your cartridges. Information and prices will be furnished without obligation. (We can also supply record changers and LP players already equipped with diamond styli).

TELEVEX 474 1/2 WEST 238TH ST.
NEW YORK 63, N. Y.

ANNOUNCING NEW, MODEL 1401

Plays 10½" Reels!



Complete, for console installation with single or dual track heads:

\$345⁰⁰

CONCERTONE

■ The professional quality tape recorder you have been waiting for! NAB standards; triodes throughout; 40-15000 cycles at 15", 40-8000 cycles at 7½". Three motors; flutter less than 0.1%; signal-to-noise better than 50 db. Three heads for simultaneous erase, record, playback. Quick change from single to dual track. Write for booklet.

FISHER RADIO CORPORATION • Distributors • 39 E. 47th St., N. Y.

someone whose vocal mannerisms are completely familiar.

Presence

"Presence" is a relatively new term popular in advertisements of loudspeakers and amplifiers. Definitions and analysis may differ. Presumably the term refers to that quality which gives the illusion that the listener is actually in the room in which the program is originating. Several factors combine to produce this quality. Naturalness, of course, is one of them. The audibility of various accompanying noises, such as breathing, is another. But the most important, perhaps, is the quality of room resonance.

There are always two rooms involved in the reproduction of recorded and radio sound—the room in which the program originates, and the one in which it is reproduced. It is the resonance of the original room, the studio, we are trying to reproduce. But since living rooms have acoustics which are very different from studios or concert halls, it is obviously a difficult thing to reproduce the room resonance of the original room or studio.

Moreover, the amount of room resonance present in a radio program or recording will vary widely. Up to a few years ago most radio and recording studios were very dead and the program incorporated very little resonance. Lately many radio programs and recordings contain a degree of room resonance. The degree of presence will, therefore, necessarily vary not only with the acoustics of the living room but also with the program material.

Under today's conditions it is probably best that the room in which modern musical radio programs and records are reproduced, should be slightly on the "dead" side. If the room is too live, the room resonance it contributes may so modify the total effect as to reduce the illusion of presence.

Keeping these things in mind, the first thing we can say about testing or judging sound systems for presence, is that in a given room and with a given program source, the better the amplifier—in the respects already considered—the less the apparent or superficial room resonance.

Room resonance consists largely of the addition, to the original sound, of echoes reflected from walls and other objects. But echoes are also added by transient distortion or hangover. An amplifier with good definition has a good transient response and little or no hangover; therefore, it contributes little or no artificial resonance.

This does not mean it will have less presence. No real investigation has been made of all the ways in which room resonance is expressed in the total sound picture. Part of it consists of the echoes in the same frequency range as the original sound but with phase and amplitude differences. Part, however, consists of various combinations and beat tones, especially of very

RADIO & TELEVISION NEWS

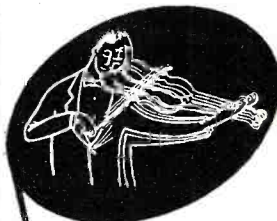

a message to music lovers and

record playing enthusiasts!

Your records, (LP's or Standard) need not produce fuzzy, noisy, distorted music. Inherent in their sound grooves is fine musical realism of concert hall quality that can be recreated by record players equipped with fine audio components: pickup, arm, compensator, preamplifier, etc. Such components by Pickering are the finest available: the choice of engineers, leading record critics, music lovers and specialists in the production of custom record playing systems.

Pickering High Fidelity Components are available through leading jobbers and distributors everywhere; detailed literature will be sent upon request.

Pickering & Co., Inc.
Oceanside, N. Y.

For the utmost in quality specify Pickering Audio Components!

low frequency, which would not be present if there were no reflected component. The more faithful the reproducing system, the more faithfully it will reproduce these complex patterns which account for the total room resonance and presence qualities. And even if there is less artificial resonance, the rendition of the resonance in the original program material is more faithful and natural.

Many of the RCA 45 r.p.m. records and LP's have excellent innate room resonance and presence. The best example of recorded presence we know of, however, is the recording of "Green-sleeves" with Dorothy Shay. Perhaps because it is recorded in a small studio, comparable in size to the average living room, the effect of presence on a good sound system is really remarkable. Those midnight pick-ups of bands from the local nightclubs are often excellent for checking or demonstrating presence.

Dynamic Range

Because of the almost universal use of limiters and compressors in radio and recording, the dynamic range of most programs will be less than 40 db. This is considerably less than that of a live orchestra. As a result, the home sound system will seldom be called upon to deliver high output peaks. Assuming a reasonably efficient speaker system, an output of 5 watts will not be exceeded once a month. Still, the system should take those peaks cleanly and without producing excessive distortion.

A simple test for this is to use that Gershwin "Concerto" recording of the opening kettle drums. Raise the volume until the kettle drum bursts push the amplifier to nearly maximum output. Now listen for cleanness in reproduction, as compared with reproduction at low volume levels. Also for traces of echoes or hangover. If the system will reproduce those bursts cleanly, sharply and without generating echoes and bad distortion, it will easily meet the dynamic range problems of everyday listening.

To summarize then, in subjective tests of sound systems look for these factors: (1) Freedom from fatigue; (2) A clean, sharp, distortion-free high frequency response, without fuzz or harshness; (3) a natural bass in which the fundamental is dominant. Such a bass is duller than an artificial bass, more vibrant and will move more; (4) Good definition which is expressed by the distinctness with which the separate components of the sound pattern stand out from each other; (5) Naturalness of the instruments or voices; (6) Presence, or the illusion of being present in the room in which the program is originating. In a living room the illusion may be more like that of hearing the orchestra in the next room, or through a door; (7) The system should take peaks without breaking up and any distortion ought to be confined to the upper 3 or 4 db. of the dynamic range. —50—

November, 1950

LOOK! ACT! SAVE!

VHF GROUND STATION

(100 to 156 MC — 115-230 V. AC 50/60 CY)

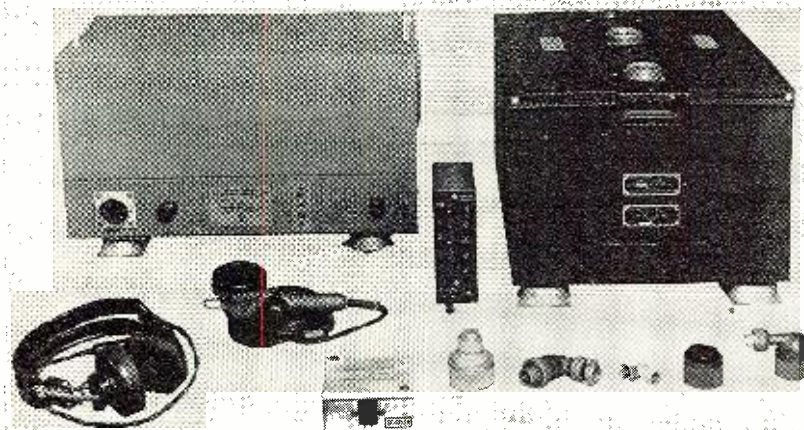

Top value in every unit. New—guaranteed satisfactory operation. Expertly packed for export.

PRICE ONLY \$290.00
(F.O.B. Los Angeles Factory)

COMPLETE, NEW, SURPLUS RADIO

Guaranteed to Meet Original Manufacturers' Specifications.

ARB Receiver, RCA—195 mc to 9.05 mc
BC 375E Transmitter—200 kc to 12.5 mc
SCR 522 Aircraft Radio—110 to 156 mc
SCR 536 Handi-talki Radio—3.5 to 6mc
BD 72 Telephone Field Boards—12 line switching
AN/APN-2 Aircraft Radar DME—200-400 mc
Aircraft Radio Test Equipment—VHF
W110B Field Telephone Wire—2 cond. twisted
TBS Shipboard Antenna—60-80 mc
A-101 Ground Antennas—100-156 mc
A-104-A Aircraft Antennas—100-156 mc
AN/ARN-7 Automatic Radio Compass 100 kc—1750 kc
ARC-1 VHF Aircraft Radio 10-20 channel—100-156 mc
ARC-3 VHF Aircraft Radio 8-32 channel 100-156 mc
SCR-284A Portable Field Radio 3.8—5.8 mc
TDE-2 Shipboard Transmitters—300 kc—18 mc
TCS Ship Shore Radio—1.5—12 mc
TAJ Shipboard Transmitters—175-600 mc
TBL Shipboard Transmitters—175-600 mc
TBK Shipboard Transmitters—2-18.1 mc
TBS Ship Shore Radio—60-80 mc
BC 610 Hallicrafter Transmitters—2-18 mc
VHF Ground Direction Finders—100-156 mc
BC639 VHF Tuneable Receivers—100-156 mc
HF Airport Ground Stations—1.5-30 mc
APN-9 Loran Receivers
SCR718 Hi-Range Altimeters
O-16/ART-13 Collins Low-frequency Oscillators

We provide export license, freight forwarding and export packaging at no extra charge.

Continuous Rated
RA 62 VG Power
Supply. SCR 522
Transmitter Re-
ceiver with A-101
Gd. Plane Ant. In-
struction Manual
Included.



Advance with ELECTRONICS CITY

You need firm grasp of fundamentals to keep pace with these complex, fast-growing fields. In thorough 2-year course learn electricity, electronics, physics, mathematics, drafting, etc. Employers want Franklin graduates. Coed. G.I. approved. Day, evenings, 43rd year. Write for Catalog.

FRANKLIN TECHNICAL INSTITUTE
46 Berkeley Street Boston 16, Mass.

BARGAIN HUNTING?
RADIO SERVICEMEN!
Write for SENSATIONAL CATALOG
HENSHAW RADIO SUPPLY
3619 TROOST KANSAS CITY, MO.

WAR EQUIPMENT MAIL SALE!

SAVE up to 70% on Electronic, Radio, Mechanical Equipment!

For home experimenters, laboratories, schools, etc. New, fully guaranteed. Fraction of original cost. 100s of items including:

- 2500-watt A-C Power Plants \$279.00
 - G.E. Selsyns (pair) 3.39
 - Raytheon 110-v Electronic Timer 8.94
 - Meg-A-Lite Continuity Condenser 110-v Tester 1.99
 - Resistor, Capacitor Asst. 4 lb. 1.89
 - City Desk Telephones 5.98
 - Photo Cell Light Control Kit 4.87
 - Other bargains—Compressors, Paint Spray Guns, Engines, Pumps, Tools, etc.
- 18 yrs. in business in Lincoln. Satisfaction Guar. We prepay all shipments. Card brings catalog, 100s bargains.

BURDEN SALES COMPANY
853 "O" St. Lincoln, Nebr.

HIGH
FIDELITY
is here!

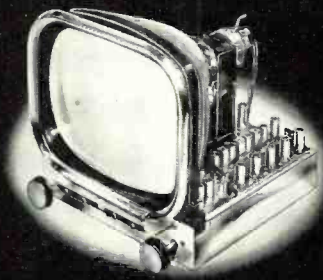

TWO BRILLIANT NEW
CUSTOM CHASSIS —

Now, for the first time, you can enjoy the finest television and FM—plus high fidelity audio—all in one superbly-designed instrument! Now, at last, custom builders and electronics enthusiasts can choose the Craftsmen Television which best suits their needs. SEE them! HEAR them! Above all—COMPARE them!

The RC-101

An outstanding new high fidelity custom video tuner with the same fine, big-picture quality and sensitivity as its famous predecessor, the RC-100! Features include keyed AGC and booster switch, plus new, double-shadow tuning eye for precision tuning. 20-20,000-cycle audio output permits remote hook-up with high fidelity audio and FM-AM tuners. Turret-type channel selector.

The RC-200

Here, at last, is a TV-FM-high fidelity audio receiver which, in one chassis, combines true high fidelity television and FM reception! Has all features of RC-101, plus 5-watt, push-pull high fidelity audio system and coverage of FM band. Continuous-type tuner and tuning eye permit 1-knob control of TV, FM or phono. Both chassis finished in polished chrome.

Write for information—or send 50c for instructions and schematics.

THE RADIO

craftsmen
INCORPORATED

Dept. R-11, 1617 S. Michigan Ave., Chicago 16, Ill.

THE AD-VISER

3

HEADLINES SHOULD PROMOTE INTEREST

By
IRVING SETTEL

AS FAR as the radio and television merchant is concerned, there is but one justification for advertising: immediate and profitable sales! This means that your advertisement must get readership, must convince the readers, must get them to act upon your suggestions. Obviously then, the first and most important problem confronting the advertiser is to get attention.

Competition within a newspaper is terrific. The average person buys a paper to read the news, to enjoy the comics, the features, and columns. The advertisements within the pages are incidental and often undesirable. It is necessary, therefore, to entice the readers from what *they* want to read to what *we* want them to read. Assuming that this can be accomplished, we find another group of competitive factors . . . other advertisements! Every advertiser is fighting for attention. All are trying to sell. All are demanding the reader's attention.

What makes the reader leave the news items, take his eyes from the comic pages, give up his favorite columnist? *The headline in the advertisement!* What element gets the reader to stop as he rushes through his paper? *The headline!* What, within the ad, offers enough interest to get the potential customer to read your copy? *The headline!*

There is no doubt about it, the headline is the most vital part of your advertisement. Not many retailers appreciate its value. Thousands of dollars are spent on advertising, on sparkling copy, and fine illustrations. But often the headline is neglected. Yet, if the headline does not attract, the copy will not be read. While the illustration does carry a good portion of the attention-getting load, it cannot do its work without an effective "head."

There are many kinds of headlines. There are curiosity headlines, news headlines, selective headlines, etc. Tests prove, however, that the one theme within the headline which gets the most attention is *self-interest*.

Every reader is interested in him-

self first and foremost. Everyone wants to better himself. Everyone wants health, happiness, and success. If you can offer this in your headline, you'll get his attention. You must talk in terms of what he wants, you must tell him how *he* can benefit from using your product. The result? Plenty of sales!

Self-interest headlines are the kind that get attention. Each "head" should offer as complete a thought as possible. If the reader should skip the body, and often he does, he'll be left with a valuable impression which may bring "delayed action." Remember, the best headlines offer the reader something he wants! But too, it must be simply written and understandable to every potential customer. You must catch the reader's eye, with simplicity and directness. You've got to sell, sell, sell in your headline just as much as in your body copy.

Effective Headlines

Let us review some of the rules which make for effective headlines:

1. Appeal to the reader's self-interest. Offer him something *he* wants.
2. Make your appeal believable. When you make an offer, it should be one which can be followed through in your body copy . . . and in your store.
3. Curiosity headlines are effective when combined with self-interest. Don't use curiosity alone.
4. Use a positive, cheerful approach wherever possible.
5. Before writing your headline, ask yourself what would make *you* read the ad and act upon the advertiser's suggestions. This may give you the key to the correct appeal.
6. Make your headline short and simple, easy to understand, sincere, and convincing.

Can a successful formula be applied to writing headlines? The answer is "yes," with reservations. Most good headlines are inspired. They come from the heart *and* the head of the copywriter and appeal to the heart and head of the reader. However, there are formulas which might start the train of thought in the right direction. There are also formulas which have been used successfully in the past and can be applied to your business. Here are a few of the most practical examples:

1. Start your headline with the

word "HOW." People are always interested in learning *how* to do things. Examples include:

HOW TO SAVE \$15 ON YOUR NEW TELEVISION CONTRACT!

HOW TO ADD PLEASURE TO YOUR HOME!

2. When offering something new, start with the word "NEW" or "ANNOUNCING."

NEW... AN EASY WAY TO BUY A TELEVISION SET!

ANNOUNCING... SAVINGS UP TO 50%!

ANNOUNCING... OPENING OF OUR TELEVISION SERVICE DEPARTMENT!

3. One word headlines are effective if they are thoughts within themselves and are printed in large bold letters:

REDUCED!

FOUND!

SAVE!

Sub-headlines are usually required with single word "heads" to amplify the meanings and thoughts.

4. Use the *question* headline to arouse curiosity but be sure to include the self-interest theme.

IS YOUR TELEVISION SERVICE COSTING TOO MUCH?

WOULD YOU LIKE TO SAVE 25% ON YOUR NEW RADIO?

5. Selective headlines with the element of self-interest will get attention:

TO WOMEN WHO WANT TO SAVE MONEY!

TO MEN WHO LIKE TO STAY HOME EVENINGS.

Originality and common sense must be included in all your headlines. Your own business experience and judgment help a great deal. But time must be spent to get the best "head" for you must not forget that it carries the heaviest load in attracting attention.

-30-

One of the 114 microwave relay reflectors being built by General Electric for the communications system the company is supplying Transcontinental Gas Pipe Line Corp., to extend over its 1840-mile pipe line now under construction between Houston and New York. Project Engineer M. F. Davis finishes installation of the dipole prior to tests being made at G-E.



November, 1950

"BETTER TV RECEPTION

in fringe and low-signal areas"

By W. W. SMITH, author of the "ANTENNA MANUAL"
and R. L. DAWLEY, editor of the "RADIO HANDBOOK"

With this book, many successful installations have been made where all previous attempts failed. Gives you *practical* information on all "fringe area" problems of TV installation and reception. Selecting the best transmission lines boosters and receivers; eliminating "ghosts"; minimizing fading; improving receiver performance; reducing TV interference; evaluating antennas... all this and more, including full information on rhombics, is yours in this new book... a "must" for every TV man and every TV fan!

\$2.50 per copy (paperbound)
By mail from us, \$2.60 postpaid.

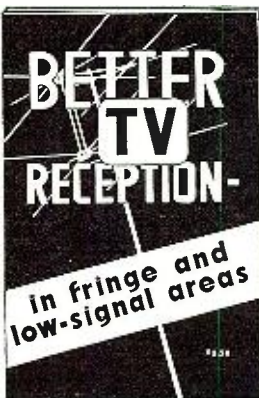

AT YOUR FAVORITE DEALER or direct by mail from
Editors and Engineers 1302 KENWOOD ROAD Santa Barbara CALIFORNIA

POWER!

Your ad in the Classified Section of RADIO & TELEVISION NEWS is read by the largest audience in the field—monthly circulation—over 200,000.

TELEPHONE WIRE

Sensational purchase means new low prices!

Telephone Handsets: TS-13, TS-15, TS-9... \$9.95 ea.

Sound Powered Handsets: \$12.50 ea., \$24.50 pr.

This is genuine W110B Army Field Wire. It comes to you on original steel reels, 2-conductor, twisted pair. Each conductor has 3 copper, 4 steel strands for extra tensile strength. Rubber insulated. Impregnated fabric outer covering.

NEW, unused, excellent condition

per Mile (Wt. 160 lbs.)... \$16.00

1/2 Mile (Wt. 80 lbs.)... 8.25

NEW, unused, good serviceable condition, per Mile... \$12.50

1/2 Mile... 6.75

Excellent for all-weather, all-purpose communication. Used extensively by telephone companies, industry, engineering projects, ranches, etc., for extended field communication systems.

NEW W130 Lightweight Assault Wire

1/2 mile reels (2600 ft.) wt. 16 lbs.... \$9.95

1/4 mile reels, wt. 8 lbs.... 4.95

All prices FOB Sacramento. No COD. (California residents add 3% for sales tax.)

Send check or money order to LORIS SALES
P. O. Box 1896-M-11, Sacramento, Calif.

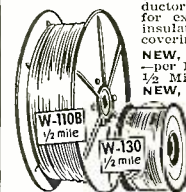

179

CONVERT TO BIG SCREEN TV

Wholesale Radio Has Everything
You Need for Easy Conversion!

FOR 14" SCREENS



Shelden Rectangular Tube 14BP4
G.E. Deflection Yoke M-D-70
For 14" or 16" Tubes 4.95
Focus Coil 202D-2 6.60
Mounting Brackets for 202D-2
Type BR-67 2.65
14" Plastic Mask, Rectangular 3.45
Deluxe Hi-Sweep Kit B 9.45
(See Details Below)

FOR 16" SCREENS



G.E. Rectangular Tube 16KP4 \$37.00
70° Deflection Yoke MD-70-F
Greater deflection sensitivity for
16" rectangular tubes 6.00
Focus Coil 202D-2 6.60
16" Plastic Rectangular Mask 4.75
Mounting Brackets for 202D-2
Type BR-67 2.65
Deluxe Hi-Sweep Kit B 9.45
(See Details Below)

Hi-Sweep Voltage Multiplier Kit!



FOR CONVERTING TO 14", 16" or 19" TUBES

For converting 630 or similar
type sets. Supplies 14 kv with
full sweep using a single 1B3
rectifier. Kit complete with
77.7 ohm byback transformer, special
width coil and all other com-
ponents necessary to complete
your voltage multiplier kit. Plus
wiring instructions. Type A for
16" round tubes. Type B for
14-16 rectangular and 19"
tubes **\$9.45**

Get Best Pictures with Snyder TV Antennas

Lowest Price Conical Array Can Be Stacked for Fringe Areas 8 Interchangeable Elements

Covers complete TV-FM band. Hi-tensile 3/8" alu-
minum alloy elements.
Includes mast clamp for
use with poles up to
1 1/2" di. Can be used
with any type lead-in 72
to 300 ohms. Model
XA-44 less
mast **\$3.95**



DOUBLE CONICAL LAZY XX

Extremely hi-gain. All TV Channels & FM. Com-
pletely pre-assembled. Three 3 1/2' ft. masts and
adj. mounting base included. Model TX-2 **\$15.95**

HI-LO FOLDED DIPOLE ARRAY

Two folded dipoles, high & low, with reflec-
tors. Less Mast AR-21 **\$4.39**

TV HI-BAND ARRAY

Folded dipole and reflector. For channels 7
to 13. Less Mast. HF-3 **\$1.49**

INLINE ANTENNA

Highly directional. Hi-Gain. All channels. Com-
plete with mast. TV-16 **\$8.65**

STEEL EXTENSION POLES

10 Ft. long, 1 1/4" di. **\$1.49**
5 Ft. long, 1 1/4" di. crimped end. **.89**
3 1/2 Ft. long, 1 1/4" di. crimped end. **.69**

Hi-Gain! Equal to 2 Ordinary Boosters! ASTATIC TV BOOSTER



Four 6AK5 tubes. 2 in high band
2 in low band. Provides 2 tuned
circuits and 2 broad band circuits
on all channels. Dual tuning con-
trols allow separate tun-
ing for picture and sound. **\$29.70**

TECHMASTER TV BOOSTER KIT

Complete with tube, pre-
aligned coils, pre-stamped
chassis and handsome
cabinet .. **\$9.95**

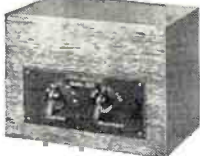

Improve TV reception in low signal low terrain and
fringe areas by building this latest design booster.
Tested to reduce noise from 3 to 5 db. Get brighter,
sharper pictures you hardly thought possible. Sim-
plified step-by-step wiring instructions included.

WRITE FOR FREE "FYI" BULLETIN
Address all orders to Dept. RN-11
or call Muberry 2134

**WHOLESALE
RADIO PARTS CO., Inc.**
311 W. Baltimore St.
BALTIMORE 1, MD.

Hum Control (Continued from page 58)

120 cycle note. Hum due to inade-
quate cathode bypassing, or an un-
grounded heater supply, is often an
asymmetrical 60 cycle wave with sharp
corners, Fig. 8B.

Inductive hum picked up by trans-
formers is very rich in harmonics (Fig.
8C) but free from sharp peaks and
spikes. It has a sort of musical sound,
like the hum sometimes heard on tele-
phone lines.

Fluorescent lamp interference is
characterized by sharp spikes and
hash. Fig. 8A shows a bad case of
it. The frames of the fluorescent
lamps that are placed near the bench
should be well grounded, and the
lamps themselves kept at least a cou-
ple of feet from the work.

Miscellaneous Sources

Broadcast receivers sometimes ex-
hibit hum only in the presence of a
received carrier. This is due to recti-
fication of r.f. picked up by the house
wiring, by copper oxide in loose con-
nections therein. The rectified signal
is modulated by a.c. The remedy is to

eliminate r.f. signals getting into the
set from the a.c. line, by grounding
both sides of the line to the chassis
through condensers of about .005 μ fd.

The v.h.f. oscillators, such as oscil-
lators in FM and TV receivers, ac-
quire a 60 cycle frequency modula-
tion in circuits where the cathode is
"hot" to ground and the heater is not,
i.e., where cathode and heater are not
at the same r.f. potential. The me-
chanism of this effect is not under-
stood. The cure is to use a circuit
where cathode and heater have the
same r.f. potential. It is satisfactory
to use either a grounded-cathode os-
cillator circuit, or a "hot" cathode cir-
cuit where cathode and heater are
connected together, feeding the free
side of the heater through an r.f. choke.

Center-tapped heater supplies are
not too feasible in systems involving
high-gain, multi-stage r.f. or i.f. am-
plifiers, because one side of the heater
has to be grounded at each tube,
preferably right to the chassis, to pre-
vent regeneration by coupling through
the common heater wiring.

REFERENCE

Dickerson, A. F.; "Hum Reduction," Elec-
tronics, December 1948, pp. 112-116.

-30-

Fig. 8. (A) Noise pickup from fluorescent lamp. (B) Heater-cathode leakage current. (C) Inductive hum pickup by audio transformer. (D) Capacitive hum pickup from a.c. wiring.

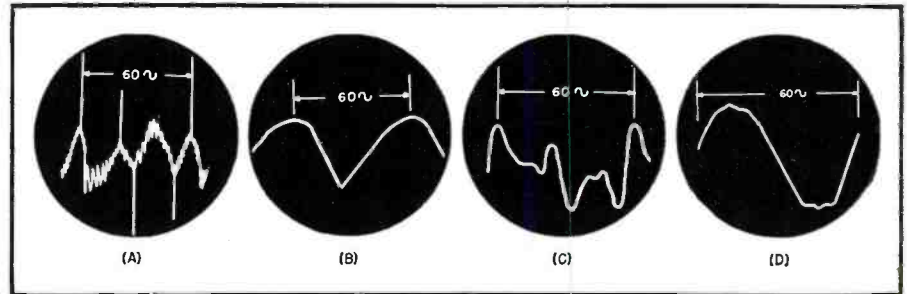

Officers of the 1951 Radio Parts & Electronic Equipment Shows recently met in
White Sulphur Springs to make plans for next year's expanded program of displays,
exhibits, and meetings. From left to right are: J. J. Kahn, Standard Transformer Corp.,
president; L. W. Howard, Triad Transformer Mfg. Co., secretary; S. J. Spector, Insu-
line Corp. of America, vice-president; and C. A. Hansen, Jensen Mfg. Co., treasurer.



International Short-Wave

(Continued from page 154)

Pakistan—Radio Pakistan noted with news 0700 on 7.140, approximately 11.54, and 11.845. (Sanderson, Australia) The 11.54A outlet is best here in West Virginia at that time.

Panama—HP5J, 9.607, Panama City, noted with music 1930, weak and with QRM from BBC. (Cox, Delaware) HOLA, 9.505, Colon, heard in *English* 1600-1730. (Colby, Conn.)

Paraguay—ZPA1, 6.275, Asuncion, heard in Sweden quite well at 1950. (Orhwall) ZPA5, 11.945, Encarnacion, is a good signal 2000-2100. (Sutton, Ohio)

Peru—Radio America, OAX4W, 9.63, Lima, noted with good signal around 1815 to fading around 1900; all-Spanish. (Boice, Conn.) Radio Nacional del Peru, OAX4Z, 5.895, signs off 2330, good level; then OAX4V, Radio America, 5.907, comes into the clear with good but weaker signal; latter leaves the air 0100. (Callarman, Oregon)

Philippines—DYB2, 4.98, Bacolod City, noted 0830 with classical music; DYH2, 6.140, Cebu City, heard 0830 concluding program of dance music; DZH6, 6.030, Manila, the Far East Broadcasting Company, heard 0830 with news in parallel with DZH7, 9.73. (Neeley, Oregon) DZH2, 9.64, Manila, noted signing off 1100; DZH3, 9.500, heard 0500. (Baker, Calif.) DZH5, 9.69, heard 0530 with music, then news; sponsored. (Sanderson, Australia)

DYH4, 6.055, noted 0615 with music. (Sanderson, Australia) This one verified from Dumabuete City; has been operating *only* at 0500-0700 on DYH4 and DYSR (840 kc.), but schedule by now probably will have been extended to four hours daily; power is 300 w., with V-beam on Luzon; location was first believed to be Iloilo City. (Cushen, N. Z.)

Poland—Warsaw now has a *second* transmitter on the air; uses 6.215, 7.205, 9.252; *English* is at 1215-1245 on 6.215 and 9.525, at 1330-1400 on 6.215 *only*. (Radio Sweden) The 9.252 channel has been heard in New York to closing 1815 and again from 2000, good level. (Bellington)

Portugal—Lisbon's *new* channel on approximately 15.02 is heard afternoons in dual with 11.04 to 1530 closedown; these outlets come back on the air 1600-1800 final closedown. Is also heard on 15.02 early mornings EST. (Bellington) *Radio Sweden* lists the 15.02 outlet as CSA34.

Roumania—At the time this was compiled, *Radio Bucharest*, 9.252, was beginning to come through again with news 1500; heavy CWQRM on channel. (Cox, Delaware)

Saudi-Arabia—Djeddah, approximately 3.91, heard through QRM at 1200-1330 (some days late as 1400); clock strikes at 1330; male and female announcers. (Hannaford, South Africa) Heard by Pearce, England,

November, 1950

TV's T-formation



New smooth action! New thrilling performance! Greater all-round team effectiveness for football gridirons and television receivers with the T-formation — Thomas Tubes.

Banish the galloping ghosts and put your receivers in the clear for consistent gains in popularity and sales. Try television's famous T-formation—and we do mean Thomas! There are no finer television picture tubes.

THOMAS ELECTRONICS, Inc.

118 Ninth Street

Passaic, New Jersey



The December issue of **RADIO & TELEVISION NEWS** will be on sale December 1. Be sure to reserve your copy with your Newsdealer.

RADIOMEN! ELECTRICIANS! Learn How To Run **YOUR OWN SERVICE SHOP**

WITH THIS VALUABLE BOOK!

Special introductory offer! Get this latest library edition of "Starting & Operating A Profitable Electrical Or Radio Business"—for only 75c. Hundreds sold at \$1.75. You save \$1.00! Fully explains how to start your own shop on small investment. Covers financing, location, record-keeping, pricing, advertising, merchandising. Easy to understand, fully illustrated. 296 pages, case bound. Offer limited. Send only 75c to:

Book Division, COVNE ELECTRICAL & TELEVISION-RADIO SCHOOL, 500 S. Paulina St., Dept. BO-T3, Chicago 12, Ill.

Regular \$1.75 Edition
Now Only **75¢** (Postpaid)

TWIN-TRAX* TAPE RECORDERS
designed... **ENGINEER** in mind

A COMPLETE SERIES

... of high-fidelity, dependable tape recorders—from transport mechanisms to highly specialized instruments, including the one YOU want. Write today for catalog 5101. Includes ALL technical specifications and direct factory prices.

AMPLIFIER CORP. of AMERICA
398-2 Broadway, New York 13, N. Y.

*Trademark Reg.

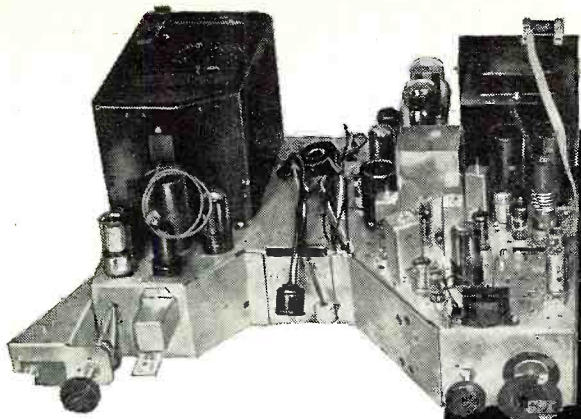

Not a kit, but a complete chassis assembled and checked by professional experts

14 reasons why our
RCA # 630 chassis
is your best TV buy!

Contact us immediately for low price of this unbelievable buy!

Traditel

DISTRIBUTORS, INC.

Dept. 11N, 1001 First Avenue Asbury Park, New Jersey
Asbury Park 2-7447. In New York, WOrth 4-1197

1. 30 tubes—27 tubes, 3 rectifiers
2. AFC horizontal hold, featuring Syncrolok
3. High voltage doubler circuit
4. Maximum brilliance with any picture size up to 19"
5. Co-channel sound, featuring good limiting for maximum noise immunity
6. Keyed AGC (using extra 6AU6 tubes), minimizes airplane flutter, keeps picture level constant and uniform when switching from channel to channel
7. Overall band width four m. c. for maximum definition and picture crispness
8. Original 630 sync chain for maximum picture stability
9. Molded condensers throughout
10. Full complement of electrolytics as specified in original design
11. Focus coil and yoke assembly with removable plugs for easy servicing
12. Top quality video amplification assuring good contrast range for full "blacks and white"
13. Same chassis used in highest-priced sets and custom installations
14. Complete with mounting hardware ready for installation

EASY TO LEARN CODE

It is easy to learn or increase speed with an Instructograph Code Teacher. Affords the quickest and most practical method yet developed. For beginners or advanced students. Available tapes from beginner's alphabet to typical messages on all subjects. Speed range 5 to 40 WPM. Always ready—no QRM.



ENDORSED BY THOUSANDS!

The Instructograph Code Teacher literally takes the place of an operator-instructor and enables anyone to learn and master code without further assistance. Thousands of successful operators have "acquired the code" with the Instructograph System. Write today for convenient rental and purchase plans.

INSTRUCTOGRAPH COMPANY

4711 SHERIDAN ROAD, CHICAGO 40, ILLINOIS

TECHNICAL DECALS



GIVE PRODUCTION LINE APPEARANCE TO YOUR ELECTRONIC EQUIPMENT!

EASY-TO-APPLY! • PERMANENT!
SAVES TIME! • SAVES ERRORS!

Complete decal sets for labeling Transmitter, Receiver, Audio, Instruments, Television and Dial markings. Each set labels several items. State type of decal set and color preference (black or white letters) with order. See your local jobber. If he cannot supply you—order direct and include his name and address. Price per set . . . \$1.35 net.

TEKNI-LABELS COMPANY DEPT. R • 732 SO. VICTORY
BURBANK • CALIFORNIA

GET YOUR F. C. C. LICENSE AMATEUR OR COMMERCIAL

TRAIN BY **PHOTOSOUND!**



CUTS HOME-STUDY TIME IN HALF!

Twice as fast as ordinary home-study methods: Cuts training time in half! You learn only the essential facts that lead directly to your F.C.C. Amateur or Commercial License. With "PHOTO-SOUND" you not only SEE the material, but you actually HEAR YOUR INSTRUCTOR'S VOICE!

Average pay reported by F.C.C. nationwide survey is \$3,000 to \$7,500 per year for F.C.C. ticket holders. Employers want F.C.C. Licensed technicians—an F.C.C. Ticket is proof of technical ability. Get YOUR F.C.C. License the EASY WAY, with Amazing "PHOTO-SOUND" Home Training.

ELECTRONIC TECHNICAL INSTITUTE
769 VENICE BLVD., LOS ANGELES 15, CALIF.

FREE!

ALL THREE VALUABLE BOOKLETS!

"OPPORTUNITIES IN ELECTRONICS"

F. C. C. EXAMS MADE EASY

SAMPLE F. C. C. EXAM

Mail Coupon at Once!

ELECTRONIC TECHNICAL INSTITUTE Dept. RT-110
769 Venice Blvd., Los Angeles 15, Calif.
Gentlemen: Please send me free of charge your three-in-one booklet, "F.C.C. Exams Made Easy", "Opportunities in Electronics", and "Sample F.C.C. Exam." I am interested in the F.C.C. AMATEUR () COMMERCIAL () Licenses.

NAME _____ AGE _____
ADDRESS _____
CITY _____ ZONE _____ STATE _____

around this time on approximately 5.975.

Bellington, N. Y., has received a most interesting letter-verification from Djeddah's chief engineer, John E. Morrow (formerly W9RAT—the "Old Kansas Rat"). The transmission at 2300 is heard by Bellington best on 11.75, but other channels audible include 11.85, 11.95, and 9.635; Morrow also listed 3.950.

South Africa—Since SABC no longer takes BBC news relays, it has set up its own news services as follows—*English*, weekdays, 0015, 0615, 1100, 1200, 1515, Sundays 0100, 0600, 1100, 1515; *Afrikaans*, weekdays, 0000, 0630, 1115, 1215, 1510, Sundays 0110, 0545, 1105, 1510. (Copenhagen DX broadcast) ZRB, 9.11, Pretoria, noted 0015 with news. (Bellington, N. Y.)

Southern Rhodesia—Salisbury has been testing a 1 kw. transmitter on 9.490 and an 8 kw. one on approximately 6.078; regular channel remains 3.320. (Radio Australia) Heard by Pearce, England, on 3.320 to 1501 when signs off with "God Save the King"; local news 1315, weather, then SABC news.

Spain—Madrid, 9.369, is good signal in Connecticut daily 1800-1840 in North American (*English*) beam; on Sundays has a mailbag program called "Forty-Minute Trip Around the World"; an interesting talk on Spanish Africa is presented each Monday. (Boice) Still heard with news for Europe 1515. (Fargo, Ga.) EAJ3, *Radio Mediterraneo*, 7.037, Valencia, has *English* lessons on Tues., Fri. 1440.

Syria—*Radio Damascus* verified via airmail; gave schedule of Thursday 2345-0300, 0400-0800, 1100-1700; Saturday 2345-0300, 0430-0800, 1100-1800; other days 2345-0100, 0600-0800, 1100-1700; present frequencies were listed 6.000, 9.550, 12.000; news 0600, 1630 daily. (Cushen, N. Z.)

Tahiti—A recent letter from *Radio Tahiti*, Papeete, stated that by the end of 1950 two transmissions are to be radiated for Oceania, around 1700-1745, 2300-2345; will move from present 6.980 to approximately 7.300 for these transmissions; early in 1951, will use 9.053 (instead of current 12.080) with 24 kw. for broadcasts to the United States at least semi-weekly and possibly daily. New studios and equipment are being installed. (Russell, Calif., Cushen, N. Z.)

Taiwan—Neeley, Oregon, says Taipei, 12.235, is QRM'd by Moscow and WLWO, 15.23, to around 2245; is scheduled 2200-2400, first hour in *English*. *Radio Australia* reports this one back on 11.735 mornings EST; should have news either 0515 or 0615.

BCAF, 8.996, Teipeh, is heard to 1113 sign-off, weak; all-Chinese; CWQRM from numerous U.S. military outlets. (Neeley, Oregon) Noted on Wednesdays 0615 with *English-Chinese* lesson. (Sanderson, Australia)

Tangier—*Radio Sweden* reports that *The Pan-American Radio* has been heard testing on approximately 15.050 at 0700-0730, with announcements in

Spanish and *English*; says is owned and operated by the International Banking Corporation of Tangier.

Thailand—Bangkok currently is using approximately 6.010 (only one heard here in West Virginia; fair), 11.910, and 15.910 for the overseas broadcast in *English* daily 0500-0630; news 0515, 0615. (Sanderson, Australia)

USA—The *Voice of America* has increased its languages to 25; latest added was Vietnamese for Indo-China. (Boillard, Mass.)

Verification was received recently from Coast Guard Station NMY, East Moriches, Long Island, New York, for report of transmission on 2.698.

USI—Kuta Aradja, Sumatra, 8.910, has been heard signing off 0930; weak signal and CWQRM from DUM, Philippines; sometimes plays *English* recordings. (Neeley, Oregon)

Menado, 9.84, Celebes, noted 0705 announcing as "Radio National Indonesia"; excellent signal in Delaware. (Cox) Sanderson, Australia, lists this one currently as on 9.845, heard 0710 with music, then news in Dutch; program for troops. Stark, Texas, notes Makassar, 9.55, Celebes, at 0630.

Djakarta's YDF, 6.045, is like a local some days around 0730-0830 in native language. (Raith, Calif.)

USSR—Current schedules of *Radio Moscow* to North America are 0800-0830, 17.84, 15.18, 11.96, 11.82; 1820-1930, 2000-2300, 15.23, 15.18, 15.11, 11.96, 11.83, 11.71, 9.69. Is also good signal here in West Virginia around 0900-0945 to Southeast Asia, news 0900.

Heard in Georgia on 11.71 with talks in *English* 1430. (Fargo)

Vatican—HVJ, 17.445, is good in Newfoundland on Tuesdays 1030 in *English* for Far East. (Peddle)

Venezuela—YVKR, 4.920, *Radio Caracas*, signs off 2330; no *English* noted. (Callarman, Oregon)

Yugoslavia—*Radio Belgrade*, 9.505, still has news 0045. (Bellington, N. Y.)

* * *

Last Minute Tips

The Arabic-speaker on approximately 6.770 daily 1300-1500 may be ZNR, Aden, returned to the air (?). (Radio Sweden)

A Spanish-speaking station heard on approximately 8.985 with CWQRM after 2200, announces HRXW, may be Honduras (?). (Stark, Texas)

Radio Sweden reports on unidentified station—probably Greek—on approximately 5.940 with news 1500.

At the time this was compiled, I had just received a flash from Schilling, Calif., that he had picked up *Radio Seoul*, Korea, on 7.933 at 2350; signed off 0000 and announced as "the Democratic Peoples Republic of Korea"; woman announcer spoke good *English*; may have been a special broadcast as was not heard on subsequent nights.

Akashvani, Mysore (India), operates on 6.065 (listed 6.026; moved?) at 2030-2200, 0230-0400, 0700-1130; has news relays from AIR, Delhi, at 2130,



FIRST WITH THE FINEST!

TALK-A-PHONE, the world's finest and most complete line of intercommunication, has *everything!* Designed, developed and precision-engineered by the leader in its field, with more than a quarter-century experience in electronics, TALK-A-PHONE meets every requirement.

Known wherever intercommunication is used as the system that "has everything—does everything," TALK-A-PHONE *alone* gives you DYNASONIC intercom; MULTI-MAGIC Selector; UNI-TRANS Dictation Control; HOLD-A-MATIC Conference Control and many other features that are years ahead of ordinary systems.

Now—Another TALK-A-PHONE Exclusive!

The *New* TALK-A-PHONE brings you REDI-POWER intercommunication! Precision-built to furnish a full 10-watts output, the new REDI-POWER Talk-A-Phone has self-compensating power control output that automatically supplies exactly the output needed. Investigate this TALK-A-PHONE *Exclusive!*

Where
Quality
talks—it's

Talk-A-Phone

TALK-A-PHONE COMPANY • CHICAGO 23, ILL.

When Answering Advertisements Please Mention
RADIO & TELEVISION NEWS

LEARN DAY and EVENING CLASSES
TELEVISION
ELECTRONICS-RADIO
Modern Laboratory
Instruction in

- SERVICING
- BROADCAST OPERATING
- ELECTRONIC and TV ENGINEERING

WRITE FOR ILLUSTRATED CATALOG
ELECTRONICS INSTITUTE, Inc.
21 HENRY, DETROIT 1, MICH.

G.I. APPROVED

BARGAINS!

● We still have plenty of them—but, we are doing so much business that we are afraid we won't have anything left to sell in a few months. Most of the material we have been advertising is still available—check with us for current prices.

WANTED!

● Right now we are more interested in buying than selling. We want to buy large or small quantities of new or used electronic components, equipment, tubes, etc., gov't or mfrs. surplus. Cash or trade for standard test equipment or electronic material of your choice.

ELECTRONIC RESEARCH LABS
1021-R Callowhill St. Phila. 23, Pa.

MAKE a 3-way system

from your Dual Speaker,

or a full 2-way Speaker

from your conventional

driver—with the Stephens

HY-SON—Model 107

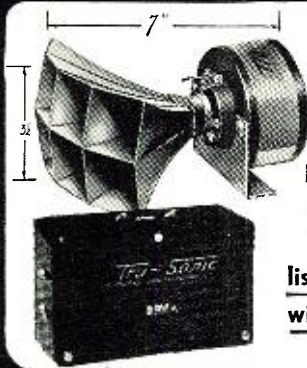

Price
\$50⁰⁰
list, complete
with network

**A super high frequency
reproducer system for the
3500-20,000 cps. range**

The Hy-Son System, in combination with 2-way speaker systems or conventional single voice coil speakers, gives an added clean extension of high frequency reproduction. Due to the small mass of the moving system, together with a carefully designed throat configuration, very low distortion is assured. This unit finds itself a fitting complement to high quality source materials now available, such as tape and wide range disc recordings, FM Broadcasts, and live reproduction installations.

Specifications: Power input above 3500 cps, 20 watts from program material, 5 watts steady tone. Reproducing range 3500-20,000 cps., flat ± 3 db to 15,000 cps. Impedance, 16 ohms. Voice coil diameter 1", motor mass 350 milligrams. Weight, unit and crossover combined, 5½ lbs. Size, driver only, 3½" diameter by 2½" deep, with 2 x 4 40° x 80° high frequency horn attached. 7" deep overall. Hy-Son System Model 107 is sold only with Model 3500X, one-half section high pass filter network, to insure proper operation of driver and attenuation of low frequencies. **Price complete with network, \$50.00, list.**

See your dealer. Write for Bulletin A-1 describing and pricing the complete Stephens Tru-Sonic line.

STEPHENS

MANUFACTURING CORPORATION
TRU SONIC

8538 Warner Dr., Culver City, Calif.

0300, 0730, 1030. (Copenhagen DX broadcast)

When this was written, *Radio Eir-vean*, 17.84, was being heard irregularly with news 1230. (Cox, Delaware) So far the new 100 kw. station had not been reported with "promised" tests.

According to *Radio Sweden*, "*Radio Free Europe*" is located in Western Germany and broadcasts to all countries under Communist control; reported as operating 0700-1300 on 6.135, daily. Programs are prepared in studios in New York City. Several (probably six) additional transmitters are planned. I have been promised further details by officials of *National Committee for a Free Europe, Inc.*, Room 301, 350 Fifth Avenue, N. Y. C.

The Far Eastern Broadcasting Company, Manila, Philippines, has been heard testing over DZH8, 15.300, to 1105 sign-off; fair signal but almost buried at times under BFEBS, Singapore, same channel; DZH8 announces is operating in the international short-wave band on 15.3 by permission of the Radio Control Division of the Philippine Republic. Asks for reports

on quality and signal strength to Station DZH8, Far Eastern Broadcasting Company, Manila, Philippines; reminds listeners of transmissions over DZAF, DZH6, and DZH7; plays mostly religious music with announcements after each song. (Neeley, Oregon) Heard by Balbi, Calif., testing 0000-0100 and other times; best at 0915; has frequent announcements in *English*.

An airmail flash from Orhwall, Sweden, says he has definitely identified the station heard afternoons EST (around 1300-1400) on approximately 6.015 as Salisbury, Southern Rhodesia; improved signal more recently resulted in his reading the announcement, "This is Rhodesia calling from Salisbury."

Radio France Asie ("The Voice of France in the Far East"), Saigon, sent this schedule for *English* broadcasts—1745-1800, first news broadcast; 1930-2000, 15 minutes of music, then second news broadcast; 0415-0515, talk and music, then third news broadcast; 0545-0600, fourth news broadcast; 0900-1015, fifth news broadcast, then music; all sessions are radiated on

FREAK TV RECEPTION PROVIDES INTERESTING VIDEO FARE

ONE of the interesting phenomena encountered by viewers is that of "freak reception." Theoretically, television reception should be limited to locations within "line of sight" of the transmitter, but this has not proven to be the case.

We have received an interesting report of television DX-ing from Burns J. Tobias of Millersburg, Pa., which seems to indicate that distance is no handicap to the video enthusiast.

The TV station nearest to Mr. Tobias' home town is WGAL in Lancaster, some 45 miles away. The terrain around Millersburg is hilly. He uses a Du Mont 19" "Fairfield" Model RA110 receiver, two Regency boosters, and a Taco antenna. The antenna is a three-section unit with the top Yagi array cut for

Channel 4, the middle section (of 4 sets of rods) cut for the high band, while the bottom array is a Yagi cut for Channel 6. The entire unit is rotatable and is mounted 75 feet above the ground.

Mr. Tobias has compiled the accompanying table covering his DX-ing experiences. Needless to say, some of the distant stations provide good reception while others are mediocre but the fact that some of the stations are received at all is somewhat unusual.

He reports that most of the extremely distant stations are only received at night although daytime reception of Miami (4), San Antonio (4), and Oklahoma City (4) are commonplace. Oklahoma City pops up on the screen most often and the reception is usually good.

-50-

Table of TV stations received by Burns J. Tobias of Millersburg, Pa.

STATION	CITY	DISTANCE	CHANNEL NO.	RECEPTION
WGAL	Lancaster	45	4	Good
WMAR	Baltimore	80	2	Fair
WBAL	Baltimore	80	11	Poor
WAAM	Baltimore	80	13	Poor
WJAC	Johnstown	100	13	Poor
WPTZ	Philadelphia	100	3	Fair
WFIL	Philadelphia	100	6	Very Good
WCAU	Philadelphia	100	10	Poor
WNBW	Washington	100	4	Poor
WATV	Newark	150	13	Fair
WDTV	Pittsburgh	164	3	Poor
WCBS	New York	165	2	Fair
WNBT	New York	165	4	Fair
WABD	New York	165	5	Poor
WJZ	New York	165	7	Poor
WOR	New York	165	9	Fair
WPIX	New York	165	11	Fair
WBEN	Buffalo	196	4	Poor
WOI	Ames	882	4	Good (at times)
WDAF	Kansas City	956	4	Fair
KOTV	Tulsa	1059	6	Poor
WTVJ	Miami	1127	4	Good (on occasion)
WKY	Oklahoma City	1157	4	Good (most often received)
KLEE	Houston	1408	2	Good
WOAI	San Antonio	1555	4	Poor

11.83 and the first two (1745-1800, 1930-2000) are transmitted also at 6.165. (Baker, Calif.)

* * *

Press Time Flashes

Current schedules of *Radio Australia*, just received airmail, include 1500-1800 (Sat. to 1815), to British Isles and Europe, VLC, 15.20, VLA8, 11.76; 1529-1800 (Sat. 1559-1815), to Japan, North Pacific Islands, VLB11, 15.16; 1800-1950 (Fri. 1800-2100; Sat. 1815-2100), to S.E. Asia (Malaya), VLC, 15.20; 1815-1950 (Fri. 1815-2100; Sat. 1828-2100), to South and S.E. Asia (India, Pakistan, Malaya), VLA10, 17.84; 1950-2230 (not Fri. or Sat.), to S.E. Asia, and N.W. Australia, VLG11, 15.21; 2145-2315 (Fri. 2100-2145; Sat. 2100-2315), to Japan, North Pacific Islands, VLB5, 21.54; 2145-2315 (Fri. 2100-2315; Sat. 2100-2315), to S.E. Asia (Malaya), VLC, 15.20; 2145-2330 (Fri. and Sat. 2100-2330), to South and S.E. Asia (India, Pakistan, Malaya), VLA10, 17.84; sporting, only Fri. 2145-Sat. 0230, to Japan, North Pacific Islands, VLB5, 21.54; 2330-0045, to South and S.E. Asia, VLA10, 17.84, and to Africa (not Fri.-Sat.), VLB5, 21.54, and to North America (West Coast), VLC, 15.20; 0045-0155, to South and S.E. Asia, VLA10, 17.84; 0100-0140 (in French), to Tahiti, VLG11, 15.21, and to French Indo-China, VLC, 15.20; 0155-0315, to British Isles, Europe, and Southern Asia, VLA10, 17.84, and to British Isles, New Zealand, VLC4, 15.32, and to British Isles, Europe, New Zealand (not Sat.), VLB3, 11.76; 0200-0230 (Fri. only; in Thai), to Thailand, VLG11, 15.21; 0245-0345 (French), to New Caledonia, VLG11, 15.21; 0328-0630, to Japan, North Pacific Islands, VLA6, 15.20; 0328-0450, to N. Asia, Japan, VLB4, 11.85; 0328-0530, to South and S.E. Asia, VLC4, 15.32; 0500-0630, to S.E. Asia, VLB4, 11.85; 0530-0600 (in Indonesian), to Indonesia, VLC4, 15.32; 0600-0630, to South and S.E. Asia, VLC4, 15.32; 0630-0855, to Japan, North Pacific Islands, VLA6, 15.20; 0630-0900, to South and S.E. Asia, VLB4, 11.85; 0700-0900, to North America (East Coast), VLC4, 15.32; 0900-1000, to South and S.E. Asia, VLB4, 11.85; 0900-1000, to British Isles and Europe, VLA6, 15.20; 0900-1000, to North America (Central and Mountain Zones), VLC4, 15.32; 1000-1115, to South and S.E. Asia, VLB4, 11.85, and to North America (West Coast), VLC4, 15.32; 1015-1115, to Africa, VLA4, 11.77. In addition, VLG, 10 kw., is scheduled for use in the Overseas and Inland Short-Wave Services as follows—1500-1930 (Fri. 1500-0045; Sat. 1600-0045), VLG11, 15.21, to New Guinea; 1950-2230 (not Fri. or Sat.), VLG11, 15.21, to S.E. Asia and N.W. Australia; 2245-0045 (not Fri. or Sat.), VLG11, 15.21, to New Guinea; 0100-0140, VLG11, 15.21, to Tahiti (in French); 0200-0230 (Fri. only), VLG11, 15.21, to Thailand (in Thai); 0245-0345, VLG11, 15.21, to New Caledonia (in French); and 0359-0830 (Sat. to 0900), VLG10, 11.76, to New Guinea.

SAVE UP TO 95% SENSATIONAL SURPLUS VALUES!

BC-906 ABSORPTION-TYPE FREQ. METER



Freq. range 150-225 Mc. Uses 0-500 DC Microammeter for indicator. In black crackle carrying case with handle. 12 1/2 x 8 1/4 x 6 3/4". Net 18 lbs. With tubes and calibration chart. **\$14.95**

COMMAND RECEIVERS

Tested Before Shipping
190-550 KC Used. Orig. \$40. Now... **\$12.50**
3-6 MC Used. Orig. \$30. Now... **4.95**
3-6 MC New. Orig. \$35. Now... **6.50**
6-9 MC Used like new... **7.95**
1.5-3 Meg. Brand New... **18.95**
R-28, ARC-5 100-156 Meps. **25.00**



COMMAND XMITTERS

T-22 ARC, 5 MC. Used. SAME as BC-459. **\$ 8.95**
T-22 ARC-5.7-9.1. New. Orig. \$50. Now... **12.75**
3-4 MC. Used. Orig. \$50. Now... **12.50**
T-23/ARC-5100-156 Meps. 4-channel Xtal. Used. **25.00**
T-21 ARC-5.5-3.7. New. Orig. \$40. Now... **5.95**
4-5.3 MC. Used. Orig. \$30. Now... **3.49**
2-1-3 MC. LN. Orig. \$40. Now... **9.95**

GO-9 XMITTER Freq. range 3-18 MC and 300-600 KC. 100w output. Brand New! Complete with tubes and spare part kit. Comes in 3 units, high and low freq. xmitter and rectifier. **\$72.50**
Only a few available.

CITIZENS BAND FREQ. METER

LAVOIE VHF FREQ. METER. Type 1055M. Types from 375-725 MC. 1 1/2 Brand New! Complete **\$49.95**

WESTERN ELECTRIC AUDIO AMPLIFIER TYPE D-150300



An excellent mod. driver or PA system with hi-quality components. Input stage consists of 2-6I7's into 2-6L7's feeding 2-6C5's. Impedance couple to 6L6's in PP parallel. Class A 40 W output 225 ohms output impedance. Power supply 110V 60 cyc. using 2-5T4's. Has Built-in limiter and compression circuits. Maximum gain 110 DB. Fits standard 17" rack. Tube sub-chassis is hinged and folds back for easy servicing in rack as shown. Excell. cond. COMPLETE WITH TUBES AND DIAGRAM. **\$49.95**

EXPORT INQUIRIES FROM FOREIGN COUNTRIES INVITED

We give immediate answers and prompt service. Many items now in stock not listed here. Let us quote prices on your requirements.

IMPORTANT

NO ORDER LESS THAN \$5.00. Send 30% deposit on cost of item or full amount to save COD charges. Do not send shipping costs. It will be COD only. Shipments sent via railway express unless other instructions given. Merchandise subject to prior sale. Prices subject to change at any time.

PEN-OSCIL-LITE

Extremely convenient test oscillator for all radio servicing; alignment • Small as a pen • Self powered • Range from 700 cycles audio to over 600 megacycles u.h.f. • Output from zero to 125 v. • Low in cost • Used by Signal Corps • Write for information.

GENERAL TEST EQUIPMENT
38 Argyle Buffalo 22, N. Y.

RADIO ENGINEERING DEGREE IN 27 MONTHS

Radio engineering is a big field. There's room for you in it—if you're good. Get first-class training at Indiana Tech. Intensive specialized course, including strong basis in mathematics and electrical engineering, advanced radio theory and design, television. Modern laboratory. Low tuition. Also 27-month courses in Aeronautical, Chemical, Civil, Electrical and Mechanical Engineering. Approved for G.I.'s. Enter December, March, June, September. You can earn part of your expenses right here in Fort Wayne while you are studying.

INDIANA TECHNICAL COLLEGE
9100 E. Washington Blvd., Fort Wayne 2, Indiana
Please send me free information on B.S. Engineering Degree in 27 months as checked.

Radio-Television Aeronautical
 Civil Mechanical Electrical

Name
Address

TBY VIBROPACK for TBY Transceiver. Supplies all voltages. **\$12.50**
Operates on 4-volt source. Brand new. Only.....

BC-620 FM TRANSCEIVER and PE 120 VIBROPACK. 20 to 27.9 Megacycles. Xtal Controlled. Part of SCR-509. Includes PE-120 Vibrator Power Supply Battery Case, Shock Mounting, Used, but in excellent condition. **\$22.50**

NEW STANDARD BRAND CHOKES

SWINGING CHOKES

HY	MILS	OHMS	PRICE	VOLTAGE	CASE	WT.
8-40	175	100	2.25	3KV	Closed	3.5
8-30	200	80	2.95	3KV	Closed	4.5
5-25	200	100	2.20	2KV	Closed	5
5-25	300	90	6.95	5KV	Closed	18
8-25	300	80	4.95	5KV	Open	8 1/2
5-25	300	80	3.95	3KV	Open	4
5-25	500	60	9.95	7KV	Closed	28
8-40	1 amp	50	24.95	10KV	Closed	58

SMOOTHING CHOKES

HY	MILS	OHMS	PRICE	VOLTAGE	CASE	WT.
7	150	200	.95	2KV	Open	2
10	500	80	2.95	7KV	Closed	28
12	300	80	5.95	5KV	Closed	8
12	375	105	5.95	5KV	Closed	8
12	400	400	4.95	2KV	Closed	15
15	200	120	2.00	3KV	Open	4.5 lbs.
20	300	80	3.95	3KV	Closed	9 lbs.
20	300	90	4.50	4KV	Closed	10 lbs.
20	400	85	4.95	5KV	Closed	14 lbs.
20	550	60	7.75	6KV	Closed	14 lbs.

SMOOTHING CHOKES WITH HUM BUCKING TAP

HY	MILS	OHMS	PRICE	VOLTAGE	CASE	WT.
20 Series	1A	50	39.50	10K	Closed	80
5 Parallel	1A	12.5				
16 Series	175	96				
4 Parallel	350	24	5.95	2.5K	Closed	15
26 Series	200	112	6.95	3.5K	Closed	15
6.25 Parallel	400	28				

T-85/APT-5 VHF TRANSMITTER. New, 350 to 1200 meg. 5 to 30 watts output. Brand new complete with tubes **\$42.50**

BC-1072 XMITTER

157-187 MC. Input 117 VAC 60 cy. Has parallel rod OSC using 2-826 PP. contains power supply, general radio variac 1.5A. 3/4" 0-5 kilovoltmeter, 10 tubes and loads of other parts too numerous to mention. Complete with tubes. Less blower. Used **\$19.75**



BC-924 FM XMITTER

Frequency range 27.39 Mc. 35 watts output 4 channels, tunable throughout entire range, band width 20 Kc ECO controlled. 2-6S17, 2-6I5, 1-5A67, 1-6V6, 1-VR-150/30, 1-6S17, and 2-815. Complete with tubes, with dynamotor. Used **\$21.95**

CRT-3 EMERGENCY DUAL FREQUENCY LIFE RAFT TRANSMITTER. **\$49.50**
Approved by CAA.

BC-376 MARKER BEACON TEST OSCILLATOR for testing BC-1023 and 1033. Used. **\$59.50**

Just a Few Left!
PORTABLE FM XMITTERS AND RCVRs!

Operate on 6V DC, 34 MC varied either direction depending xtals, xmtr and Rcvr has aluminum case with antenna relay. Xmtr uses 1073, 125 KC extra in osc. stage followed by 4 doublers and 1 fin. amp. all using HY 65 tubes. Mike amp. and Fre. Mod. use 1C7G tubes. Xmtr stages have metering jacks. Rcvr is superhet. Xtal cont. local osc at 8060 KC. Power Supply on chassis using Carter 6v gen. output 450 v. 250 ma 6v vibrator power supply for receiver. All tubes inst. heating. Included is control box, hand set, 8" speaker and extra microphone. Used, complete set only **\$45.00**

SEND 10c FOR NEW 1950 CATALOG

V&H RADIO & ELECTRONICS SUPPLY
DEPT. R-15, 2033-37 W. VENICE BLVD. LOS ANGELES 6, CALIFORNIA

MAGNAFILTER



NOW! The 22" Size!
BETTER VISION
on your 19" screen

Magnafilter offers a new experience in restful tele-viewing. This zero-zero optical lens is easy-on-your-eyes, filters out the glare, gives third dimensional effect and distortion free engagemnt.

Magnafilter is beautifully made of clear, oil filled plastic, and adds to the beauty of the finest television installation. Chrome top bracket or floor stand. Available in 10", 14", 16", 18" and 22" sizes.

For full information and name of your nearest dealer*, write to:

• • • • • **RUSSELL LENS CO.** • • • • •
11056 Cumpston St.
North Hollywood, California

*A few dealer opportunities available.

TRAP INTERFERENCE

Effectively

with DON GOOD TRAPS

TELEPASS*—TELETRAPS* (FM & DIA.)
... TVI TRAPS*

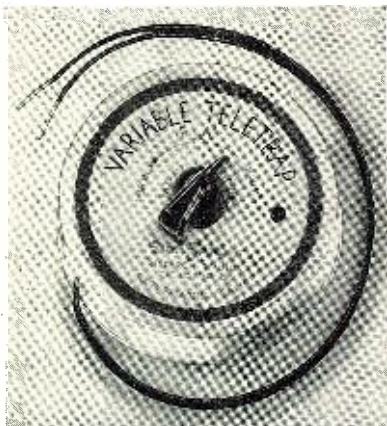

DON GOOD TRAPS, known as "DARN GOOD TRAPS", do their job—they do eliminate unwanted interference. That's why they're so well liked—and used.

POPULARLY PRICED—ALL AT \$3.95 . . . ALL NEW ITEMS.

New DON GOOD TELEPASS* Here's a TV HIGH PASS FILTER that eliminates or greatly reduces interference which may be picked up by I. F. Amplifier or TV Receiver and interference which may arise from strong, local low-frequency fields radiated from Amateur Radio Stations, Diathermy and X-Ray Equipment, Industrial Induction Heaters, Appliances, Neon Signs, etc. . . . Pre-tuned at factory—no adjustments required. Easily installed at receiver antenna terminal. In compact, low-loss Polystyrene case—2 3/8" x 1 1/4" . . . NO. 300—for 300 Ohm Line. . . NO. 72—for 72 Ohm Line.

PRICE—either—\$3.95.

DON GOOD VARIABLE TELETRAPS*

NO. R-301 FM—88 MC to 110 MC. This effectively eliminates interference from F. M. Stations operating within its tuning range.

NO. R-302—DA—26 MC to 32 MC. This effectively eliminates interference from DIATHERMY and AMATEUR SIGNALS within its tuning range. **EITHER TELETRAP* ABOVE—PRICE: \$3.95.** For quick, simple installation at TV receiver antenna terminals.

DON GOOD VARIABLE T.V.I. TRAPS*

NO. T-301 LB—LOW BAND. Reduces or effectively eliminates harmonic interference on TELEVISION CHANNELS—2 through 6—within its tuning range—50 MC to 90 MC.

New T-302 HB—HIGH BAND. Reduces or effectively eliminates harmonic interference on TELEVISION CHANNELS—7 through 13—within its tuning range—170 MC to 220 MC.

Either T.V.I. TRAP* ABOVE—PRICE: \$3.95. . . . For tunable, quick, easy-installation on antenna feedlines of AMATEUR TRANSMITTERS.

DON GOOD ADJACENT CHANNEL TELETRAPS*

These effectively trap adjacent channel signals with respect to any desired channel. **NO. R-103—LB—LOW BAND.** Tunable to trap any single channel—2 through 6. . . . **NO. R-104—HB—HIGH BAND.** Tunable to trap any single channel—7 through 13. . . . Easily installed on TV receiver antenna terminals. **PRICE—\$3.95**

NOTE: All above TELETRAPS* and T.V.I. TRAPS* are tunable and are enclosed in a round, compact, low-loss Polystyrene case: 3 3/8" diameter x 1 1/8" thick.

*PATENT PENDING *TRADE MARK
ASK YOUR LOCAL DEALER OR WRITE

Don Good INC.

ALSO MANUFACTURERS OF
GOODLINE AIRLEAD*

1014 FAIR OAKS AVE., SOUTH PASADENA, CAL.
PHONE: SYcamore 9-1194

The 1950 Edition of *World Radio Handbook* should be available this month or next from Ben E. Wilbur, 32 Whittlesey Ave., East Orange, New Jersey. Is compiled by O.-Lund Johansen, Copenhagen, Denmark, but is entirely in *English*.

Latest schedules of Canada's International Service are—*European Service*—0915-1130, CKNC, CKCX; 1130-1545, CKNC, CKCS; 1545-1600, CKCS; 1600-1830, CKCS, CHOL. *Australian Service*—2050-2320 (except Sat. and Sun), UN commentaries, CKLX, CHOL; 0340-0530 (Sun. only), CHOL, CKLO. *Caribbean & Latin American Service*—1850-2045, CKRA, CKCX; 2045-2100, CKRA; 2100-2235, CKRA, CKLO. Outlets are CKNC, 17.82; CKCS, 15.32; CKCX, 15.19; CKLX, 15.09; CKRA, 11.76; CHOL, 11.72; CKLO, 9.63.

A station heard by Bluman, Israel, on 6.017 at 1200 may be Monrovia, Liberia. (Radio Australia)

PJC2, 5.010, Willemstad, Curacao, has *English* Mondays only at 2000. (Ferguson, N.C.)

A new outlet is TGNA, 6.039, heard at 2205; has announcements in *English* as well as Spanish; relays TGN and usually closes down around 2215; asks for reports to P.O. Box 601, Guatemala City, Guatemala. (Ferguson, N.C., and Callarman, Oregon)

Another new station is HRXW, 8.982, noted 1710; relays HRX announced as 1200 kc., and announces as "Radio Comayagua"; news in Spanish 2200; usually signs off around 2257; good level when clear of QRM. (Ferguson, N.C., and Stark, Texas)

At press time I had just received word direct from Harry Mahool, Deputy Director, Radio Free Europe, 311 Empire State Building, New York 1, N. Y., that *Radio Free Europe* broadcasts daily from its transmitter in the U.S. Zone in Germany (overseas sources say from Frankfurt) at 1200-1800 over 6.130 with 7.5 kw. The wavelength is 48.94 m. It is presumed that the language of the country to which it is beamed is used at present during periods to various countries. Schedule is 1200 music; 1400 to Czechoslovakia; 1420 to Poland; 1440 to Hungary; 1500 to Bulgaria; 1520 to Roumania; 1540 music; 1600 to Czechoslovakia; 1620 to Poland; 1640 to Hungary; 1700 to Bulgaria; 1720 to Roumania; 1740 music; 1800 close-down. *Radio Free Europe* is a division of the *National Committee for a Free Europe, Inc.* I understand its purpose is to get word about the "American way of life" into Iron-Curtain countries.

Pan American Radio, Tangier, has been testing 0700-0730 only on 15.050; various alterations are being made to antennas at this station. (Radio Sweden)

Ankara should soon be using TAP, 9.465, again for its Mailbag Program on Sundays and be back on standard time—that is, at 1630. When this was compiled it was still heard over TAQ, 15.195, at 1530.

Cox, Delaware, flashes that the

SENSATIONAL VALUE!

#630 type

16" CHASSIS

Mfr. Licensed under
R.C.A. Patents

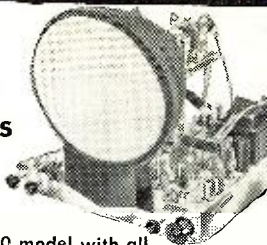

the latest 1950 model with all the newest electronic improvements . . .

- 30 tubes
- synchrolock tuning
- keyed A G C
- 15,000 volts under load
- 12-inch RCA speaker
- phono-jack attachment
- RMA guarantee—Plus our Guarantee

A set—NOT A KIT.

Completely wired, Factory Engineered, aligned and tested.

Complete with 16" first quality tube AND Beautiful hand-rubbed Mahogany Console Cabinet.

COMPLETE PRICE

\$239⁹⁵

With 19" tube slightly higher

1 YEAR GUARANTEE ON TUBE

A half-hour to mount; ready for operation. Saves up to \$150.

Compare this anywhere for high quality—low price!

Write Dept. F for further information. Phone and mail orders filled on receipt of money order for 25% as deposit . . . the balance C.O.D., f.o.b. N. Y.

NEW ENGLAND TELEVISION CORP.

248 E. 149 ST. Bronx 51, N. Y.

NEW MUSIC LOVERS AMPLIFIER

the GROMMES CUSTOM

undisputed best... "Ears" or Instruments!

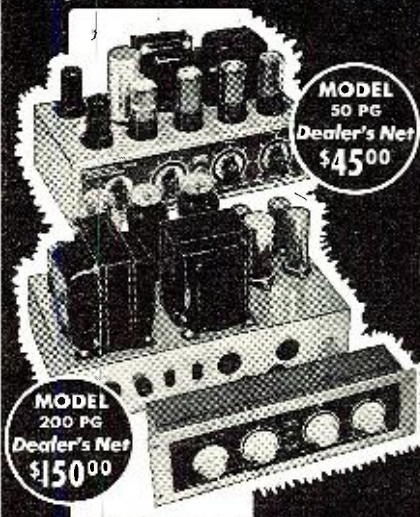

MODEL 50 PG
Dealer's Net
\$4500

MODEL 200 PG
Dealer's Net
\$1500

Exclusive feedback circuits. Model 200PG offers frequency response of 10.1 DB, 10 to 50,000 CPS. Distortion at 20 watts is 0.2%—no phase shift or transient oscillations of any kind. Write today for free technical bulletin.

PRECISION ELECTRONICS, INC.

641-43 MILWAUKEE AVENUE • CHICAGO 22, ILLINOIS

French-speaker signing on 2230 on 9.515 is *definitely* Radio *Tananarive*, Madagascar; he heard "Ici Radio Tananarive" announced for several nights in a row.

Although FK8AA, Noumea, New Caledonia, has been reported moved to approximately 6.010, it was still on measured 6.0346 at 0530 when checked by Oskay, N. J., at the time this was compiled; sign-on is believed 0200.

SRI, Buenos Aires, Argentina, has made a few schedule changes; LRS, 11.88, is now scheduled 0900-2230 (from 0800 Sun.); in Portuguese 0900 (from 0800 Sun.)-1200; German 1200-1300; Italian 1300-1400; English 1400-1500; Swedish 1500-1600; French 1600-1700; German 1800-1830, and Portuguese 1930-2230. LRU, 15.29, is scheduled 1215-1545 and 2100-0100 with English 1215-1330; Spanish 1330-1445, and Italian 1445-1545; the 2100 transmission is still entirely in Spanish. LRY, 9.455, is scheduled 1600-1750 (1600-1700 in Spanish, 1700-1750 in English for Europe), and 2115-0100 in English for North America. (Callarman, Oregon)

Bellington, N. Y., has recently noted FBS, Middle East, Malta, on approximately 6.02 in parallel with 7.22 from 2300 sign-on.

The Wednesday DX sessions from Leopoldville, 9.767, are now at 1410 and 2210. (Copenhagen DX broadcast) * * *

Acknowledgement

Thanks, fellows, for the FB reports during the summer. Now that we're entering the winter DX season, let's have more good reports to 948 Stewartstown Road, Morgantown, West Virginia, USA. KRB.

A new cathode-ray tube tester adapter, designed to be used in conjunction with any Sylvania tube tester, makes possible the checking of almost all of the electromagnetic cathode ray tubes without removal from the receiver. Approximately 85% of cathode-ray troubles may be detected by use of this adapter. Shorts, leakage, open heaters, and relative emission may be checked. The assembly consists of a cable, complete with socket and plug. W. G. "Pat" Patterson here shows the new unit to Harold Rainier, also of Sylvania.



WAR SURPLUS BARGAINS Get 'em now while they're still available!

FREQ. METER BC-438. Easily converted to precision lab. xtal calibrated heterodyne-type freq. meter and sign. gen., 20 to 440 mc. with audio modulation. We furnish simple instructions for conversion and calibration. Has power supply, tubes, and lab. standard xtal. Start where your BC-221 or LM ends. Excellent cond., **\$27.50** complete as described. Write they last.

NAME-BRAND MOBILE FM. 152-162 mc. New, post-war, at amazing close-out prices. 6 v. taxi set only \$125, WALKIE TALKIE only \$79.50. Complete w/handset, antenna etc., Less xtals. Write for descriptions.

DYNAMOTORS
DM-42-A. 12 v. two outputs: 1030 v. 260 ma for PA. plus 515 v. 215 ma. for mod., etc. **NEW** . . . \$9.95
 DY-12. 24 v. two outputs: 1150 v. 350 ma; plus 400 v. 400 ma. **NEW** (less base) \$7.95
PE-73. 24 v. 1000 v 350 ma; with starting relay, filters, etc. **NEW**—\$5.95; **FAIR USED** \$4.95
INVERTER: PE-218. 24 v in. output \$11.50
400 cv. 3500 va. NEW \$17.50

LOOK WHAT \$2.65 WILL BUY!
A 6 V DYNAMOTOR. Very low battery drain. Multiple windings! 250 v DC, 100 ma; to 350 v DC, 70 ma. Windings to add in 10 A increments. No extra work. Or use as a 2:1 or 1:2 Step-up or step-down xformer for DC voltage! Change 6 to 12, or 12 to 24, or vice versa. Handles up to 3 amps. Or use as a GENERATOR. Turn with motor, get 12 v DC at 12.6 A, or 24 v DC at 6.3 A, plus high voltage. Complete dope sheet **\$2.65** furnished. **BRAND NEW**

FL. XFORMER. HV Amertran type V.S.T., 115 v. 60 cv. pri; sec 5 v CT at 10 A insulated for 33 KV test; 12 KV DCWV. Built-on socket for 872A, **\$12.50**
 250T. 371. etc. With new 872A.

RF & AF SIGNAL TRACER BZ-5
 Tiny dual vibrator gives beaut. 1700 CPS tone, harmonics to 40 mc. **NEW**, schem. & instr. **79c**

274N AND ARC-5 TRANSMITTERS
T-19/ARC-5. 3-4 mc. repacks, like new. \$10.95
 Excellent used 8.95
BC-457. 4-3.3 mc. Excellent, used. 4.95
BC-458. 5-3.7 mc. Excellent, used. 5.95
BC-459. 7-9.1 mc. Excellent, used. 9.95
T-22/ARC-5. 7-9.1 mc. repacks, like new. 9.95
MD-7/ARC-5. Push-pull modulator. Excellent. 9.95
MOD BC-456. Brand New 5.95
 Excellent, used 2.49

274N AND ARC-5 RECEIVERS
BC-454. 3 to 6 mc. **NEW** \$6.95. Good used. \$4.95
BC-455. 6 to 9 mc. **NEW** \$12.95. Good used 7.95
 Local Control Adapter parts for 274N or ARC-5 receiver. Exact pot, switch, knobs, etched plate, and instruction data. Ready to mount. \$1.29
 Spine tuning knob. 59c

RCA ceiling speaker, 23" dia., 6 ohm. \$8.95
V C Voltmeter. New, boxed, Weston 476, 0-130 v AC, flush 3 1/2" round. \$3.95
Oil Filled 4 x 8 mtd. 600 v condenser, in one case, common grid, new, with mtg. hooks. \$2.89

EXPERIMENTER'S SPECIAL
 A receiver you can do wonders with! Make intermod. analyzer for testing audio amplifiers, convert to F.I. etc. Has dual bridge instrument rectifiers, also super AVC system. RF is 108.3 to 110.3. Has 3-717A tubes (use as direct replacement for 68K7, with much more gain), 2-125F7, 1-125Q7, 1-12A6, 1-12AH7, 2-12SR7. With schematic, all conversion **\$7.95** done, excellent condition

3-DIGIT resettable Veeder-Root counter with pilot lamp assembly, wafer switch, nice case. **NEW**. **79c**
PU-25 Plug-in tuning unit for BC-229, freq. 3500-3250 kc., includes 80 meters. Ideal low power xmttr. foundation, or a feast for parts. Ant. coupling, ant. inductance, xtal selection switches, coils, condensers. **\$1.29** in. Useful, hinged-top, steel case. **NEW**
 Willard 2 v wet cell battery, new, 20 amp. hrs. 98c

MARINE SPECIALS
G.L. "MARINER" TRANSMITTER. 180 w. input, 120 w to antenna, 300v modulated, 4 ch. xtal. output, 12 or 24 v input (specify volt. & freq. when ordering), w/Dynamotor, connecting cord, xtals, tubes (parallel 814's final, mike, all aligned and ready to operate). Built-in receiver breaks-in relay in addition to ant. switching relay. Dimensions: 8 1/4" deep, 17 1/4" wide, 10 1/2" high. Tubes included: 10X speech amp, two 211 mod., 12-25 12A, two 814 PA. This xmttr. built up from \$1200 gov. cost surplus. W/instructions FCC license approval guaranteed. **\$275.00**

G.L. "MARINER" RECEIVER. Long wave, broadcast, marine and short wave reception. A beautiful conversion of finest Navy surplus! All controls, vernier tuning. Built-in receiver and entirely new front panel. Coaxial type antenna fittings furnished. Tagged wires end to rear to connect to battery, to power DU-1 loop and to kill B+ with xmttr. break-in relay. 12 or 24 v DC. Compact: 13 1/2" long, 8" wide, 6 3/4" high. No plugs needed, ready to go (less speaker). **\$69.50**
 Specify voltage

NAVY TYPE ARA SCR-274N Receiver. 1.5-3 MC. Rewired for 12 v with brand new 12 v dynamotor mtg. 20 lugs. Phone plug built into front, result for front panel control (ON-OFF, Vol., CW-MCW, tuning). With harness and plug for 12 v input and for output to power DU-1 loop. New converted (less spkr.) **\$32.50**
 Same as above, but for 24 v. **\$27.50**

DU-1 Manual Directional Finder. Goes ahead of G.L. "Mariner" ARA, or any other receiver. Converted for Marine hands, still retains half of original use as power DU-1 loop. New converted (less spkr.) 2 tube pre-amplifier. No 180° ambiguity. True bearing in-amp. immediately. New, converted. **\$32.50**

Waterproof Bulkhead Speaker with matching Univ. transformer, cord, plug, very hi-fi. **\$9.95**

Tuning Units for BC-375. Specify freq. coverage desired. Excellent condition. With schematic showing parts description. **\$1.95**

BC-347-C Booster Amplifier, especially useful as mike-input amplifier to boost modulation, excellent as mike or phono preamplifier. Compact, only 3 3/4" x 4 1/2" x 2 1/2", contains dual-triode power tube, 68K8 and two hi-fi output transformers, one for mike to push-pull grids, one for push-pull output. With schematic, requires external power source. Original use was for interphone amplifier. Good used, & special **69c** at only

Citizen's Band Antenna, with director, radiator, reflector, hardware. Two complete sets. **98c**

GADGETEER'S SPECIALS
ZA Test Oscillator (PE-60050). Used to feed 90 and 130 cv. modulation to recr. input. Contains 12 v vibrator (we tried it on 6 v and it works there, too). Has two switching relays giving separate front outputs. In black plastic case with mtg. plate, instructions and schematic. Has switch, capacitors, chokes, pot., octal socket, etc. Brand new, orig. pack. **49c**

Position Transmitter of Mark-18 Gaininglight unit, Eastman-Kodak, brand new. Full of valuable components. Original packing. **49c**

BABY WINCH. Geared motor. Dozens of uses around home, boat, or shack. Just the thing for opening garage doors, gates, etc. Makes excellent beam rotator or barbeque drive. Has two low-speed high-torque outputs, both reversible by electrical switching. One is a sprocket et-notched wheel, the other is a ratchet-coupled cable drum. Both or either are stopped and/or reversed by adjustable limit switch or remote electrical control. 24 v DC universal motor runs perfectly on 8 to 24 v, 60 cv AC. Geared down to nice, easily-controlled low speed. With simple instructions. **\$4.95**
Only

WANTED! Your spare Surplus Equipment and Tubes, Dynamotors, Recrs, Xmttrs, Test Equipment. Send list, stating condition and your rock bottom price.

G. L. ELECTRONICS 905 S. VERMONT AVE. LOS ANGELES 6, CALIF.
 ALL PRICES F.O.B. LOS ANGELES. CALIF. BUYERS ADD SALES TAX

We've Got 'Em—

Jensen **Electro-Voice** **PRESTO** **SELL SOUND SYSTEMS** **ISATC** **UFG**

Top Names in Audio High Fidelity

We stock the brands you ask for—the top performers in amplifiers, changers, speakers, microphones, tape recorders, record blanks, cartridges, and REPLACE-MENT PARTS. Glad to send you literature and prices on items you're interested in.

Write for **FREE "Audio List 18"**

PENN ELECTRONIC PARTS CO.
 5303 FRANKFORD AVE. PHILA. 24, PA.

400ma. CHOKE

- 12 Henry—90 OHM
- High Voltage Insulation
- Hermetically Sealed

\$3.85 each—10 for \$34.00

VERNIER DIAL (From BC-221)
 2 3/4" Dia. 0-100 in 360°. Black with silver marks. Has thumblock. **85c**

VERNIER DRUM (From BC-221)
 0-50 in 180° black with silver marks **85c**

OIL FILLED CONDENSER SPECIALS
 4mfd, 2,000 V.D.C. \$3.85 (smfd, 2,000 V.D.C. \$5.00
 2mfd, 4,000 V.D.C. 2.25 (4mfd, 600 V.D.C. .79

1N34 CRYSTALS 69c

THROAT MIKE (MT 81-A). 2 mikes in leather zipper case with 56" cord & PL 58 Brand New. **49c**

AN CONNECTORS
 Complete Stock of All Numbers AVAILABLE AT BIG DISCOUNTS

HAYDON Timing Motor. 4 R.P.M., 115 volt, 60 cycle. **\$1.79**

FILAMENT TRANSFORMER
 Pri., 115V., 60 Cyc.—Sec., 5 V., 115 Amp. 6000 volt insulation. **\$9.95 each**

SELSYNS 2J1G1—Brand New—400 Cvc. \$1.65

SOUND POWERED Handset—
 Includes 6 ft. cord. **\$17.60 pr.**

Minimum order \$3.00 — All orders FOB, Phila.

RELIANCE Merchandizing Co.
 Telephone Rittenhouse 6-4927
 2221 Arch Street • Philadelphia 3, Pa.

the only services the chapter had to offer were those of consulting and planning in the communications part of local civil defense plans and Chapter President Harry E. Austin, of *RCA-Victor Division*, was authorized to offer such services of the chapter to the San Francisco Disaster Council and the Alameda County Disaster Council.

South Carolina

AFCA's National Executive Secretary George P. Dixon was guest speaker at the South Carolina Chapter's annual meeting at Columbia on August 2nd. Chapter President Fred M. Fister of the *Southern Bell Tel & Tel* presided and introduced the various guests which included Ralph Grist, president of the Atlanta Chapter; William H. Mansfield, AFCA national director and past president of the Atlanta Chapter; Colonel Henry J. Hort, president of the Augusta-Camp Gordon Chapter; and Hugh A. Fleming, past president of the Augusta-Camp Gordon Chapter.

Colonel Dixon's talk on the past, present, and future of the AFCA was well received and resulted in a general discussion of some of the points raised.

New chapter officers were elected as follows: President—John L. H. Young, *Southern Bell Tel & Tel*, Charleston; 1st vice-president—Samuel A. Ferguson, University of South Carolina; 2nd vice-president—Comdr. Julien J. Edgerly, Charleston Naval Shipyard; secretary—Carl E. Newman, *Southern Bell*, Columbia; treasurer—Jack Pickell, *Southern Bell*, Charleston.

Washington

In preparation for chapter activities in the fall, Comdr. Guy M. Neely, chief engineer of the Office of the Director of Naval Communications, was appointed chairman of the membership committee; and Colonel Percy G. Black, vice-president of *Gary Services*, was appointed chairman of the program committee.

-30-

BIG HAMFEST

THE Federation of Long Island Radio Clubs Inc. will hold its 14th Annual Hamfest at Lost Battalion Hall in Elmhurst, Long Island on November 9th at 8 p.m. Admission to the affair is \$1.50 if tickets are bought in advance or \$2.00 at the gate.

The event will feature entertainment, prizes, and technical talks by men prominent in the amateur field.

Tickets may be obtained from any of the clubs in the Federation (Astoria Radio Club, Amateur UHF Club, Grumman Amateur Radio Club, Nassau Radio Club, Sunrise Radio Club, Trylon Radio Club, and Tuboro Radio Club), selected radio stores, and from the secretary, Thomas S. Black, W2-JSV, 8417 124th Street, Richmond Hill 18, Long Island, New York.

Officers of the sponsoring group are Robert Cross, W2FNI, president; John Cuches, W2ESZ, vice-president; William Kunzler, W2AVI, secretary; and Thomas S. Black, W2JSV, secretary.

-30-

COMMAND TRANSMITTERS and RECEIVERS with SCHEMATICS

	USED:	NEW:
BC-453 Receiver—190-550 KC.	\$11.95	
BC-454 Receiver—3 to 6 MC.	5.95	
BC-455 Receiver—6 to 9.1 MC.	6.95	
BC-457 Transmitter—4 to 5.3 MC.	\$ 5.95	\$8.95
BC-458 Transmitter—5.3 to 7 MC.	5.95	8.95
BC-459 Transmitter—7 to 9 MC.	14.95	24.95
BC-496 Transmitter—3 to 4 MC.	14.95	29.50
T-25/ARC-5 Trans.—100 to 150 KC.		29.50

TRANSMITTERS and RECEIVERS:

	USED:	NEW:
BC-1206C Receiver, 200-400 KC.	\$ 5.95	
BC-357 Marker Beacon Receiver.	2.95	
BC-347C Amplifier with Tubes.	\$2.95	
BC-709 Amplifier	3.95	4.95
RA-10 DA Receiver	17.50	
TA-12 Transmitter	29.95	
BC-250 Transmitter, 1 coil set.	4.95	6.95

BC-375 TRANSMITTER

BC-375 Transmitter—100 Watt Voice, CW, MCW covers frequency range 200 KC. to 12 MC. by the use of Plug-in Tuning Units, as listed below. Complete, with Tubes, less Tuning Units. USED: **\$18.95**

TUNING UNITS FOR BC-375 OR BC-191 TRANSMITTERS (Listed Below) USED: **\$3.95 EACH**

TU-5—1500 to 3000 KC.	TU-9 — 7700 to 10000 KC.
TU-6—3000 to 4500 KC.	TU-10 — 10000 to 12500 KC.
TU-7—4500 to 6200 KC.	TU-26 — 200 to 500 KC.
TU-8—6200 to 7700 KC.	BC-306—Antenna Loading

FT-151 Shock Mounting for BC-375-191.....**\$2.00**
 CABLES 4/BC-375-191 w/PT-64, 50, or 61 ea. end.....**\$2.00 EA.**

BC-223 TRANSMITTER

BC-223 Transmitter, 30 Watt Crystal or MO control on four channels, CW, MCW covers frequency range 2000-5200 KC. by the use of plug-in coils. Complete with Tubes, less Tuning Units (Listed Below). Prices: NEW: **\$34.50** USED: **\$23.50**
 BC-223 TUNING UNITS: TU-17—2000-3000 KC.; TU-18—3000-4500 KC.; TU-25—5200-5250 KC. **\$3.50 EACH**

SPARE TUBE KIT in metal box, f/BC-223.....**\$4.95**
 OPERATING MANUAL for BC-223.....**\$2.00**
 PE-125 POWER SUPPLY f/BC-223—12/24 Volt input; output 500 Volt 150 MA.....NEW: **\$9.95**
 SPARE VIBRATOR & TUBE KIT f/BC-223.....**\$4.95**
 SHOCK MOUNTING for PE-125.....**\$1.50**

RT-7/APN-1 Altimeter Transmitter Receiver. 14 Tube set, 418-462 MC. Complete with Tubes & Dyn.USED: **\$12.95**

TRANSFORMERS—110 V. 60 CYCLE PRIMARIES:
 SEC.:
 24 V. 1 amp. **\$1.95** 24 V. 5 amps. **\$1.50**
 36 V. 2.5 amps. **2.95** 24 V. 4 1/2 amps. **3.95**

Address DEPT. RN • Minimum Order \$2.00 • Prices F.O.B., Lima • 25% Deposit on C.O.D. Orders

FAIR RADIO SALES 132 SOUTH MAIN ST. LIMA, OHIO

EASY TO LEARN IN YOUR HOME... ELECTRONICS RADIO and TELEVISION



RADIO-TELEVISION—the tremendous growth has made more jobs than there are trained men! Studios need qualified technicians and broadcast operators, where you meet top performers and actors. **RIGHT NOW** you can get in on the ground floor in Television as a Broadcast engineer or as a TV installation and service man. Start a service shop in your own home!

ELECTRONICS means rich opportunity for thousands of qualified men! Government and industry send expert electronics engineers all over the world to install, service and operate electronics equipment. In America, thousands of job openings call for trained men!

Central's **MASTER COURSE** in Radio-Television-Electronics can prepare you quickly for a bright future in these fast-growing industries. **LEARN AT HOME IN YOUR SPARE TIME** with practical, easy to understand, lessons and nine big home lab kits for fascinating experiments. **FREE PLACEMENT SERVICE** to help you secure a top pay job!

NOW IS THE TIME TO GET INTO THIS NEW, RICH FIELD OF OPPORTUNITY!

CENTRAL RADIO and TELEVISION SCHOOLS, Inc.
 Dept. RTN, 1644 Wyandotte, Kansas City, Mo.

I want complete information on how I can succeed in Radio, Television and Electronics. This does not obligate me in any way.

Name.....
 Address.....Age.....
 City.....Zone.....State.....

WHIP ANTENNA EQUIPMENT MAST BASES—INSULATED:

MP-132—(Illustrated) 1" heavy coil spring, 2" insulator. Overall length: 11 1/2". Weight 2 1/4 lbs. Price.....**\$3.95**
 MP-22—Spring action direction of bracket, 4"x6" mounting. Price.....**\$2.95**

MAST SECTIONS FOR ABOVE BASES:
 Tubular steel, copper coated, painted, 3 foot sections, screw-in type. MS-53 can be used to make any length, with MS-52-51-50-49 for taper.
 Price—any sectionEa. **50c**
 MS-54 or 55. Larger sections than MS-53.....Ea. **75c**
 BAG BG-56 for carrying 3 Mast Sections..... **50c**

METERS:

0-150 Volt 400 Cycle 2 1/2" Round.....	\$2.95
0-5 Amp. AC 3" Rd. 0-100 A. Scale.....	3.95
0-5 Amp. AC 3" Rd. 0-75 A. Scale.....	3.95
0-5 Milliamp DC 2 1/2" Square.....	2.95
0-500 Microamp 2 1/2" Rd. w/0-15 & 0-600 DC Volt Scale.....	3.95

DYNAMOTORS:

INPUT	OUTPUT:	STOCK No.	PRICE
9 V. DC	450 V. 60 MA.	DA1-9450	
@ 6 V. DC	275 V. 50 MA.	w/Blower	\$3.95
12 or 24 V. DC	440 V. 200 MA. &		
	220 V. 100 MA.	D-104	9.95
12 V. DC	600 V. 300 MA.	BD-86	7.95
12 V. DC	330 V. 150 MA.	BD-87	5.95
12 V. DC	375 V. 150 MA.	BD-83	6.95
12 V. DC	1000 V. 300 MA.	BD-77	7.95

PERMANENT MAGNET FIELD DYNAMOTORS:
 12 or 24 V. DC 275 V. 110 MA. USA/0516 **\$3.95**
 12 or 24 V. DC 500 V. 50 MA. USA/0515 **2.95**
 @ V. DC 240 V. 50 MA.

Tell Us Your Dynamotor, Inverter, & Small Motor Needs!

3/4 RPM ANTENNA ROTATOR MOTOR

High torque, reversible motor—operates directly from 110 Volt 60 cycle by use of condenser. Light weight, quiet running, ruggedly built, positive stop, easily mounted. Normally operates from 110 Volt 400 cycle. Complete—with instructions. NEW.....**\$4.95**



10 MFD 400 Volt Cond. **\$1.00**. SPST Momentary Switch, **35c**. DPDT Momentary Switch, **75c**. Resistor, 100 ohm 25 Watt, **50c**. 4 Wire Cable, **5c** per ft.

A-220 MC. CONVERTER FROM THE SURPLUS R-1/ARR-1 RECEIVER

Ideal compact unit for conversion to the 1 1/2 meter band. Uses four 954 Atom tubes. Size: 3 1/2" x 3 1/2" x 10". For complete conversion instructions, see Radio News Jan., 1949. Price.....**\$6.95**

Address DEPT. RN • Minimum Order \$2.00 • Prices F.O.B., Lima • 25% Deposit on C.O.D. Orders

EVERY RADIOMAN

Can Use These

SERVICE HINTS!

Valuable Manual Yours—FREE!

Every page of "How to Simplify Radio Repairs" is packed with on-the-bench, practical ideas. Contains photos, charts, diagrams—no fluff—no vague theory. In plain every-day language it gives you priceless suggestions—new servicing ideas. You'll use and benefit from the experience of experts. Partial list of contents: How to Localize Trouble; How to Service Amplifiers; How to Test for Distortion; How to Test Audio Circuits; How to Test Speakers; How to Find Faults in Oscillators; How to Test Radio Parts—and it's all yours—FREE! No obligation.



SEND COUPON OR PENNY POSTCARD FOR YOUR FREE COPY TODAY!

FEILER ENGINEERING CO., Dept. 11H5
 1601 S. Federal St., Chicago 16, Illinois
 Please Rush my FREE copy of "How to Simplify Radio Repairs."
 Name.....
 Address.....
 City.....Zone.....State.....

QUAM FOCALIZER UNIT

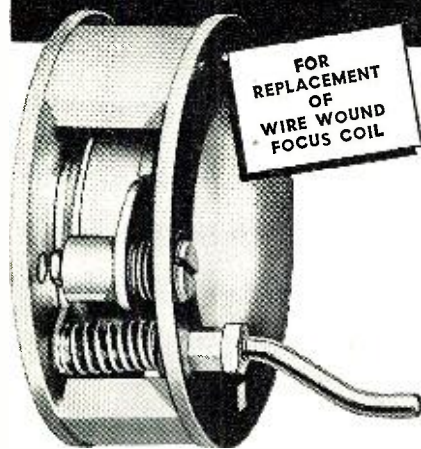

**PROVIDE SHARPER FOCUS
OF TELEVISION IMAGE!**

**UNAFFECTED BY TEMPERATURE
AND VOLTAGE FLUCTUATIONS!**

Simple to Install

NO WIRING NEEDED

Now, wire wound focusing coils are easily replaced on television sets being repaired or rebuilt for larger tubes with the QUAM Alnico V Permanent Magnet Focalizer* unit that is being used as original equipment in many leading sets.

Easy to install, the Quam Focalizer* unit provides a sharper image that is unaffected by voltage and temperature fluctuations.

A slight turn of the adjusting screw brings the tube in focus—the centering handle centers the image on the screen. It is designed for tubes with anode voltages up to 12 K.V.

Aluminum supporting bracket is furnished with kit.

List Price—\$4.75. There's a real demand among service men for these Focalizer* Kits!

ASK YOUR JOBBER ABOUT
the QUAM FOCALIZER* UNIT KIT

*TRADE MARK
QUAM-NICHOLS COMPANY
522 E. 33rd Place Chicago 16, Ill.
Makers of Quam Adjust-A-Cone Speakers.

**CODE SENDING
RECEIVING SPEED**

Free Book

HIGH SPEED

WITHOUT NERVOUS TENSION

REVEALING BOOK shows how "crack" operators develop high speed and proficiency. Learn code for Amateur or Commercial Radiotelegraph License, or improve your sending and receiving with the Candler System which develops radiotelegraph experts and code champions.

CANDLER SYSTEM Box 928, Dept. 2, N.I., Denver, Colorado

Sound on Wheels

(Continued from page 78)

gram material will tend to mask out the desired signal as it arrives at the listener's position. Reducing the affected range and boosting the unaffected bands (using the amplifier treble and bass controls) sometimes assists in reducing the "apparent" distortion or interference of the noise.

Loudspeaker Stand

The stand mechanism itself is quite interesting. It is constructed almost entirely of 1" angle irons and 1" pipe, with all sections welded. The principle is simple. The shaft which mounts the loudspeakers runs through the center of the stand. As the four legs are spread, the sleeve pipes apply pressure to the shaft, thus holding it secure. The shaft, being itself of considerable length, can be adjusted to any convenient height or direction by merely setting it to the desired position before spreading the stand legs full out. The weight of the loudspeakers, instead of being a burden, in this case serves to tighten up the stand. The legs are 3/4" pipe, cut to any desired length and slipped into the sleeve pipes.

Amplifiers

Three amplifiers are aboard the "Studio." One is a 60 watt *Rauland* W-861 which is the main unit used. It is mounted in a *Bud* metal cabinet together with a 30 watt *Rauland* W-835-A which serves as both an alternate and a standby unit. These amplifiers operate from 115 volts a.c. only, and are located directly to the right of the operator, as illustrated in Fig. 9. A third 30 watt amplifier is located just above the power plant and 12 volt inverter. It is a dual voltage unit capable of operating from either 115 volts a.c. or directly off 6 volts d.c. (see Fig. 2). Four mike and two phono inputs (all high impedances) are provided by each amplifier, as well as a three position microphone remote control receptacle. The usual complement of tone, mike, and volume controls are provided and are available to the operator at the front panels.

Changeover Switch

Of particular interest is the amplifier changeover switch. Fig. 11 illustrates the cabinet containing the main and standby amplifiers, with the handle-operated instantaneous changeover switch mounted on one side of the cabinet. All the input and output connections of both amplifiers are run to a 12-gang, cam-operated, single-circuit, double-throw *G-E* switch assembly (CR1070-E105) which, at the flip of the handle, throws either one of the amplifiers into the operating circuit.

So that warm-up delay may be eliminated, the ground return lead of the amplifier power transformer's high voltage winding center tap is brought

"HAVE YOU HEARD
THE SOUND OF QUALITY?"



NEWCOMB SOUND IS BETTER

Manufacturers of public address, mobile, phonograph, musical instrument and wired music amplifiers • Portable systems • Portable phonographs and radios • Transcription players • Rack and panel equipment.

Write today! Circle items of interest and indicate whether you are a Dealer, Parts Jobber or Sound Specialist.

NEWCOMB AUDIO PRODUCTS CO.
DEPT. F, 6824 LEXINGTON AVE.
HOLLYWOOD 38, CALIFORNIA

ATTENTION ALL ELECTRONIC- TELEVISION ENGINEERS

For more than 6 years RADIO-ELECTRONIC ENGINEERING, a special edition of RADIO & TELEVISION NEWS, has kept alert engineers dependably and thoroughly informed on all that's really important in electronic engineering. Selected and exclusive articles and other specialized features of practical and lasting value to electronic engineers are added to the content of the regular edition of RADIO & TELEVISION NEWS.

Subscribers to the regular edition may change to the RADIO-ELECTRONIC ENGINEERING edition by remitting an extra dollar for each 6 months of the unfulfilled portion of their subscriptions.

New subscribers please use the lower half of order card in this issue.

The RADIO-ELECTRONIC ENGINEERING edition is available only by subscription.

RADIO-ELECTRONIC

edition of
RADIO & TELEVISION NEWS
185 N. Wabash Ave.
Chicago 1, Ill.

RADIO & TELEVISION NEWS

out from each amplifier to a section of the switch. The filaments of the standby unit remain lit, and the amplifier goes immediately into action as its high voltage ("B—") is returned to "ground."

Jones plugs and receptacles are used to connect program equipment to the switch. The binding posts feed the amplifier output to the loudspeaker load. Note in Fig. 9 that the turntables and recorders are located atop the engine housing and that the amplifier cabinet is directly alongside. The outside microphone and speaker connections feed from the roof-top connectors to the overhead glove compartment and down to the switch panel. The tuner output is also routed through the glove compartment which serves quite well as a storage place for program input cables arriving from various points of the truck.

Tuner

The tuner is a *Meissner* Dual Band 10-1151, flush mounted on the right side of the cab back wall. A monitor speaker is provided for tuning and monitoring. If announcements are being made from the cab, earphones are used in place of the speaker. Normally, the tuner output, when used, is channeled to one of the "phono" inputs of the p.a. amplifier. However, it is also possible to use the tuner independently of the p.a. system to record a special program off the air onto one of the wire recorders for playback through the p.a. system later on.

To present a suitable impedance to the high impedance input of the recorder, the tuner signal was tapped just ahead of the coupling condenser between the 6H6 2nd detector and 6F8G 1st audio and fed through a .002 μ fd. blocking condenser to an outlet improvised on the tuner chassis. The return circuit is grounded. The level at this point was found to be more than enough for the amplifier. A 12' extendable whip antenna is used. It may be seen in Fig. 12 mounted on the base of the roof-top platform.

Recorders

Two *Webster-Chicago* one-hour capacity wire recorders are used. Here again it was necessary to improvise a bit to feed the proper level and impedance from the amplifier to the high impedance recorder inputs, in order to record the program going out through the p.a. system. The signal being developed across the 250,000 ohm grid leak resistor of the 3rd audio 6SC7 of the amplifiers was found satisfactory, and was brought out to a receptacle at the rear of the amplifier chassis. The recorder inputs are paralleled so that if the program being recorded exceeds one hour, it may be immediately picked up by the second unit. Where a recording is especially important, both units may be used simultaneously as a safeguard against possible trouble with one of the recorders. Normal procedure has been to use the playback system of one of the recorders

BUILD 5 RADIOS ONLY \$14.75

- Absolutely No Knowledge of Radio Necessary
- No Additional Parts Needed
- Excellent Background for Television

The PROGRESSIVE RADIO EDU-KIT will help you, if you want an EDUCATIONAL AND INTERESTING HOBBY, or if you want to get into a WELL-PAYING BUSINESS, or if you want to INCREASE YOUR KNOWLEDGE OF RADIO.

Absolutely no knowledge of radio is necessary. The PROGRESSIVE RADIO EDU-KIT is the product of many years of teaching and engineering experience. The detailed instructions and quizzes are clearly written and illustrated, so that they can be understood by anyone between the ages of 12 and 80.

The PROGRESSIVE RADIO EDU-KIT is not merely a collection of radio parts accompanied by a radio diagram. IT IS PRACTICALLY A RADIO COURSE, offered at a mere fraction of its real value. You will be taught to build radios in a progressive manner. First, you will build a very simple 1-tube receiver. The next set is a little more advanced. Gradually you will find yourself constructing elaborate radio sets, and doing work like a professional radio technician. Every part is illustrated. EVERY STEP INVOLVED IN BUILDING THESE SETS HAS BEEN CAREFULLY PLANNED. YOU CANNOT MAKE A MISTAKE.

Each of the 15 radios you will build operates on 110-120 volts, AC or DC. These sets have been designed to teach you the PRINCIPLES OF RADIO. Therefore, you will build a variety of circuits. The PROGRESSIVE RADIO EDU-KIT is EXCELLENT FOR LEARNING THE PRINCIPLES OF RECEIVER, TRANSMITTER, AND AMPLIFIER DESIGN. It is used in many Radio Schools and Colleges in U.S.A. and abroad. It is used by the Veterans Administration for veteran training.

Quizzes are provided as part of the PROGRESSIVE RADIO EDU-KIT. They will be corrected by our staff at no extra cost.

FREE
1950 EXTRAS:

ELECTRICAL AND RADIO TESTER
SCREWDRIVER
BOOK ON TELEVISION
GENEROUS HANK OF WIRE

ELECTRIC SOLDERING IRON
ALIGNMENT TOOL
SPOOL OF ROSIN CORE SOLDER
MEMBERSHIP IN RADIO-TV CLUB

ORDER YOUR PROGRESSIVE EDU-KIT TODAY, OR SEND FOR FREE "KIT-KATALOG"
POSTAGE PREPAID ON CASH ORDERS. C.O.D. ORDERS ACCEPTED IN U.S.A.

PROGRESSIVE ELECTRONICS CO.

497 Union Ave., Dept. RN-11
Brooklyn 11, New York



CUT HOLES 1/2" to 3 1/2" IN RADIO CHASSIS

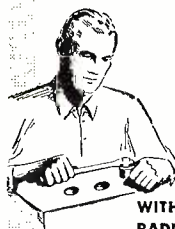

WITH A GREENLEE
RADIO CHASSIS PUNCH

• Save hours of work . . . no reaming or tedious filing. Punch cuts through chassis quickly . . . makes accurate, clean holes for sockets, plugs, and other receptacles. Just turn with an ordinary wrench. There's a GREENLEE Punch in each of these sizes: 1/2"; 3/8"; 3/4"; 7/8"; 1"; 1 1/8"; 1 1/4"; 1 1/2"; 1 3/4"; 1 7/8"; 2 1/4". Write for complete facts. Also get information on Knockout Punches and Cutters for conduit and meter holes up to 3 1/2". Greenlee Tool Co. 1891 Columbia Avenue, Rockford, Illinois.



LEARN

Television - Radio - Electricity

OR

Electricity

IN THE GREAT SHOPS OF COYNE



TRAIN QUICKLY!

OLDEST, BEST EQUIPPED
SCHOOL OF ITS KIND IN U.S.
2 Opportunity Fields

Come to the Great Shops of COYNE in Chicago. Our 51st Year! Get quick, practical training in TELEVISION-RADIO or ELECTRICITY. G.I. Approved. Finance plan for non-veterans. Mail Coupon Today for complete details.

NOT "HOME-STUDY" COURSES!
You learn on real, full-size equipment, not by mail. Finest staff of trained instructors to help you get ready quickly for a better job, a fine future.

FREE BOOKS Clip coupon for big illustrated Coyne book on either TELEVISION-RADIO or ELECTRICITY. Both books sent FREE if you wish. No obligation; no salesman will call. Act NOW!

B. W. COOKE, Pres.
COYNE Electrical & Television-Radio School,
500 S. Paulina St., Chicago 12, Ill. Dept. 80-75H

Send FREE BOOK and full details on:

TELEVISION-RADIO ELECTRICITY

NAME.....

ADDRESS.....

CITY..... STATE.....

WHEN YOU WANT 'EM RED ARROW'S GOT 'EM!

No shortages here—RED ARROW has what it advertises. If you don't see what you want listed, please write. We specialize in Ceramics, Resistors and Condensers. (Manufacturers: ask for our quantity prices.)

TUBE RIOT!

All Branded. New in original carton.

6U7	\$0.37	371	\$0.49
82634	80124
872	1.29	10Y29
24G29	7CP1	2.75

SOLDERING PASTE

— 3 oz. cans — U.S.N. Specification

51-FLB.	29c ea.	(10 for \$2.50)
---------	-------	---------	-----------------

SPECIAL! 10MFD @ 250 V. FP type Condenser
19c ea. (\$15 per hundred)

SINGLE SECTION TRIMMER—2½ to 20 MMF
5c ea. (\$4.50 per hundred)

CONDENSER SALE!

.02 800V Tubular Condenser	10 for 97c	(\$7.25 per hundred)
.0002 600V Tubular Condenser	10 for 92c	(\$7.00 per hundred)
.25 200V Molded Paper Condenser	4c each	(\$3.50 per hundred)
PL 55 PLUGS	29c each	
PL 54 PLUGS	13c each	
CD 307A CORDS	59c each	

3 GANG TRF VARIABLE CONDENSER

365 per section with push buttons.....89c ea.
(10 for \$7.25)

AUTOMOBILE SPEAKERS—4 ohm Field

6"	\$1.50	7"	\$1.75
8"	\$2.00			

HEAVY DUTY LINE CORD with rubber plugs, 3 ft. long, U.L. Approved.....9c each

6 ft. LINE CORD—Molded Rubber Plugs—sold in quantities of 100 only.....\$11.50 per hundred

FILTER UNIT

This unit is an excellent buy for the parts alone. Some parts are worth more than we're asking for the whole unit. Here's what you get:

1—40 MFD @ 450V	2—20 watt Resistors
1—1600 MFD @ 12V	2—Filter Chokes
1—.5 MFD @ 400V	3—RF Chokes
2—.5 MFD @ 50V	1—DPST Toggle Switch
1—.01 MFD @ 400V	Miscellaneous hardware, wire, etc.
BRAND NEW, ORIGINAL PACKING89c ea.
	(10 for \$7.50)

SLEEVING—various colors and sizes—3 ft. lengths.
10 lengths for 25c
100 lengths for \$2.00

HS 33 HEADPHONES

Used, Excellent Condition.....98c pair

SPECIAL!

300 ohm Twin Lead TV Line, 100 ft.	\$2.39
4 Conductor Flat Wire, used for Rotor	
Antennas	5c per ft.
3 Conductor Flat Wire	4c per ft.
5 Conductor Flat Wire	7c per ft.
Kit of 25 Assorted Knobs	59c

MINIMUM ORDER—\$2.00. Send 25% deposit with order. balance C.O.D. Shipped F.O.B., N.Y.C. (N.Y.C. residents add 2% sales tax.)

RED ARROW SALES

Dept. A, 63 East Broadway, N. Y. 2
Phone—Cortland 7-5425

When answering Ads please mention
RADIO & TELEVISION NEWS

RADIO and TELEVISION

Over 30 years N.E. Radio Training Center. Train for all types FCC operators' licenses. Also Radio and Television servicing. FM-AM broadcasting transmitters at school. Send for Catalog M.

MASS. RADIO SCHOOL

271 Huntington Avenue Boston 15, Massachusetts
Lic. by Comm. Mass. Dept. Educ.

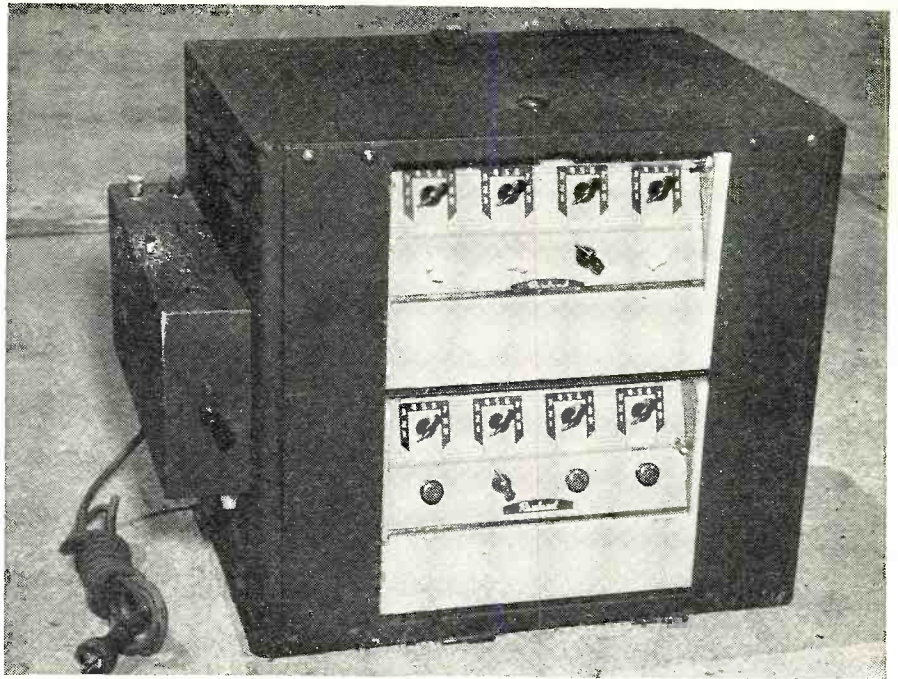

Fig. 11. Cabinet housing main and standby amplifiers. A handle-operated instantaneous changeover switch is mounted on one side of the cabinet, as shown in photo.

to monitor the output of the p.a. system, while the other unit is prepared and ready to record should some unusual occurrence dictate its immediate use.

For playback, the high impedance outputs of the recorders are fed to either one of the "phono" inputs to the amplifier.

Turntables

Two turntables are available. One is a *Garrard* 78 r.p.m. intermix, the other a 78 r.p.m. manual. Both units have adjustable speed controls, a very handy gadget with which to cope with varying voltage or frequency problems. Although 45 and 33½ r.p.m.

equipment could be used, the lightweight pickups which are required will usually be found impractical for use in a moving or vibrating truck. Where lengthy periods of music are called for, the automatic changer and wire recorders have sufficed.

Quite often, only certain passages of a record are to be played. Chalk marks serve as effective starting cues. Stopping the program instantly in a vibrating truck, without resorting to changing volume control settings, is accomplished quite simply by incorporating a pickup shorting switch (push-button type) on the turntable base. Output cuts off instantly at precisely the desired point, allowing the

Fig. 12. Closeup view of top of sound truck with announcer's stand partially collapsed.



* VOLOMETERS

MODEL 102

(1000 ohms per volt meter)

- 3" SQUARE METER
- 3 AC CURRENT RANGES (0-30/150/600 ma.)
- Same zero adjustment for both resistance ranges (0-1000 ohms, 0-1 megohms)

5 DC & 5 AC Voltage Ranges to 3,000 Volts. Also 4 DC Current Ranges. **\$1390**



MODEL 104

(20,000 ohms per volt meter)

- 4 1/2" SQUARE METER (50 micro-amperes — alnico magnet)
- Includes carrying strap
- 5 DC Voltage Ranges at 20,000 ohms/volt to 3,000 V.; 5 AC Voltage Ranges to 3,000 V., 3 Resistance Ranges to 20 megs. Also 3 A C & D C Current Ranges & 5 DB Ranges.

\$2495

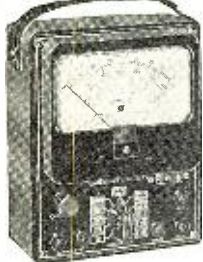

All of the above have round cornered, bakelite, molded cases. (*Reg. Trade Mark for Volt-Ohm-Milliammeter)

Export Dept., 303 W. 42nd St., N.Y.C.
Write Dept. A-11 for Free Catalog

Gives More Measurement Value Per Dollar



ELECTRONIC MEASUREMENTS CORPORATION

423 Broome Street, New York 13, N.Y.

SAVE with SWEDGAL'S LOWER PRICES!



PORTABLE AMPLIFIER CASE

Case: 3/4" plywood construction. Cut out for 12" speaker.
Dimensions: 16 3/4" long x 1 1/2" deep x 2 1/4" high.
Covering: Two-tone black and cream leatherette (slightly soiled).
Hardware: Large non-rattling carrying handle, 4 metal dome feet.

ADDED FREE: \$7.95
Thank-you chassis Comp that fits perfectly! plate

Front View



Back View

SPEAKERS ALNICO V

Lower Prices!	Ea.	Asst.
3 1/2" P.M.	.58 oz.	\$.95 \$.89
4" P.M.	.68 oz.	.95 .89
4" P.M.	1 oz.	1.05 .99
4" P.M.	1.47 oz.	1.10 1.04
4"x6" P.M.	1 oz.	1.59 1.49
5" P.M.	.68 oz.	.92 .89
5" P.M.	1 oz.	.98 .93
5" P.M.	1.47 oz.	1.10 1.04
6" P.M.	1 oz.	1.40 1.32
6" P.M.	1.47 oz.	1.50 1.42
10" P.M.	6.8 oz.	3.69 3.59
12" P.M.	4.64 oz.	4.75 4.50

OUTPUT TRANSFORMERS

45 P.P.	43 P.P.	25A6 P.P.	6L6 ... ca. 66c
1S4 P.P.	59c	6V6 P.P.	50L6 ... 44c
3S4 P.P.		6V6 P.P.	25L6 P.P. } 49c
3V4 P.P.		6V6 P.P.	50L6 P.P. } ca.

IF TRANSFORMERS

Precision Wound Radio Coils, Medium Size 456 KC. Input or Output... ca. 35c
Midget Iron Core, 456 KC. Input or Output... ca. 48c

6V6 15 Watts

Sec. Taps 4, 8, 15, 250 and 500 ohms.
Fully Shielded... ca. **\$1.49**

Electrolytic Tubular Condensers

Fresh stock! With mounting strap, CD Type BDL.
20x20-150V 250,000
40x40-150V 350,000
50x30-150V 500,000
1 meg. or 2 megs. **39c ea.**

AUTO-TRANSFORMER

117 V. AC
Can also be hooked up to deliver secondary V. -70 V., 4.5 V. (Open circuit ratings) **\$1.49**

POWER TRANSFORMERS:

560V. CT @ 50 ma. filament voltage 5V @ 2 amps **\$1.55**
ISOLATION TRANSFORMER with 6V heater winding, 115V. primary, 250V. @ 60 ma., 6.3 V. **\$1.79**

SWEDGAL RADIO, INC.

96 Warren St., Dept. N-8, New York 7, N. Y.
Portland 7-6753

pickup to be removed from the record at will.

Actually, a third turntable is available. It is part of the dual voltage 30-watt emergency amplifier and may be operated in place of the 115 volt a.c. units just described, in case of a.c. power failure.

Microphones

Various type microphones are available for both close-talking and omnidirectional applications. A high impedance crystal microphone is used for cab announcements, all other hand and floor types being low impedance units. The inputs to the amplifiers are actually high impedance, but *Amperite* LGP low-to-high impedance line transformers precede the first three input channels so that low impedance mikes may be used. Thus, whether the microphones are situated next to or atop the truck, or several hundred feet away, the low impedance lines will assure low loss.

Fig. 10 is a view of the rear of the truck showing reels containing microphone cable. Reels on the right side of the truck hold loudspeaker and power line cables. Also in view is the three-position microphone remote control, which may be operated as far away as 2000 feet. This is especially convenient for shows, pageants, concerts, etc., where volume levels must be changed on cue or with varying conditions. The extension cables on each reel end in male and female *Amphenol* connectors (polarity strictly observed) so that lines may be series connected to form long lines.

Two *Amphenol* feedthrough connectors are installed on the roof-top for external connection to the microphones. One of these may be seen in Fig. 9, at the extreme left. The center outlet shown is the a.c. power output from the power plant and the one on the right is a.c. input used when commercial power is brought in.

Field Telephone

A battery-operated field telephone (see Fig. 2) is a useful adjunct to any sound truck to direct set-up operations. With an observer stationed at the far reaches of the area to be observed, loudspeaker direction and "throw" can be adjusted, as well as amplifier volume and tone control settings. For shows, reviews, concerts, it may also be used for cueing purposes.

Collapsible Platform

Fig. 12 is a view of the roof-top, with the announcer's stand half collapsed. When not in use, the entire stand lies flat upon the roof, and the two ladder side railings and vertical posts are detached and laid into position atop the stand floorboard. The ladder itself is swung up and then pushed forward on rollers under the stand floor. With such clever arrangement, headroom required while traveling is substantially reduced. It may be set up by one person in about two minutes.

GOLDEN WAND

INDOOR Television ANTENNA

SALES ARE CLIMBING

BECAUSE THEY'RE BETTER MADE

Check THESE 5 EXCLUSIVE FEATURES POINT BY POINT!

1. Phosphor bronze shims at all telescoping joints for better electrical contact. Constant tension; jamless telescopic action.
2. Admiralty brass dipoles for better electrical conductivity. Stronger; will not rust or corrode.
3. Polystyrene base for better insulation. Terminals completely housed to prevent lead breakage.
4. Terminals completely housed. No strain on terminals, hence breakage of wires impossible.
5. Polystyrene insulators for better insulation.

TWO POPULAR MODELS
Full Channel Coverage—TV plus FM

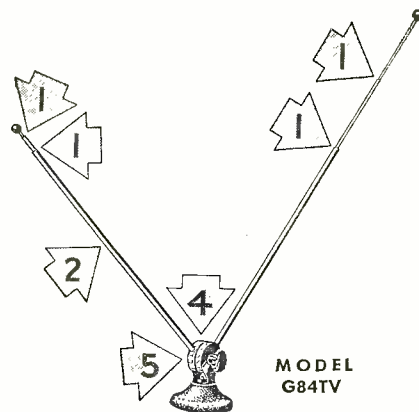

MODEL G84TV—3-section polished finish dipoles. Adjustable friction holds dipoles at any angle. Heavily weighted, felt padded base, gold finished. Harmonizes with any room or set. Supplied with 300-ohm lead-in.

LIST PRICE \$6.95

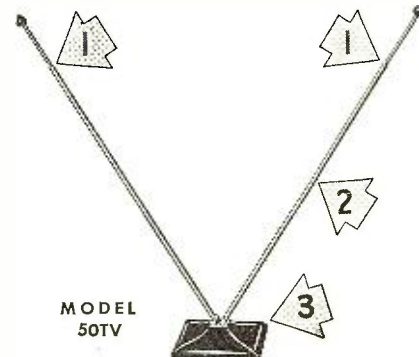

MODEL 50TV—2-section satin finish dipoles. Automatic friction holds dipoles at any angle. Walnut-mahogany polystyrene base, felt padded, heavily weighted. Will not tip when fully extended. Slot in base for mounting on wall, window frame or ceiling. Harmonizes with any set or furnishings.

LIST PRICE \$6.95

Order from your Radio Dealer

PEERLESS PRODUCTS INDUSTRIES
814 North Peleski Road, Chicago 51, Illinois

TELEVISION ANTENNA KIT

\$9.95
Complete

8 Bar conical antenna, 100 feet of twin lead 8 foot aluminum mast—8 standoffs—high and low frequency conical scientifically engineered to give maximum performance. Very high gain. Easy installation.



Less accessories
\$5.95

Double Stack with aluminum accessories, complete **\$15.95**

SKY TUNER \$24.95



You simply press a button on the remote-control cabinet and the antenna rotates right or left, as you desire, until the picture is brightest. You release, and reception is automatically locked in that precise position! Banishes "ghosts" and man-made interference, and enables you to adjust reception with extreme accuracy to the daily variations in signal direction due to changing atmospheric conditions.

- Fingertip control stops antenna instantly.
- Operates on 25 volts from any 110 volt AC wall outlet.
- Will take any antenna installation. Shipped ready to install, with instructions.
- Self-protecting feature prevents accidental damage due to improper operation.
- 370 degree rotation in either direction.
- Scientific speed of rotation aids quick selection of peak reception—one revolution every 45 seconds.
- Permanently weather-sealed in cast aluminum housing designed for rigidity, durability.
- Withstands antenna weight of 150 lbs. Shipping wt. 8 lbs.
- Three-wire control simple to install, more economical.
- No dead spots.



IMPROVED, ALL-ALUMINUM

TELESCOPING ANTENNA MAST

\$16.95
18 ft.
\$26.95
35 ft.

Engineered for Television and FM—Increases Signal Strength—Reduced Interference—Improves Reception in Remote Areas—Ideal for "Hams." Raised in an upright position from 6 feet to 35 feet simply and easily due to STEP-TUBE design. All necessary parts such as screw eyes, bolts, double galvanized guy wires (360 ft.) cut to length.

-SPECIALS-

Chimney Mounts extra quality \$1.59
Coaxial cable, ft.06
Shielded 300 OHM Line, ft.12

20% deposit with order required. Balance—on arrival collect. Orders under \$5.00 send check or Money Order PLUS postage.

RICHFRED Television Sales Co.
Box 100—11 Hill St., Newark, N. J., R.N. 1

Read
RADIO & TELEVISION NEWS Every Month

TELEVISION

PREPARE FOR A GOOD JOB!
BROADCAST ENGINEER
COMMERCIAL OPERATOR (CODE)
RADIO SERVICEMAN

Television Servicing

(Approved for Veterans)
SEND FOR FREE LITERATURE
BALTIMORE TECHNICAL INSTITUTE
1425 EUTAW PLACE, BALT. 17, MD.

Manufacturers' Literature

Readers are asked to write directly to the manufacturer for the literature. By mentioning **RADIO & TELEVISION NEWS**, the issue and page, and enclosing the proper amount, when indicated, delay will be prevented.

TV ANTENNAS

One of the most comprehensive TV antenna and accessory catalogues ever issued is currently available from *The JFD Manufacturing Co., Inc.* of 6101 Sixteenth Avenue, Brooklyn 4, New York.

This 12-page booklet lists hundreds of television antenna installation items ranging from all types of antennas to brackets, parts, test leads, alignment tools, and standoffs.

Copies of this booklet may be obtained from the manufacturer, its representatives, or distributors.

FUSE COUNTER CARD

Littelfuse of 4757 N. Ravenswood Avenue, Chicago 40, Illinois, has introduced a "Snap-On TV Fuse Holder" counter card as a sales aid to service technicians, dealers, and distributors.

The card, done in a color scheme of green and white with black lettering, has 24 fuse holders along with a clear and self-explanatory picture which shows how to use the holder for replacing pigtail fuses.

The display is designed to be used either on the counter or hung on the wall. Full details on the new card are available from the company.

DISPLAY FIXTURES

Emerson Radio & Phonograph Corporation of 111 8th Avenue, New York 11, N. Y., has recently brought out a new line of "Silent Salesman" displays to aid dealers in merchandising the company's radios and phono-radios.

The Merchandiser SS-6 consists of a series of shelves to display and demonstrate nine radios and phono-radios while the matching Merchandiser SS-7 is designed with platform and shelves to accommodate three television receivers. Both displays utilize an expanded gold-colored metal grille in diamond pattern over green sprayed masonite for the center panel. Hardwoods, finished in Swedish blonde, are used for the frame of the center panel and the supports. The curved side panels and the shelves are painted a lighter tone of green.

Details on these new display fixtures may be secured from the company's distributors.

RECORDING EQUIPMENT

Rek-O-Kut Company, Inc. of 38-01 Queens Blvd., Long Island City 1, New York, has just issued a new catalogue covering its line of recording and transcription equipment.

Listed and illustrated are portable three-speed phonographs, three-speed

record players, dual-speed 16" recording turntables, 16" overhead recording mechanisms, dual-speed 12" recording turntables, transcription turntables, accessories for these units, professional disc recorders, and universal recording amplifiers.

Complete specifications are given on each of the products listed, along with prices and catalogue numbers. Persons actively engaged in work involving the recording and reproduction of sound will find this catalogue a handy reference guide.

AUDIO COMPONENTS

Audak Company, 500 Fifth Avenue, New York 18, New York, has announced the availability of a new catalogue covering its polyphase reproducers, tuned-ribbon units, tone-arms, pickups, cutters, and equalizers.

Performance details, catalogue numbers, and prices are given on the various units in the company's line. Response graphs are provided on the tuned-ribbon and the polyphase units.

A copy of this handy 4-page publication is available on request.

BAKELITE BOOKLET

The *Bakelite Division* of *Union Carbide and Carbon Corporation* has recently published a comprehensive booklet summarizing the characteristics, development, and latest applications of the company's polyethylene resins.

This 24-page booklet gives a brief history of the product and then outlines some of the many uses for polyethylene. Characteristic properties of the substance, a listing of the available forms, and methods of fabricating are also included in the publication.

Copies of this booklet are available from the company at 300 Madison Ave., New York 17, New York.

RADIO SHACK CATALOGUE

Radio Shack Corporation of 167 Washington St., Boston 8, Massachusetts, has just released its 1951 catalogue of electronic parts, complete equipment, and kits.

Available free on written request, the new 172-page catalogue includes listings on test and service instruments, p.a. and high-fidelity music systems, amateur radio equipment, tubes, transformers, connectors, wire and cable, condensers, resistors, batteries, and books.

PHONO NEEDLE CHART

Jensen Industries, Inc. of 329 South Wood Street, Chicago 12, Illinois, has

RADIO & TELEVISION NEWS

announced the publication of a new edition of its replacement needle wall chart.

The chart (No. J-24) contains all pertinent information on 89 needles, with actual size silhouette illustrations, and includes every needle on the market today.

Copies of this chart, suitable for hanging on the shop wall, are available without charge from the company's jobbers or from the company direct.

CUSTOM CABINETS

Grand Rapids Woodcraft Corporation of 1400 Front, N.W., Grand Rapids 4, Michigan, has issued a folder covering its "Uni-Mode" custom line of radio, television, recorder, and speaker cabinets.

The booklet describes and illustrates a wide variety of cabinet and base units which can be mixed and matched in an almost infinite number of combinations. All of these units are available in a wide range of woods and finishes. A specification sheet provides complete dimensional and constructional data on the line.

Copies of this publication are available to persons interested in the custom installation of all types of radio and television equipment.

ONAN EXPORT PRODUCTS

D. W. Onan & Sons Inc., Minneapolis 14, Minnesota, has prepared a 12-page, two-color booklet covering its entire line of products which are available to the export market.

Included in the folder is a list of suggestions for negotiating export documents. These suggestions are the result of the company's years of experience in the export market and are designed to assist overseas importers in the preparation of such documents necessary in the import-export trade.

The booklet includes electric generating plants, air-cooled, 4-cycle engines and separate ball bearing generators, water-cooled marine generating plants. A special section of the pamphlet describes the company's electric plant accessories such as rubber-tired two-wheel dollies, automatic controls, line transfer controls, gas-gasoline carburetors, heat exchangers, etc.

Copies of this booklet may be secured from the company at the above address. Ask for Export Folder A-185-C.

PROCUREMENT GUIDE

Trilane Associates, Inc., of 1 Hudson Street, New York 13, New York, is presently offering a copy of its publication "United States Government Procurement" free of charge to manufacturers.

Designed as an aid in obtaining government business, this new 16-page brochure covers all aspects of the procurement picture. The booklet is divided into a number of sections, each dealing with a different aspect of procurement. An introductory section

Whether you're in the Armed Services or in Industry

ELECTRONICS TRAINING PAYS OFF

with interesting jobs and higher earnings

CREI Residence School Training offers
Quick promotion in uniform—as well as profitable civilian careers!



In or out of the armed services, the best jobs go to the men with technical training. If you are prepared with electronics training, you're fortified for the future, whether you're headed for a berth in the armed services or a career in essential industry. Because of the critical shortages that exist today in the electronics industry, the qualified technicians and engineers can practically choose their own futures. Because of the dependence of modern armies, navies, and air forces upon electronics—for radar, communications, and navigation—the man with even limited knowledge of electronics gets ahead quickly in uniform. In case you're called to active duty before completion of your CREI course, you'll still be way ahead, for the armed services will choose you for further electronics training in place of the completely untrained man.

At CREI you work with the latest equipment—over 120,000 square feet of modern class

rooms, TV and radio broadcasting studios, transmitters, control rooms, and experimental labs. Here you're grounded in the fundamentals required for work in guided missiles, TV, and all the other important fields of communications and electronics. CREI's experience in training thousands of men for the Army, Navy and Coast Guard in World War II, coupled with pioneering background in technical education and close industry connections, assure you of the best in technical preparation. To insure your training act right now. Send today for free Residence School catalog.

New classes start twice a month.

APPROVED FOR VETERANS

High level home study training also available for professional radio men.

FOR FREE CATALOG, MAIL COUPON NOW!

CAPITOL RADIO ENGINEERING INSTITUTE

16th Street and Park Road N. W.,
Dept. 1311B, Washington 10, D. C.

Please send free Residence School Catalog. (1311B)

Name.....

Street.....

City.....Zone.....State.....

Veteran Non-Veteran Age.....

Send details about Home Study Courses.

— in New England it's ... DE MAMBRO

FOR Hi-Fi EXCLUSIVE DISTRIBUTORS

- ★ McINTOSH Amplifiers
- ★ MAGNECORD Magnetic Tape Recorder
- ★ ELECTRO-VOICE Broadcast Microphones & Loudspeakers
- ★ STROMBERG-CARLSON Amplifiers & Speakers
- ★ ELECTRO-STATIC Loudspeakers
- ★ DAVEN Attenuators

BRANCH OFFICES

90 Broadway, PROVIDENCE, R. I.
222 Summer St., WORCESTER, MASS.
1308 Elm St., MANCHESTER, N. H.

WORLD'S FINEST SELECTION

- ★ ALTEC LANSING Microphones and Loudspeakers
- ★ JIM LANSING Reproducers
- ★ JENSEN Speakers and Enclosures
- ★ H. H. SCOTT Noise Suppressors
- ★ BROWNING Tuners
- ★ WEBSTER Chicago Automatic Record Changers
- ★ CRAFTSMAN—BROOK—MEISSNER—ETC.
- ★ SCOTCH Recording Tapes
- ★ PRESTO & AUDIODISC Recording Blanks
- ★ EICOR—AMPRO

DE MAMBRO RADIO SUPPLY CO., INC.

MAIN OFFICE AND STORE

1111 COMMONWEALTH AVE., BOSTON, MASS. ST., 2-7870

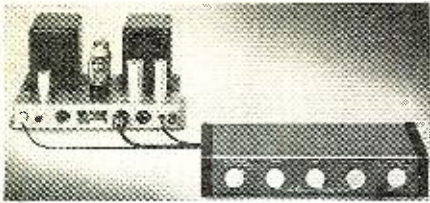

Model A-20-5 and S-20

HIGH QUALITY 20 WATT AMPLIFIERS

0.1% Distortion at 10 watts.*

- Unexcelled crisp, clean reproduction
- Unprecedented flexibility

No other amplifier will so conveniently handle all of today's program sources.

Model S-20.....\$119.50
Model *A-20-5.....\$148.50

LOOK INSIDE!

Before buying Audio Equipment, compare layout, wiring, and quality of components.

Clean wiring means good workmanship
THAT'S YOUR TEST OF QUALITY!

MINIATURE AUDIO OSCILLATOR

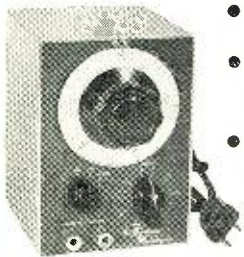

- Wide Range
- Small Size
4" x 5 1/2" x 4"
- Low Distortion
- Constant Output

MODEL 510-A

Range: 18 cycles to 210 kc., output constant within ± 0.5 db.

Output: 10 volts, calibrated

Distortion: Less than 0.3%

Weight: 3 1/2 lbs.

NET PRICE.....\$90



The Electronic
Workshop Inc.

351 Bleeker St. New York 14, N. Y.

WAR SURPLUS

VERTICAL
GYRO UNIT
Originally
Cost \$2855.00
NOW ONLY

\$14.95

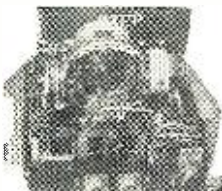

Aluminum housing • One 400-cycle, 115-v., 3-ph. Motor Propelled Gyro • Two 24-v. DC. shunt-wound motors • 2 Electronic Relays • Auto Transformer • Hundreds of precision parts • 35 lbs.

You pay shipping costs. Send check or money order to

SURPLEX RETAIL SALES INC.
2409 S. LaSalle St. Chicago 16, Ill.

explains the various methods of procurement and advises bidders on how to obtain information relative to products or services they have to offer. Another section deals with common errors in bidding that often prove harmful to manufacturers in their relations with the government.

PARTS FLYER

Radio Surplus Corp. of 732 S. Sherman St., Chicago 5, Illinois, is currently distributing an 8-page flyer which lists all types of radio components.

Included in the listing are oil-filled condensers, electrolytics, knobs, audio and filter chokes, connectors, sockets, rheostats, relays, terminal strips, transformers, switches, speakers, r.f. chokes, and various mica condensers.

Copies of this publication are available from the company.

CLOCK MOVEMENTS

Of interest to design engineers is the new electric clock movement catalogue recently published by *The Sessions Clock Co.* of Forestville, Conn.

The new catalogue contains complete information, including detailed scale drawings, of the full line of *Sessions* clock movements. The publication is designed to serve as a buying and engineering guide for all users of clock timing movements.

The products listed feature compactness of design and ease of installation. A unique demountable motor feature allows quick assembly and easy disassembly for adjustment without the aid of tools and without disturbing the rest of the mechanism.

Copies of the catalogue are available without charge by writing to Dept. 16 of the company.

MASCO SOUND EQUIPMENT

A new line of economy sound equipment is covered in the recently-published Catalogue No. E-351 released by *Mark Simpson Mfg. Co., Inc.* of 32-28 49th Street, Long Island City 3, New York.

Included in the catalogue are individual amplifiers and complete sound systems ranging from 8 watts to 52 watts for fixed, portable, and mobile installations.

Listed in the catalogue are 8, 18, 27, 36, and 52 watt units, portable carrying cases, and speaker cabinets for various sound installations. A copy of this bulletin, which is of particular interest to sound men and p.a. technicians, is available on request.

SOLDERING GUN DATA

New soldering information which is of particular interest to TV and radio technicians has been included in the new soldering gun catalogue recently issued by *Weller Electric Corp.* of Easton, Pa.

The new catalogue covers the company's complete line of guns for every type of soldering operation. Detailed descriptions are provided on the various models along with list prices and illustrative material.

STAR SPECIAL!

DELUXE 6-TUBE AUTO RADIO

Includes Speaker
and Antenna

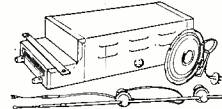

First time ever offered at our bargain low price. Popular make, compactly

built 6-tube radio with matching Alnico 5 PM speaker and big 66" side cowl antenna. Radio measures 13" deep, 4 1/2" high, 6" wide. Complete with all six tubes (6SA7, 2-6SK7, 6SQ7, 6K6GT, 6X5GT rectifier). A super-powerful auto radio that will pull in distant stations without fading! Quick, easy installation under dash of any car. Complete outfit at one low price!
Shipping weight 16 lbs.....\$27.50

COMPLETE STOCKS

All Standard Brands

Just off the press

BIG BARGAIN BULLETIN

STAR

ELECTRONIC
DISTRIBUTORS, INC.

Dept. RN 2-7736 S. Halsted, Chicago 20, Ill.

R. & T. BARGAINS

TRANSFORMER, filament, 115v 60cy; seeds.
5v 25amp or 10v 12.5amp. for 304TL. New. \$ 5.49
INTERCOM & RADIO combination. 550-1500
kc. w/One station. New. 14.95
Detroit BEACON RECEIVER 200-400 kc. 5
tube; used. 3.00
SERVO UNITS with 3/4hp 24v DC motor, part
of M-1 automatic pilot. Orig. case, new. 5.95
CIRCUIT BREAKERS, Heineman, 5 & 30
amp. 110v. Like new. .49
TUNING UNITS for BC-375E. TU9 and 10
less outside can. New. 1.89
HOOKUP WIRE No. 21 copper strand, double
cloth covered, spooled misc. lengths 1000 to
2000 feet. Per 1000 feet. 1.49
CATHODE RAY TUBE 50P7, original package
CO-AXIAL CABLE, RG5U, new, 35, 50, 65
foot lengths. Per foot. .042
APN-4 RECEIVER, good used condition, w/
tubes. 8.95
TRANSMITTER, 1072A, new, 11 tubes, 115v
60 cy w/blower, variac, power supply. Pos-
sible 2 meter receiver. 25.00
CONTROL UNIT 1073A for 1072A. No tubes.
w/wave meter, 115v AC, used good condition
BOTH 1073A and BC-129S SUITABLE
FOR BUILDING LOW VOLTAGE
POWER SUPPLY.
INTERCONNECTORS BC-129S for 1072A. 115v
AC, used good condition. 7.50
TRANSMITTER BC-604 (10 meter) some tubes.
As is. 4.95
F.O.B. Berwyn, Md. Cash with order. Orders without
postage will be shipped express collect. No exports.

R. & T. ELECTRONICS CO., INC.

9723 Baltimore Blvd.

Berwyn, Maryland

Phone: TOWER 5384

When answering advertisements

please mention

RADIO & TELEVISION NEWS

AVAILABLE FOR THE FIRST TIME

ELEMENTS of SINGLE and

DUAL TRACK TAPE RECORDING

and 1001 APPLICATIONS

by A.C. Shoney

A completely new 112 page booklet for recording technicians, experimenters and recordists. Over 100 illustrations, circuit diagrams, parts lists and construction hints. Latest elementary and advanced theory and design. Order your copy today.

Only
\$1.00
postpaid

To: Amplifier Corp. of America
398-92 Broadway, N. Y. C.

- Rush.....copies of A. C. Shoney's Book "Elements" I enclose herewith \$..... @ \$1 per copy.
 Rush free literature on your complete tape recorder line.

NAME.....

ADDRESS.....

CITY.....

STATE.....

AMPLIFIER CORP. of AMERICA
398-92 Broadway, New York 13, N. Y.

RADIO & TELEVISION NEWS

Square Wave Testing

(Continued from page 83)

tions are changed from stage-to-stage until the distorting stage is found.

Square waves can be produced by any audio generator and some form of wave clipping or limiting circuit.

The simplest type uses two crystal diodes to clip the peaks from the positive and negative portions of sine waves. Fig. 2 shows such a clipper. The resulting waves are not true square waves but are flat topped and will serve nearly as well for audio tests. Suitable switching can be ar-

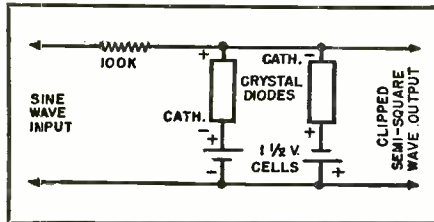

Fig. 2. Simple crystal diode wave clipper.

ranged to shut off the clipping action of either diode thus allowing either peak to be clipped and observed.

A vacuum tube squaring circuit is shown in Fig. 3. This circuit will provide excellent square waves for all frequencies between 20 cycles and 10,000 cycles. It should be added to the audio generator inside the cabinet with the switch arranged to connect or remove it from the circuit. The necessary operating voltages can be obtained from the audio generator.

No attempt will be made in this article to cover the interpretation of square waves as this has been covered previously (see "Wide Frequency Range Square-Wave Clipper," by Louis E. Garner, Jr., in the March, 1950, RADIO & TELEVISION NEWS). The square wave will, in addition to indicating frequency response, indicate phase shift, parasitic oscillation, and transient response quickly. Rather than studying published traces and trying to duplicate them, the user is urged to set up the simple tests given in this article and observe for himself the resulting indications.

Fig. 3. A sine wave squaring circuit.

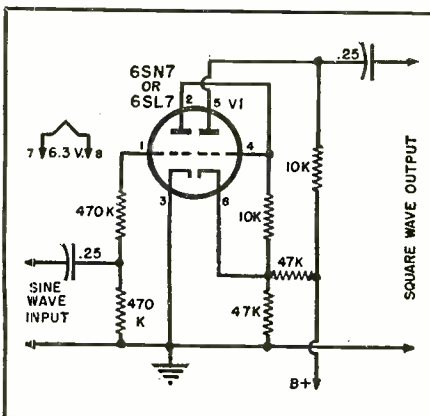

SYNCHRO-SWEEP*

A NEW INVENTION!

PROVIDES

Saw Tooth and Sync Pulses for

- SYNC
- SWEEP
- HIGH VOLTAGE CIRCUITS

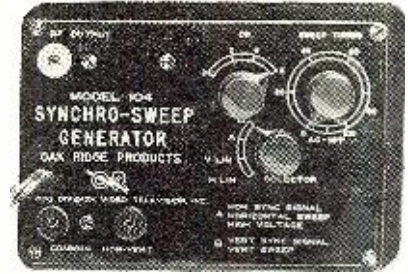

OAK RIDGE "Miniature" Model 104 In Bakelite Case 5 3/4 x 4 x 2 1/4"

TELEVISION SERVICING "ON-THE-SPOT"

With or Without Test Pattern, 'Scope, or Bench Equipment!

Synchro-Sweep* is the FIRST and to date the ONLY TV Test Instrument to provide its own sync and sweep signals for fast trouble-shooting of synch, sweep and high voltage circuits. It supplies:

1. Direct or Transmitted Vertical and Horizontal sync pulses.
2. Vertical and Horizontal Saw Tooth Signals.
3. Transmitted Vertical and Horizontal Linearity Pattern Bars (Cross Hatch). This marvelously compact new precision instrument is acclaimed by leading Servicing Organizations, Parts Jobbers, Technical Schools, as a much needed invention for ON-THE-SPOT Television Servicing!

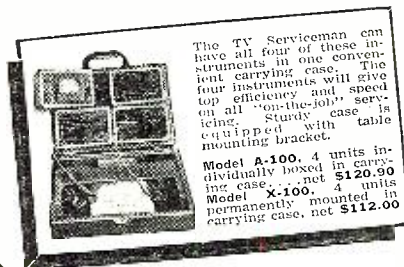

The TV Serviceman can have all four of these instruments in one convenient carrying case. The four instruments will give you efficiency and speed on all "on-the-job" servicing. Sturdy case is equipped with table mounting bracket.

Model A-100, 4 units individually boxed in carrying case, net \$120.90
 Model X-100, 4 units permanently mounted in carrying case, net \$112.00

FOUR OAK RIDGE "MINIATURES"

Model 104 "Synchro-Sweep" (described above)Dealers' Net \$44.50
 Model 101 Substitution Tester.....Dealers' Net 17.95
 Model 103 Signal Generator.....Dealers' Net 33.50
 Model 102 High Voltage Meter.....Dealers' Net 17.95
 See these amazing instruments at your jobber's or write for complete information to:

OAK RIDGE PRODUCTS

(Mfg. Div. of Video Television, Inc.)

37-01 N. Vernon Blvd., Long Island City 1, N. Y.

*T. M. Reg. App. For Pat. App. For



HENRY HAS THE NEW hallicrafters MODEL SX-71 NOW!



This new type of receiver—the first of its kind on the market—has extra sensitivity, selectivity, and definitely superior image rejection. Continuous AM reception from 538 kc to 35 Mc, and 46 to 56 Mc. One RF, 2 conversion, and 3 IF stages. 105-125 volts AC. 11 tubes plus voltage regulator and rectifier. Only \$189.50. (R-46 matching speaker only \$19.95)

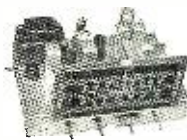

NEW HALLICRAFTERS FM-AM CHASSIS

MODEL S-78 is a precision-engineered FM-AM chassis with these top performance features: Automatic Frequency Control; Full Range Tone Control; Frequency Range 54-1700 kc, 88-108 Mc; Audio Response 50 to 14,000 cycles; 8 watt push-pull output; 105-125 volts 50/60 cycle AC; 10 tubes plus rectifier; phono input jack on rear. In brown plastic escutcheon with matching knobs. Size: 12 1/2" wide, 7 3/8" high, 11" deep. Antenna, FM or AM loop, tuner indicator extra. Medium Priced at \$79.95.

I have a complete stock of Hallicrafters receivers and transmitters. I'll make you the best deal on a trade-in for your communications receiver. I give you prompt delivery, and 90-day FREE service. Nobody can beat Bob Henry on a trade-in, and I offer you the world's lowest credit terms. Write, wire, phone, or visit either store today for the best deal. Export orders solicited.

Bob Henry
 WOPARA

Butler 2, Missouri

HENRY RADIO STORES

11740 Olympic Blvd.
 LOS ANGELES 25
 CALIF.

"WORLD'S LARGEST DISTRIBUTORS OF SHORT WAVE RECEIVERS"

SOUNDTRONICS SPECIALS

SARKES TARZIAN
13 Channel T.V. Tuner

Same type used by leading Mfrs.—West., Magnovox, Teleking, Meck, etc. Ideal for schools, mfrs., etc. Uses 6C4 Osc., 6AG5 Mixer, 6BH6 R.F. Amp.

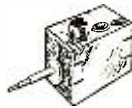

Guaranteed
Less tubes & shields, w/diagram. **\$3.95**

3 TUBE KIT FOR TUNER

6C4, 6AG5, 6BH6..... **\$2.88**

14 PIN TV SOCKETS for 3BP1, 7JP4, etc.

Black Bakelite..... **15c** Mico Filled..... **28c**

F. P. ELECTROLYTIC SPECIAL

10-10-10-20 MFD 450-450-450-25 Volts
49c each **2 for 90c**

TOP BRAND TUBULAR CONDENSERS

.1 MFD 1000 Working Volts..... **9c**
.05 MFD 400 V..... **7c** .25 MFD 400 V..... **7c**
.035 MFD 600 V..... **6c** .035 MFD 1000 V..... **8c**

AEROGLAS #22 1250 V INSUL. WIRE

White with tracer
100'..... **99c** 1000'..... **\$7.98**

MUTER CERAMIC CONDENSERS, 600 V.

15, 22, 33, 56, 75, 82, 180, 220 MMFD.
5c each **\$4.50** per C

U.T.C. CHOKES P.A. CASES

10 HY @ 66 MA.. **\$.97** 10 HY @ 110 MA.. **\$1.40**
5 HY @ 150 MA.. **1.85** 10 HY @ 150 MA.. **2.25**

SPECIAL ASSORTMENTS

50 new pop. type coded res. 50 } Your choice
small pop. ceramic cond., all voltages } **\$1.49** each
& cap. 50 postage stamp mica cond. }

6 V. 12 Amp Fil. TRANS. 115 V. @ 60 Imp. Open frame,
2 1/2" x 3" x 3 1/2"..... **\$1.65**

FALL SPECIAL

New Army Mine Detector AN/PRS-1. Will detect metallic & non-metallic objects, buried cables, etc. Uses 3—45 V. & 1—6 V. bat. Complete, w/spare rods, tubes, etc. Less Batteries..... **\$19.95**

SELENIUM RECTIFIERS

Single Phase full wave bridge. Input 0-18 V., output 0-14 V.
2.4 AMPS..... **\$3.07**
6.4 AMPS..... **4.09**
13 AMPS..... **7.67**
17.5 AMPS..... **8.69**

Min. Order, \$5.00—25% w/order required

SOUNDTRONICS LABS.

632 Arch St., Phila. 6, Pa. MA 7-2775

ELECTRONICS TECHNICIANS WANTED

The RCA Service Company, Inc., a Radio Corporation of America subsidiary, needs qualified electronics technicians for U. S. and overseas assignments. Candidates must be of good character and qualified in the installation or maintenance of RADAR or COMMUNICATIONS equipment or TELEVISION receivers. No age limits, but must have at least three years of practical experience.

RCA Service Company offers comprehensive Company-paid hospitalization, accident and life insurance programs; paid vacations and holidays; periodic review for salary increases; and opportunity to obtain permanent position in our national and international service organization, engaged in the installation and maintenance of AM, FM and TV transmitters, electronic inspection devices, electron microscopes, theatre and home television, r-f heating equipment, mobile and microwave communications systems, and similar electronic equipment.

Base pay, overseas bonus, payments for actual living and other expenses, and benefits mentioned above add up to \$7,000 per year to start for overseas assignments, with periodic review of base salary thereafter. Openings also available at proportionately higher salaries for specially qualified technicians with supervisory ability.

Qualified technicians seeking an advantageous connection with a well-established company, having a broad-based, permanent peacetime and wartime service program, write to:

MR. G. H. METZ,

Personnel Manager,

RCA SERVICE COMPANY, INC.,

CAMDEN 2, NEW JERSEY

Classified

Rate 35c per word. Minimum 10 words

RADIO ENGINEERING

RADIO Engineering Broadcasting, Aviation and Police Radio, Servicing, Marine Operating and Electronics taught thoroughly. Expenses low. Write for catalog. Valparaiso Technical Institute, Dept. N, Valparaiso, Ind.

PANELS for electronic, nucleonic construction projects. Complete service for designers, custom builders. Circular upon request. Gilpin Instrument Works, P. O. Box No. 8, Mt. Clemens, Mich.

SALE

53 OHM Coax, 100 feet \$3.00. Harry H. Van Dick, Box 236, Little Falls, N. J.

TUBES TV-Types, standard makes. Electronicraft, Box 21, Canal St. Station, New York 13, N. Y.

SELL: BC-654, TCS-12, RA-34 Rectifier, I-222-A Signal Generator. T. Howard, 46 Mt. Vernon St., Boston, Mass.

BC221 Army Technical Manuals. 162 pages, for all models. \$2.00. F. Dunan, 1717 Lang Place, N.E., Washington 2, D. C.

CLOCK Radios, \$13. Other bargains see June classified. Catalog. Smith, 46 Fisher Ave., Roxbury, Mass.

FIVE Element TV Yagi Beams. High band \$6.75, Low Band \$8.50. Aluminum Tubing, etc. Willard Radcliff, Fostoria, Ohio.

BARGAINS. New and reconditioned Hallicrafters, National, Collins, Hammarlund, RME, Meissner, other receivers, tuners, television receivers, transmitters, amplifiers, speakers, etc. Lowest wholesale prices! Terms. Shipped on trial. Liberal trade-in allowances. Write Henry Radio, Butler, Mo., and 11240 W. Olympic, Los Angeles, Calif.

HOTTEST surplus list in the country. Electronics-Hydraulics, Aircraft-Gadgets. Dick Rose, Everett, Wash.

RADIO Diagrams 50c; Record Changers, Record-ers 60c; Television Diagrams with service data \$1.00 up. State Manufacturer and model number. Kramer's Radio Service, Dept. RX, 36 Columbus Ave., New York 23, N. Y.

COLOSSAL bargain in radio parts, over 150 assorted radio parts including resistors, condensers, controls, coils, etc. All new, \$75.00 value, guaranteed satisfaction or money refunded, postpaid in U. S. A., \$2.50. Write for catalog. Buyers Syndicate, 30 N. Taylor St., Springfield 3, Mass.

HEARING Aids, Zeniths, Western Electrics. Reconditioned. Make miniature transmitters or receivers. Complete with ear piece and cords, \$16.00 each. Gloria Davis, 2135 Caton Ave., Brooklyn, N. Y.

RECORD Changer Parts for leading makes. We ship everywhere. Friend's Wholesale Distributors, 106 N. 6th St., Philadelphia 6, Pa.

\$3.98 POSTPAID, new Sears recording wire. Hour length only. F. J. Peticolas, Simsbury, Conn.

RADIO. Electric Appliances, Reconciling. Sales, service Motorola dealer. M. F. Sweeney, 462 W. 7th, Winona, Minn.

WANTED

SNIPERSCOPE & Snooperscopes wanted. Any type, any condition. Needed immediately. Box 495, % Radio & Television News, 185 N. Wabash Ave., Chicago 1, Ill.

WANTED. Complete 16" Telev. Chassis, ready for cabinets. On approval only. Box 201, Culver City, Calif.

WANTED: Test Equipment, RA-34, Rectifier. Arrow Appliance, 525 Union St., Lynn, Mass.

WANTED: APR-4 receiver and tuning units. State condition and price. W2DB, 274 Boulevard, Scarsdale, N. Y.

AN/APR-4, APR-5A, APR-1 Receivers and Tuning Units; ARC-1, ARC-3, R-89B/ARN-5A, TS-174/U, other "TS-" equipment; ARR-5, ARR-7, RBL-3, RC-348, ART-13. Radar and other surplus; General Radio, Ferris, Boonton equipment. Describe, price in first letter. Littell, Farhills Box 26, Dayton 9, Ohio.

HELP WANTED

INSTRUCTORS in Electronics and Radio. Prefer former Navy Radio Technician instructors willing to locate in the Detroit, Mich., area. Write to Box 452, c/o Radio & Television News, 185 N. Wabash Ave., Chicago, Ill.

RADIO & TELEVISION NEWS

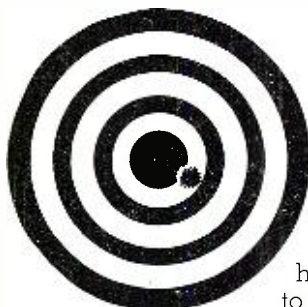

Almost
DOES NOT PAY

A smattering of radio is of no value except as a hobby or to satisfy curiosity. The real pay goes to the man with the First Class FCC License who can deliver the goods. That means that training must not only be thorough but it must be up-to-the-minute training that will pass the test. There is no magic in radio training. You need modern texts, a pleasant atmosphere to pursue your studies, plus topnotch instructors who can anticipate future trends in training requirements. TCC training has been placing qualified radio men in good paying jobs for over 30 years. Our reputation for good training brings us more calls for qualified operators than we can supply. Train now for this great field in the Rose Capital of America where living expenses are low, tuition is reasonable and the climate is mild. Write today for a free catalog. Approved for Veterans Training.

TYLER COMMERCIAL COLLEGE

Room 204 TCC BUILDING, TYLER, TEXAS

CORRESPONDENCE COURSE

USED Correspondence Courses and Books sold and rented. Money back guarantee. Catalog free. (Courses bought.) Lee Mountain, Pisgah, Ala.

USED Correspondence Courses and Educational Books bought, sold, rented, catalog free. Educational Exchange, Summerville, Ga.

PATENT ATTORNEYS

HERMAN Lewis Gordon, Registered Patent Attorney. Patent Investigations and Opinions. Warner Building, Washington, D. C.

LANCASTER Allwine & Rommel Registered Patent Attorneys. Patent practice before U.S. Patent office. Validity and Infringement investigations and opinions. Booklet and form "Evidence of Conception" forwarded upon request. Suite 414, 815 15th St., N.W. Washington 5, D.C.

MISCELLANEOUS

ELECTRONIC Research. Equipment designed or built to specifications. Inventors, experimenters, inquiries invited. E. A. K. Research Laboratory, Box 62, Tarrytown, N. Y.

REVITALIZING receivers. Curing stubborn intermittents, other elusive defects. Common servicing errors. \$1. "Since 1923." Roy's Radio Repair, 703 W. Jackson, Kokomo, Ind.

RADIOMEN. Servicemen, Beginners. Make more money, easily, quickly, \$250 weekly possible. We show you how. Information free. Merit Products, 216-32R 132 Ave., Springfield Gardens 13, N. Y.

RADIO, Television, Electronics Tutoring. \$5 per lesson. Mo. Tech., 3907 N. 25th, St. Louis 7, Mo.

CABLE REACHES ATLANTA

FINAL cable connections were made to Atlanta, Georgia, the last of September making possible the reception of live programs via the TV network.

A city-wide celebration marked the occasion, with Burr Tillstrom and his Kuklapolitan Players as the star attraction.

TECHNICIANS NEEDED

CIVILIAN electronics and communications engineers interested in assignments in the Pacific area with Airways and Air Communications Service (ACCS) have been requested to write the Commanding General, Headquarters ACCS, Washington 25, D. C., Attn: Director of Personnel.

ACCS urgently needs these engineers to fill positions in grades 7 through 12. The ACCS is part of the Military Transport Service and furnishes air communications and navigational flying aids to U. S. military aircraft throughout the world.

PHOTO CREDITS

Page	Credit
39 (top left)	V-M Corporation
39 (center)	Milwaukee Stamping Co.
39 (right)	Zenith Radio Corp.
41 (top)	Lincoln Engineering Co.
41 (bottom)	Pickering and Company, Inc.
44, 66, 67	Jensen Mfg. Co.
50, 51	Allied Radio Corporation
52, 54	Triad Transformer Mfg. Co.
55 (bottom)	Newcomb Audio Products Co.
55 (center)	Rauland Corporation
55 (top left)	Minnesota Electronics Corp.
55 (top right)	Altec-Lansing Corp.
59, 61, 63, 155	Radio Corporation of America
65	Acme
74, 75, 76, 77, 78, 192	University Loudspeakers, Inc.
80, 81	Concord Radio Corporation
83	The Heath Company
87, 88	Cinema Engineering Co.
106	A. Ferron-Barberini, Zermatt, Switzerland
170	MARS
174, 179	General Electric Company
180	Radio Parts Show Corporation
187	Sylvania Electric Products Inc.

ERRATUM

In the short item "Crystal Mount" by Rufus P. Turner, appearing on page 74 of the September issue, the measured capacitance of the holder should have been given as 0.9 micromicrofarads instead of 0.9 microfarads. Sorry we slipped up on this.

**You'll Want this
R. C. A.
15" DUO-CONE SPEAKER**

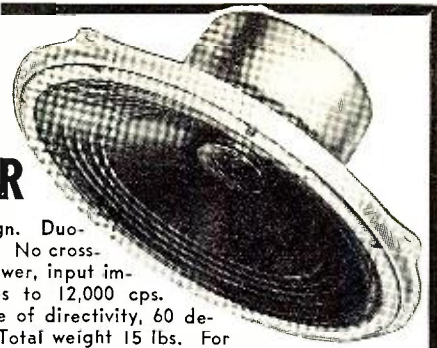

A new advance in high-fidelity speaker design. Duo-cone response without "cross-over" interference. No cross-over network required. Handles 25 watts of power, input impedance 16 ohms, frequency response 40 cps to 12,000 cps. Speaker resonance with baffle, 40-55 cps; angle of directivity, 60 degrees. Equipped with 2 lb. Alnico V magnet. Total weight 15 lbs. For rim or flange mounting in base-reflex cabinet.

RCA 515S2—\$48.50

COMPARES IN QUALITY AND PERFORMANCE WITH OTHER SPEAKERS COSTING 3 TO 4 TIMES THIS AMOUNT

**FREE WITH ORDER
RADIO'S MASTER**

THE ONLY OFFICIAL ELECTRONIC SOURCE-BOOK. SAVES TIME & MONEY

FIFTEENTH EDITION NOW READY, OVER 1,200 PAGES THOUSANDS OF ILLUSTRATIONS, SPECIFICATIONS AND PRICES CROSS-INDEXED FOR EASY HANDLING PERMANENTLY BOUND WITH HARD COVER (PUBLISHER'S PRICE \$5.50)

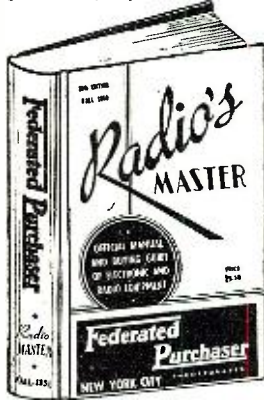

Federated Purchaser INCORPORATED
CABLE: FEDERPURCH
66 DEY ST., NEW YORK 7, N. Y. Dlgby 9-3050

NEWARK, N. J.

ALLENTOWN, PA.

EASTON, PA.

SENSATIONALLY NEW!



MAGNEMASTER* Model 815
Available direct from **\$395** factory at
(Low Impedance Inputs and Input mixing facilities optionally available at extra cost.)

Professional TAPE RECORDER
The **MAGNEMASTER*** Consolette

- Featuring**
- Two-speed two-direction operation!
• 50 to 15,000 cycles at 15 in. per sec.
• 50 to 10,000 cycles at 7½ in. per sec.
 - Dynamic range better than 50 db!
 - Single or dual track recording without changing heads!
 - Simultaneous monitoring off tape while recording (optional)!

Other Magnemaster features include: Separate heads for erase, record and monitor • Guaranteed lifetime head alignment • Shuttle speed in both directions • Synchronized brakes for instantaneous stop • No overshoot or tape spillage during play or shuttle • Flutter ± 0.05% at 15 in. per sec.; ± 0.1% at 7½ in. per sec. • Lifetime self-adjusting spring clutches • Gentle non-slip non-pinching drive system.

Write today for complete literature. *Trade Mark Reg.
AMPLIFIER CORP. of AMERICA
398-2 Broadway, New York 13, N. Y.



INTERLOCKING SMALL PARTS CABINETS TO FIT ANY SPACE

At Last!

MULTI DRAWERS are the handy small parts steel storage cabinets you and your friends have always wanted! Each 5 x 2½ x 2¼ drawer (painted green) interlocks on top, bottom or sides making it possible to fit them around existing fixtures for economy of space. Card holder on front of each MULTI DRAWER. Immediate delivery in sets of 12 at \$3.50 per set. Mail coupon now!

THE CINCINNATI VENTILATING CO., INC.
Third and Madison Sts., Covington, Ky.

Please send _____ sets of MULTI DRAWERS @ \$3.50 per set.
 C.O.D. Check Money order enclosed. I agree to pay postage.

I am interested in being a MULTI DRAWER distributor. Send full information.

Name _____
Address _____
City and State _____

RADAR, COMMUNICATIONS AND SONAR TECHNICIANS

W-A-N-T-E-D For Overseas Assignments

Technical Qualifications:

1. At least 3 years practical experience in installation and maintenance.
2. Navy veterans ETM 1/c or higher.
3. Army veterans TECH/SGT or higher.

Personal Qualifications:

1. Age, over 22—must pass physical examination.
2. Ability to assume responsibility.
3. Must stand thorough character investigation.
4. Willing to go overseas for 1 year.

Base pay, Bonus, Living Allowance, Vacation add-up to \$7,000.00 per year. Permanent connection with company possible.

Apply by Writing to
**D-4, P.O. Box 3575,
Philadelphia 22, Pa.**

Men qualified in RADAR, COMMUNICATIONS or SONAR give complete history. Interview will be arranged for successful applicants.

CAPACITANCE CHECKERS

SOLAR CAPACITOR ANALYZERS

Model CBB—Measures the capacity of any electrolytic, paper, mica or air capacitor between 10 mfd. and 500 mfd. Uses a Wien bridge circuit with a 6E5 tube to indicate balance. Measures the power factor of electrolytic cond. Checks resistance from 100 ohms to 7 meg. and insulation resistances at voltages up to 450 V. DC. Operates on 115 V, 50-60 cps. Complete with tubes. \$4249 Sng. Wgt. 9 lbs.



Model CBB-1—For operation on 110-220 V. 25-60 cps. Your Cost \$55.76

SOLAR MODEL CF EXAM-ETER

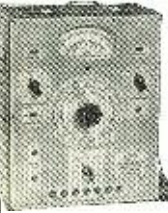

An extremely versatile tester for measuring the capacity, power factor, leakage current and both AC and DC voltage. Wien bridge circuit is used to test capacity with a range of 10 mfd. to 2000 mfd. Measures power factor from 0-50%. Resistance measurements from 100 ohms to 7.5 meg. and insulation measurements from 3-10,000 megs. Leakage tests can be made at voltages up to 550, and read on a milliammeter. VTVM checks voltage 0-600 DC, AC, and HF voltages. Complete with tubes and test leads. Operates on 115V 50-60 cps. \$6995

Your Cost \$6995
20% deposit with order. Balance C.O.D.
JOBBERS—WRITE FOR DISCOUNT

"GASS"—2032—61st St., Brooklyn, N. Y.

INDEX OF Advertisers

NOV.
1950

While every precaution is taken to insure accuracy, we cannot guarantee against the possibility of an occasional change or omission in the preparation of this index.

ADVERTISER	PAGE	ADVERTISER	PAGE
Aaron Electronic Sales.....	168	Mass. Radio School.....	192
Acorn Electronics Corporation.....	150	Midwest Radio & Television Corporation.....	33
Acro Products Company.....	110	Miles Reproducer Company, Inc.....	167
Adson Radio & Electronics Company.....	132	Milwaukee School of Engineering.....	135
Aerovox Corporation.....	160	Murray Hill Books, Inc.....	28, 29
Alliance Manufacturing Company.....	25	McGee Radio Company.....	104, 105
Allied Radio Corporation.....	9, 17	Meintosh Engineering Laboratory Inc.....	123
Altec Lansing Corporation.....	120, 148	National Radio Institute.....	3
Alvaradio Supply Company.....	154	National Schools.....	11
American Electroneering Corp.....	177	New England Television Corp.....	186
American Phenolic Corporation.....	26	Newark Surplus Materials Co.....	142
American Television & Radio Company.....	136	Newcomb Audio Products.....	190
Amperite Company, Inc.....	118	Niagara Radio Supply Corporation.....	113
Amplifier Corporation of America.....	196, 199	Oak Ridge Products.....	197
Arrow Sales, Inc.....	141	Offenbach & Reimus Company.....	161
Ashe Radio Company, Walter.....	121	Ohmite Manufacturing Company.....	10
Atlas Sound Corporation.....	130	Olson Radio Warehouse, Inc.....	108, 109
Baltimore Technical Institute.....	194	Opad-Green Company.....	102
Belden Manufacturing Company.....	31	Onan & Sons, D. W.....	150
Bell Telephone Laboratories.....	34	Peak Electronics Company.....	159
Bond Equipment Company.....	171	Peerless Products Industries.....	193
Boyer-Roche Book Company.....	118	Penn Boiler & Burner Mfg. Corp.....	35
Brocner Electronics Laboratory.....	173	Penn Electronic Parts Company.....	187
Brook Electronics, Inc.....	166	Permotlux Corporation.....	143
Bryonyng Laboratories, Inc.....	164	Pfanstiel Chemical Company.....	124
Brush Development Company, The.....	12, 115	Philco Field Service.....	200
Buffalo Radio Supply.....	145	Phillips Manufacturing Company.....	172
Burden Sales.....	177	Photocon Sales.....	123
Burstein-Applebee Company.....	152	Pickering & Company, Inc.....	176
Candler System.....	190	Platt Electronics Corp.....	188
Cantor, Jack.....	143	Poly-Tech.....	128
Capitol Radio Engineering Institute.....	95, 195	Precision Electronics, Inc.....	186
Cass.....	200	Premax Products.....	186
Central Radio & Television School, Inc.....	189	Premier Radio Tube Company.....	131
Centralab, Division of Globe Union, Inc.....	20, 21	Progressive Electronics Company.....	191
Chelsea Television Center, Inc.....	110	Pyramid Electric Company.....	24
Chicago Industrial Instrument Company.....	134	Quam-Nichols Company.....	190
Chicago Transformer.....	155	R C A Institutes.....	175
Cincinnati Ventilating Company, Inc., The.....	199	R C A Service Company, Inc.....	198
Cleveland Institute of Radio Electronics.....	5	R & T Electronics Co., Inc.....	196
Clippard Instrument Laboratory, Inc.....	160	Radio Apparatus Corp.....	169
Columbia Electronic Sales.....	134	Radio Corporation of America.....	Second Cover, 103, 171
Comet Electronic Sales Company.....	165	Radio Craftman, Inc.....	178
Communications Equipment Company.....	127	Radio Distributing Company.....	175
Concord Radio Corporation.....	36	Radio Ham Shack, Inc.....	137
Coyne Electrical & Television-Radio School.....	181, 191	Radio Parts Company.....	133
DeForest-Sanabria Corp.....	129	Radio Receptor Company, Inc.....	157
De Forest's Training, Inc.....	7	Radio Wire Television, Inc.....	32
DeMambo Radio Supply Co., Inc.....	195	Rauland Corporation.....	6
Door, William H.....	146	Raytheon Television.....	23
Drake Company, R. L.....	138	Red Arrow Sales.....	192
Dumont Laboratories, Allen B.....	Third Cover	Reeves Soundcraft Corporation.....	132, 153
East Coast Electronics.....	152	Reg-O-Kut Company.....	160
Editors & Engineers.....	179	Reliance Merchandising Company.....	187
Eddie Electronics, Inc.....	156	Richford Television Sales Co.....	194
Electro Devices, Incorporated.....	163	Rider, John F.....	146
Electro Products Laboratories, Inc.....	132	Russell Lens Co.....	183
Electro Technical Industries.....	174	Sams & Company, Howard W., Inc.....	101, 112, 158
Electro Voice, Inc.....	96	Schott Company, Walter L.....	157
Electronic Indicator Corporation.....	176	Sherson Electric Company.....	30
Electronic Instrument Company, Inc.....	17	Soundtronics Laboratories.....	128
Electronic Measurements Corp.....	193	Spellman Television Company, Inc.....	120
Electronic Technical Institute.....	182	Sprague Products Company.....	16
Electronic Workshop, Inc.....	196	Sprayberry Academy of Radio.....	19
Electronics Institute, Inc.....	183	Stahl, Michael.....	114
Erie Resistor Corporation.....	146	Standard Transformer Corp.....	169
Espey Manufacturing Company, Inc.....	157	Star Electronics.....	196
Fair Radio Sales.....	189	Stephens Manufacturing Corp.....	184
Federated Purchaser Incorporated.....	199	Sun Radio & Electronics Company, Inc.....	146
Feiler Engineering Company.....	189	Sun Radio of Washington, D. C.....	128
Fisher Radio Corp.....	176	Supreme Publications.....	107
Franklin Technical Institute.....	177	Suplex Sales, Inc.....	196
G. L. Electronics.....	187	Swedgal Radio, Inc.....	193
Garrald Sales Corporation.....	172	Sylvania Electric Products, Inc.....	15
General Electric Company.....	27, 37	TAB.....	117, 202
General Electronic Distributing Company.....	97, 98, 99, 100	Talk-A-Phone.....	183
General Test Equipment.....	185	Tech Master Products Company.....	152
Gonset Co.....	166	Tekni-Labels Company.....	182
Good Inc., Don.....	186	Telex.....	175
Goodheart, R. E.....	143	Television Communications Institute.....	193
Greenlee Tool Co.....	191	Television Supply Company.....	138
Hallcrafters Company, The.....	38	Telex, Inc.....	132
Harvey Radio Company, Inc.....	170	Telrex Inc.....	116
Heath Company, The 87, 88, 89, 90, 91, 92, 93.....	197	Thomas Electronics, Inc.....	181
Henry Radio Stores.....	197	Trad Television.....	182
Henshaw Radio Supply.....	177	Transvision, Inc.....	164
Hudson Radio & Television Corp.....	201	Tri-State College.....	167
Hy-Grade Electronics, Inc.....	102	Triad Transformer Manufacturing Company.....	94
Hytron Radio & Electronics Corp.....	13	Trio Manufacturing Company.....	175
Illinois Condenser Company.....	150	Triplett Electrical Instrument.....	129
Indiana Technic College.....	185	Tung-Sol Lamp Works, Inc.....	119
Instructograph Company.....	182	Tyler Commercial College.....	198
J. F. D. Manufacturing Company, Inc.....	122	Ungar Electric Tool Company, Inc.....	120
Jackson Electrical Instrument Co.....	147	Universal Microphone Co.....	122
Jensen Manufacturing Company.....	14	University Loudspeaker, Inc.....	18
Knepper Aircraft Service.....	118	V & H Radio & Electronic Supply.....	185
La Pointe Plasmocold Corporation.....	144	Valparaiso Technical Institute.....	143
Leotron Research Laboratories.....	133	Waldom Electronics Inc.....	164
Leotone Radio Company.....	134	Ward Products Corporation.....	173
Loris Sales.....	179	Weller Electric Corp.....	8
Lormel Products Company.....	188	Wells Sales, Inc.....	125
MacMillan Company.....	162	Wholesale Radio Parts, Inc.....	180
Mallory & Company, P. R.....	Fourth Cover	Workshop Associates, Inc.....	151
Martin Manufacturing Company.....	167	World Radio Laboratories, Inc.....	167
		Ziff-Davis Publishing Company.....	111, 139, 149

Technical BOOKS

"DATA AND CIRCUITS OF RECEIVER AND AMPLIFIER VALVES," a Symposium. Published by *Philips Industries*, Eindhoven, Holland. Distributed by *Elsevier Publishing Co.*, New York. 409 pages. Price \$2.75.

This book is an elaborate and comprehensive "tube manual" covering receiver, amplifier, and rectifier tubes manufactured by *Philips Industries* during the years 1933-1939. Similar publications have made their appearance in the Dutch, French, and German languages but this is the first time that the company has made this book available in English.

The text supplies full technical data and characteristics on the latest *Philips* receiving, amplifying, and rectifying tubes, current regulators and stabilizers and tabular data on other types of receiving and rectifying tubes, as well as electronic tubes (cathode-ray, photoelectric cells, etc.).

The book is roughly divided into two sections, the first covering a.c. tubes, a.c.-d.c. tubes, power output tubes and microphone preamplifier pentodes, rectifying tubes for amplifiers, current regulators and stabilizers, as well as special purpose tubes of various types. The second section contains circuits for a.c. receivers, a.c.-d.c. sets, battery-operated receivers and small phono amplifiers. A special section deals with the various types of *Philips* test equipment for radio and electronic applications.

While the British terminology has been used throughout the text, persons using this book should experience very little difficulty in making the transition to American usage. Designers, service technicians, hams, and students will all find plenty of valuable information in their particular fields included in this publication.

Other books in this *Philips* Technical Library series are currently available or are in the process of preparation.

* * *

"TV INSTALLATION TECHNIQUES" by Samuel L. Marshall. Published by *John F. Rider Publisher, Inc.*, New York. 326 pages. Price \$3.60.

The critical shortage of good and practical handbooks covering the proper installation of television receivers and their related antenna systems has been relieved to some extent during the course of this year by the publication of several excellent texts. However, the literature covering this important subject is far from complete and the addition of this new book will undoubtedly be hailed by technicians as a real boon.

Probably the outstanding contribution of this text is the fact that all of the material is *practical*. The author, himself a practicing radio man, hasn't cluttered up his book with a lot of

theoretical material. Everything in the book is there because it meets some need of the technician for information on the "why's," "how's," and "wherefore's" of making a good and safe television antenna installation.

Major emphasis has been placed on the mechanics of installation. Even such often-neglected subjects as ice loading, wind surfaces, proper means of guying, etc., come in for their share of attention. The book is divided into nine chapters covering the nature of television, radio propagation, antennas, transmission lines and special antennas, materials and methods used in installations, high masts and tower installations, receiver adjustment and service in the home, and municipal regulations. A fairly comprehensive

appendix covers television station listings, specifications on the various types of antenna lead-ins, anchor specifications, a conductor table, a tabulation of the safe loads for standard bolts, a tap and drill chart, picture tube characteristics, basing diagrams, a decibel conversion chart, a transmission line attenuation graph, a twin-lead nomograph, and instructions on the correct way to administer artificial respiration (a "must" working tool for all persons working in television).

Television technicians would do well to add this book to their tool kits as it provides all of the answers to those tricky installation problems so often encountered.

-30-



TWO NAMES YOU CAN ALWAYS DEPEND UPON

For Quality and Service!





- ★ **RCA for Top Quality Equipment!**
- ★ **HUDSON for Best Value — Dependable Service!**

Order by Mail or Phone, or Shop In Person at New York's Newest Radio, TV and Sound Equipment Supply House . . . 3 Great Floors featuring a Complete Line of RCA Tubes, Parts, Batteries, Test Equipment and Speakers!

NEW! RCA 515S2 15" Duo-Cone SPEAKER

Sensational development of Dr. H. F. Olson, famous RCA speaker authority. This new 15" Dual-Cone Loudspeaker provides amazing life-like reproduction at a moderate price! Delivers 25 watts of high fidelity audio from 40-12,000 cps over 60° angle. Has 2 voice coils, each driving one of the duo-cones, which vibrate as a single cone, at crossover frequencies (around 2,000 cps), avoiding "crossover" interference. Requires no cross-over network. 16 ohms. 2 lb. Alnico V magnet. Resonance (with baffle) 40-55 cps. 18 lbs.

No. A53, RCA 515S2 Speaker.....Net **\$48.50**
Includes 2% discount.

RCA Model 515S1, No. A52, 15" Duo-Cone Speaker. 18 lbs. Net \$35.57

RCA TELEVISION COMPONENTS

All RCA Television Components are "originals," designed with characteristics which are correct both electrically and mechanically for the tubes and circuits. They are "performance" proved and competively priced!



RCA INDUSTRIAL TUBES — Value Beyond Price!

RCA's unparalleled research facilities, engineering background, and manufacturing experience contribute to the quality, dependability, and operating economy of EVERY RCA tube you buy. The Quality of RCA tubes is Unquestioned!



FREE!
SEND FOR OUR
NEW 1951
CATALOG



212 FULTON ST.
NEW YORK 7, N.Y.
Digby 9-1192

Hudson Radio & Television Corp. Dept. 11R
212 Fulton St., New York 7, N. Y.

Please send: 515S2 Speaker
 Full Payment Enclosed
 Down Payment (10%)
 SEND FREE HUDSON CATALOG—Just Out!

Name.....

Address.....

City.....Zone.....State.....

**Most Complete Stock of Radio, Television,
Electronic and Sound Equipment in the East!**

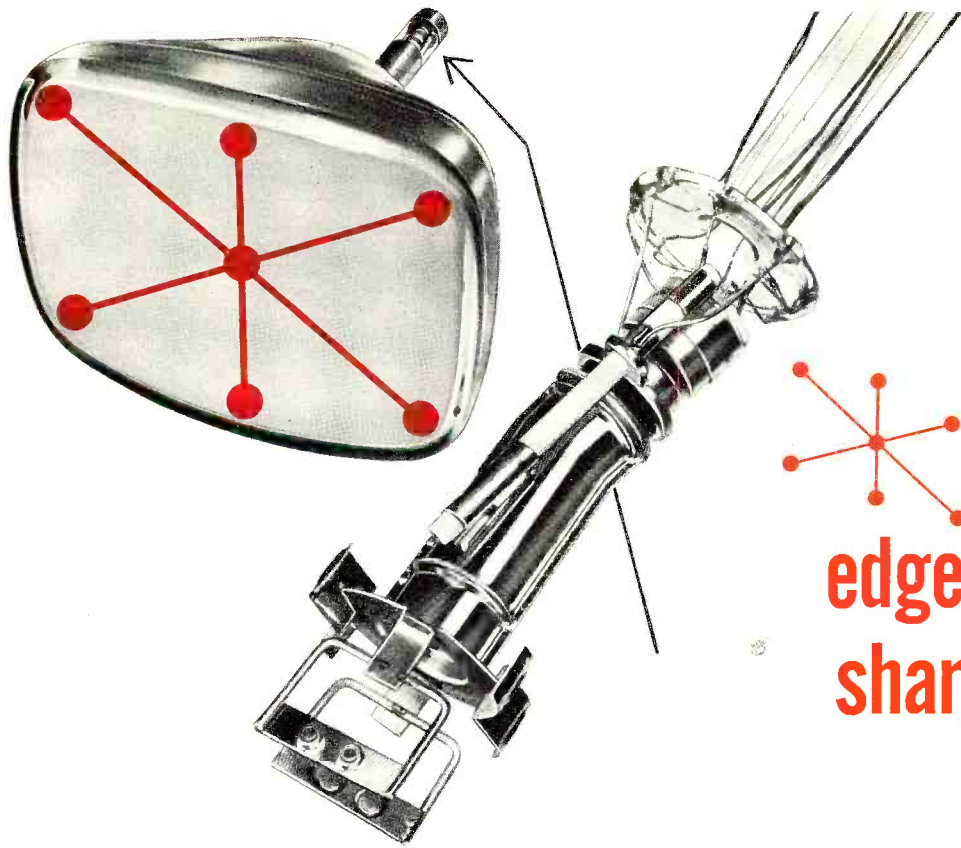

for
edge to edge
sharpness...

the **New** Du Mont Bent-Gun

Uniform sharpness of trace to the very edges of the screen distinguishes the new Du Mont Bent-Gun.

A higher degree of pre-focusing passes a smaller-diameter beam through the deflection field. Spot distortion is reduced and a uniform overall focus results. Other design changes are: Improved bulb spacer insures proper anode contact and electron gun centering; rounded corners on pertinent gun parts eliminates stray emission at higher anode voltages; new grid-cathode assembly allows a longer G-2 (second grid) without increasing overall length.

This new Du Mont Bent-Gun is now being incorporated in ALL Du Mont Teletrons. Therefore, whether planning a new TV receiver or modifying an old one, be sure to include the Du Mont Teletron for the best in TV pictures. Simply specify DU MONT.

FIRST WITH THE FINEST IN **T-V** TUBES

DU MONT

*Teletrons**

ALLEN B. DU MONT LABORATORIES, INC.,
Tube Division, Clifton, N. J.

*Trade-mark.



No Need To Worry About Moisture When You Use The MALLORY PLASCAP*

MALLORY FP CAPACITORS

When you select Mallory FP Capacitors, you can be sure of their performance even in circuits where heat is a problem. Every Mallory FP Capacitor will operate continuously at 85° C. In addition, Mallory FP Capacitors are famous for their long shelf-life... you can depend on them when you need them. Buy the one line that services both AM and TV sets. They are an outstanding example of Mallory Precision Quality at standard prices.

See your Mallory Distributor right away!



The Mallory Plascap plastic tubular capacitor exceeds R.M.A. requirements for humidity and immersion tests . . . even for metal-cased capacitors. It's the plastic tubular that's years ahead of the rest of the field.

No oil leakage, no unsoldered leads, no messy wax coating, no insulation problems! Check these four exclusive features which make your service jobs surer and easier:

- **TRISEAL CONSTRUCTION.** Sealed three ways . . . with moisture-free Mallocrol, tough outer plastic shell, exclusive Mallocene!
- **FASTITE LEADS.** Permanently fastened . . . sealed with Mallocene . . . unaffected by soldering-iron heat!
- **DISTORTION-FREE WINDING.** No flattened cartridges due to molding pressures . . . no failures due to "shorts"!
- **TRU-CENTER CARTRIDGES.** Cartridges centered every time . . . uniform insulation guaranteed at all points!

You don't have to handle the Mallory Plascap with kid-gloves . . . it is built to "take it"! See your Mallory Distributor, now. Remember, you pay no more for Mallory Precision Quality!

*Trade Mark

P. R. MALLORY & CO., Inc.
MALLORY

CAPACITORS • CONTROLS • VIBRATORS • SWITCHES • RESISTORS
• RECTIFIERS • VIBRAPACK* POWER SUPPLIES • FILTERS

Reg. U. S. Pat. Off.

APPROVED PRECISION PRODUCTS

P. R. MALLORY & CO., Inc., INDIANAPOLIS 6, INDIANA